

JULY, 1924

25 CENTS

# RADIO

(Reg. U. S. Pat. Off.)



W. H.  
ANDREWS

# Cunningham

## RADIO TUBES

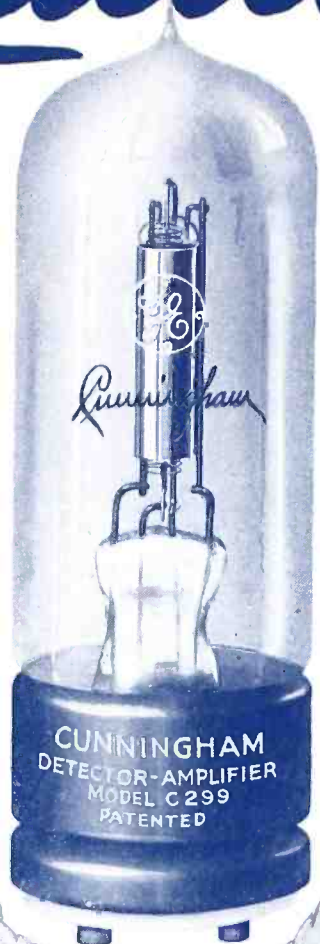

### The Ideal TUBE for Vacation Time

AT the seashore—in one of our great national parks, or while motoring you will find the Cunningham Dry Battery Detector and Amplifier, Type C-299, the ideal Tube for your portable receiving set.

The special filament of this tube having a current so low that it may receive its supply from standard No. 6 Dry batteries or even from ordinary flashlight batteries, makes possible this entertaining application of Radio in places far remote.

Your dealer can give you useful suggestions for the purchase or construction of a highly efficient and practical portable Radio Set. Make this a Radio summer.

#### Cunningham C-299 Detector and Amplifier Tube

C-299 3 volts .06 amp. Dry Battery  
Detector and Amplifier .....\$5.00

#### Other Cunningham Radio Tubes

C-301A—6 Volts 1-4 amp. Amplifier.....\$5.00  
C-300—6 Volts Gas Content Detector.....\$5.00  
C-11—1.1 Volts .25 amp. Dry Battery  
Detector and Amplifier, Special Base...\$5.00  
C-12—Similar to C-11 with standard base.\$5.00

**Patent Notices** Cunningham tubes are covered by patents dated 2-18-08, 2-18-12, 12-30-13, 10-23-17, 10-23-17 and others issued and pending. Licensed for amateur, experimental and entertainment use in radio communication. Any other use will be an infringement.

Cunningham 40-page Data Book fully explaining care and operation of Radio Tubes now available by sending 10c in stamps to San Francisco office.

*E. J. Cunningham Inc.*

Branch  
CHICAGO

Home Office:  
182 Second Street  
SAN FRANCISCO

Branch  
NEW YORK

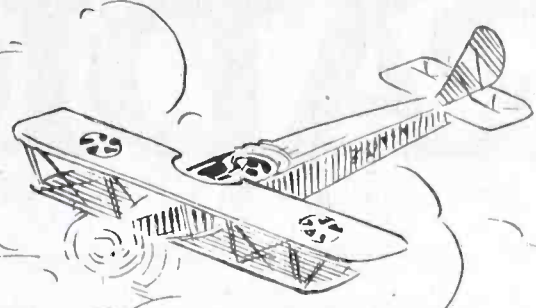
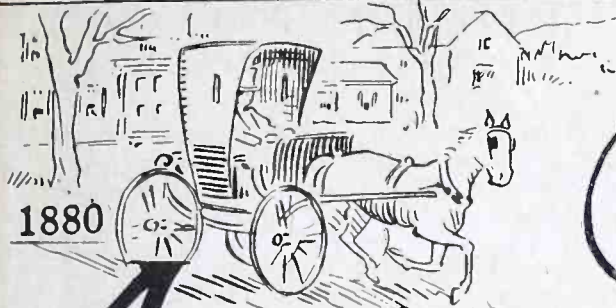

*American Genius*

*TO-DAY*

# IN RADIO HEADSETS

As in Transportation, American Genius has progressed from the old-fashioned, clumsy, obsolete phones of uncertain accuracy to the modern

## TOWER'S SCIENTIFIC HEADSET

Lightest of all in weight, higher resistance, with elimination of distortion. Longer cord (full 5 ft.)

With increased production follows price reduction. As the **LARGEST EXCLUSIVE MFGRS.** of headsets in **THE COUNTRY**, we are able to produce the **TOWER'S SCIENTIFIC** Headset at the low price of \$2.95.

Companies of more limited production could not afford to sell such quality phones at anywhere near this price.



*Formerly \$6*

**\$2.95**

*Plus a few Cents Postage*

# YOUR PROTECTION

Every set tested and approved by licensed radio operators. Every set covered with money-back guarantee.

Production, over one million double headsets for this season.

Order at once by post card and we will ship immediately by Parcel Post C. O. D.

# THE TOWER MFG. CO.

98 <sup>Dept.</sup> E Brookline Ave, Boston, Mass.



Tell them that you saw it in RADIO

# RADIO

Established 1917 as Pacific Radio News

Volume VI

for JULY, 1924

Number 7

## CONTENTS for JULY, 1924

Radiatorial Comment .....	9
Locating Ship Positions by Sound and Radio, <i>By S. R. WINTERS</i> ....	10
Experiments with Short Wave Transmission.....	12
The Reception of Radio Waves, <i>By C. M. JANSKY, JR.</i> .....	13
What Music The Radio Public Wants, <i>By ARTHUR S. GARBETT</i> ....	15
A Three-Tube Reflex Receiver, <i>By PAUL OARD</i> .....	17
Theory of the Reflex Circuit, <i>By L. R. FELDER</i> .....	20
Effect of Tube Capacitance and Resistance, <i>By WALTER EMMETT</i> ...	22
A Radio Piracy, <i>By HARRY P. BRIDGE, JR.</i> .....	23
"Six Cylinder" Magnetic Control for C. W. Transmitters.....	25
<i>By DR. A. E. BANKS</i>	
Reducing Transmitter Interference, <i>By E. T. JONES</i> .....	27
Neutralization of Tuned Radio-Frequency Amplifiers.....	28
<i>By THOMAS W. BENSON</i>	
The Plate-Tuned Revamped Again, <i>By L. W. HATRY</i> .....	29
The Finger of God, <i>By B. W. FORDHAM</i> .....	30
Direction Finding for the Amateur, <i>By WALLACE KELK</i> .....	31
Eliminating Interference from Cottrell Precipitator.....	32
<i>By COL. J. F. DILLON</i>	
Radio as A Stabilizer of Government, <i>By B. G. HUBBELL</i> .....	32
Improvements in The Best 45,000-Cycle Super-Heterodyne.....	33
<i>By G. M. BEST</i>	
Crystal versus Vacuum Tube, <i>By JEROME SNYDER</i> .....	34
Finding The Natural Period of The Antenna, <i>By C. H. CAMPBELL</i> ..	35
Letters from a "Lid".....	35
Vacuum Tube Data, <i>By G. M. BEST</i> .....	36
Queries and Replies, <i>By G. M. BEST</i> .....	37
Letters To The Editor.....	39
Radio Railway Dispatching.....	40
With The Amateur Operators.....	41
From The Radio Manufacturers.....	42
Australian Notes, <i>By L. S. LANE</i> .....	64
New Zealand Radio Calls.....	68
Constant Wave Aircraft Transmitter and Receiver.....	69
<i>By S. R. WINTERS</i>	
A Selective and Efficient Tuner, <i>By H. T. GALLAHER</i> .....	70

RADIO is Published Monthly by the Pacific Radio Publishing Co., Inc., Pacific Building, San Francisco, Calif.

ARTHUR H. HALLORAN .....	Editor
LAWRENCE MOTT .....	Associate Editor
GERALD M. BEST .....	Technical Adviser
H. W. DICKOW .....	Advertising Manager

Branch Offices: 17 West 42nd St., New York City, Telephone Longacre 8248; 157 E. Ontario St., Chicago; 761 Spitzer Bldg., Toledo, Ohio; 52 5107; 1102 Republic Bldg., Kansas City, Mo.

European Representatives: Compagnie Universelle De Representation wt de Commerce. Rue des Fortifications, 69, Anvers, Belgium.

Advertising Forms Close on the First of the Month Preceding Date of Issue.

Issued Monthly, 25c a copy. Subscription price \$2.50 per year in the U. S., \$3.00 per year elsewhere. Instructions for change of address should be sent to the publisher two weeks before the date they are to go into effect. Both old and new addresses must always be given.

Entered as second-class matter at the Post Office at San Francisco, Calif., under the Act of March 3, 1879.

Copyright 1923, by the Pacific Radio Publishing Co., Inc.

## Forecast of Contributions for August Issue

Professor C. M. Jansky Jr. will next discuss the use of an electron tube as an amplifier, as a detector and as a generator of high-frequency currents.

Brainard Foote gives some well-illustrated details on the construction of "A Receiver Designed for Quality." He uses one stage of tuned r.f., crystal detector and two stages of a.f. amplification.

Don C. Wallace, winner of the 1923 Hoover Cup, has a good article on "Filament Filter Systems." This is the first of a number of contributions from Mr. Wallace.

Samuel G. McMeen records his experience with a home-made Poulsen telegraphophone for making permanent records of things heard over the radio.

The fiction feature will be a humorous story entitled "For King and Radio," by Earl Ennis. Walter Black has also done into English a funny account of "How Radio Came To Cambridge."

R. Lewis Rockett has a timely article on "A Two-Tube Portable Circuit for Summer Use," employing the Flewelling circuit.

Paul Oard's article on "Construction of Power Amplifying Transformers," scheduled for July, will appear in the August number.

Edward T. Jones follows up his article on reducing transmitter interference with one on "The Truth About Rectifier-Filter Systems."

Col. J. F. Dillon gives a simple and lucid explanation of why permanent magnets instead of electromagnets are used in telephone receivers.

Wallace Kelk, who is stationed at the Pachena Point (B. C.) direction finding station, concludes his discussion on "Direction Finding for the Amateur" with detailed directions for calibration.

Kennard McClees gives some excellent advice on tuning for the novice in his "Notes on Receiving Station Operation."

L. R. Felders' illuminating series of discussions on the theory of the standard circuits is brought to a close with "What Makes A Good Receiver," an analysis of the several features which should be examined by the purchaser.

The amateur will be especially interested in F. S. Huddy's account of "A Practical Spark-Coil I. C. W. Transmitter."

H. W. Hatry describes the construction of a set for receiving the 94-meter broadcasts.

G. M. Best is testing about thirty audio-frequency transformers with reference to their impedance characteristics. It is hoped that these data will be available for the August issue. Several good improvements in his super-heterodyne have already been received and the prize-winning ideas will be published.

Jacques Avon has resurrected the electrolytic detector and tells how with it he has secured results surpassing the crystal detector.



# GREBE

## INDIVIDUAL SHIELDS

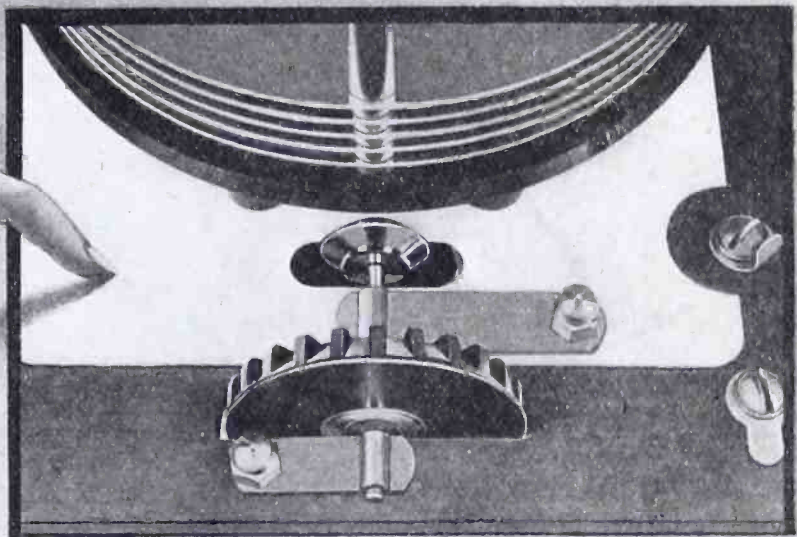

*"The Sage attends to the inner and not to the outer."  
—Lao Tzu*

*The wise buyer of a radio receiver is not misled, he looks inside the cabinet.*

*Doctor Mu*



CLOSE inspection of many receivers reveals but one large shield to prevent body-capacity effects. As a result of research, each tuning control on a GREBE Receiver has its own aluminum shield of special size and shape.

This is just one of many details of craftsmanship which make for the high efficiency of GREBE Receivers.

*Ask your Dealer or write us.*

A. H. GREBE & CO., Inc.  
Van Wyck Blvd. Richmond Hill, N. Y.  
Western Branch: 451 East 3rd Street, Los Angeles, Cal.

Grebe Regenerative Receivers are licensed under Armstrong U.S. Pat. No. 1,113,149.

Tell them that you saw it in RADIO

# PULLING POWER

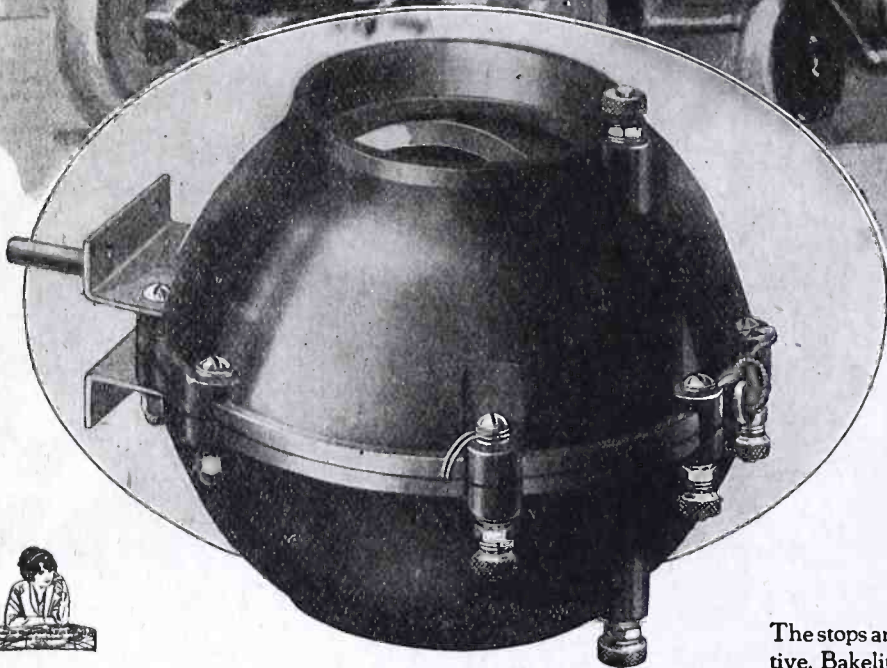

Heavy Bakelite shells of rich brown color. Windings of correct gauge wire and properly proportioned for best reception. Large bearings assure smooth operation and long life. No sliding contacts; rotor connections made with special flexible wires, through hollow shaft to binding posts on stator shell.

The stops are a part of the stator and rotor and are positive. Bakelite especially treated to prevent distributed capacity. Arranged for either panel or base mounting.

## VOLUME!

**T**HE variometer or variocoupler is responsible for the strength of the signals received. Therefore, the size, shape, gauge of wire and number of turns in the Kellogg variometers and variocouplers are the result of exhaustive tests for equipment that will give the best radio reception.

Therefore, it is to your advantage to demand Kellogg variometers and variocouplers and know that you will receive better reception, resulting in maximum entertainment, and value from your radio set.

If your dealer does not handle Kellogg, communicate direct with us.

### KELLOGG SWITCHBOARD & SUPPLY CO.

*1066 West Adams Street, Chicago*



# MAGNAVOX

## The Reproducer Supreme with a Human Throat

The marvelous semi-dynamic mechanism of M4 shown in sectional view at right.

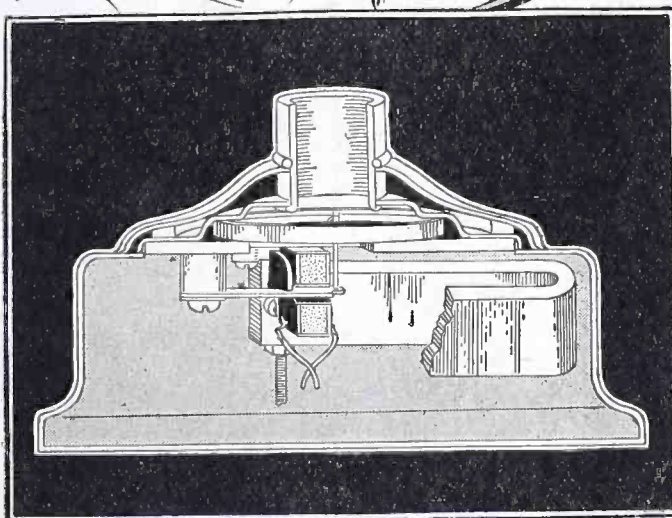

**B**ETWEEN Magnavox and ordinary "loud speakers" there are certain essential differences hidden away in the base of the instrument, insuring for Magnavox utmost clearness of tone.

The quality of radio speech or music is largely determined *before* the sound enters the horn—which makes it so important to select a Reproducer on account of its scientific construction, not merely its outward appearance.

Among instruments operated without a battery, nothing compares with the clear, sweet tone, always true in pitch, produced by the new Magnavox M4.

With the R3 and R2 Reproducers the user secures the advantage of perfect *volume control*—an exclusive feature which greatly increases the enjoyment of radio reception.

The strongest guarantee of mechanical excellence is the Magnavox trade mark — always look for it.

### Reproducers

M4—the latest Magnavox achievement: requires no battery . . . . . \$25.00

- M1—also constructed on the semi-dynamic principle, requiring no battery . . . . . \$30.00
- R3—famous electro-dynamic type: new model with Volume Control . . . . . \$35.00
- R2—same as R3 but larger size: new model with Volume Control . . . . . \$50.00

### Combination Sets

A1-R and A2-R—the only instruments combining electro-dynamic Reproducer and Power Amplifier in one unit . . . . . \$59.00, \$85.00

### Power Amplifiers

A1, AC-2-C, AC-3-C—the most efficient audio-frequency Amplifiers: one, two and three stage \$27.50 to \$60.00

To obtain the fullest enjoyment from your receiving set, equip it with the Magnavox — for sale at good dealers everywhere.

**THE MAGNAVOX COMPANY**  
OAKLAND, CALIFORNIA

New York Office: 350 West 31st Street

Canadian Distributors:  
Perkins Electric Limited, Toronto, Montreal, Winnipeg



# Remler

## SUPER-PARTS



Remler Type 610  
Tuned Stage Trans-  
former  
Price \$5.00



Remler Type  
620 Coupling  
Unit  
Price \$3.00



Remler Type 600  
Intermediate  
Frequency Trans-  
former  
Price \$6.00

## FOR 45,000 CYCLE WORK

*Use REMLER Super-Parts Because*

They are designed and built by Remler.

The Type 600 Intermediate Frequency Transformer and the Type 610 Tuned Stage Transformer work with maximum efficiency at a frequency of 45,000 cycles. Higher frequencies tend toward instability—lower frequencies may result in distortion.

The Type 620 Coupling Unit has been designed to work with maximum efficiency when used with the Remler Transformers.

Remler Super-Parts are designed to give maximum efficiency when used with the C-299 Tube.

Remler Super-Parts require no stabilizer.

Remler Super-Parts permit the use of a C Battery in the intermediate amplifier circuit, thus giving maximum output from the tubes.

Remler Super-Parts have been designed to form a complete Super-Set that is extremely simple to operate, ultra-selective and super-sensitive.

Write for descriptive literature on the construction and use of these famous Remler Super-Parts.

If your dealer or distributor does not carry a stock of these Remler Parts, send us his name and address and your initial order for direct shipment.

List prices:

3 Type 600 I F Transformers.....	\$18.00
1 Type 610 T S Transformer.....	5.00
1 Type 620 Coupling Unit.....	3.00
8 Type 399 Sockets.....	6.00
<b>Total.....</b>	<b>\$32.00</b>

Terms:

Dealers..... Regular discounts,  
Cash or C.O.D.  
Individuals..... Cash with order  
Bulletin No. 60 describing the use of  
these Remler Super-Parts will be mailed  
free of charge upon request.

## Remler Radio Manufacturing Co.

Branch  
Chicago

Home Office  
182 Second Street  
San Francisco

Branch  
New York

Tell them that you saw it in RADIO



# CROSLEY

Announcing — The New Models — each a leader in its line



Crosley Trirdyn 3R3, \$65.00

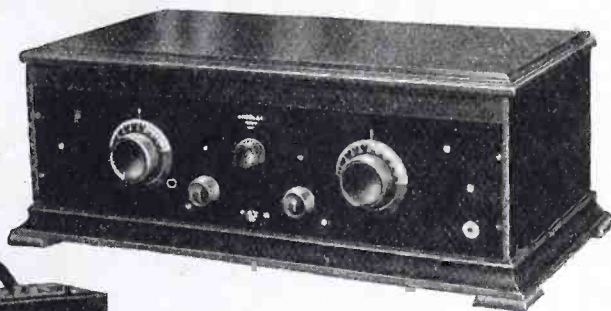

Crosley Trirdyn 3R3 Special, \$75.00

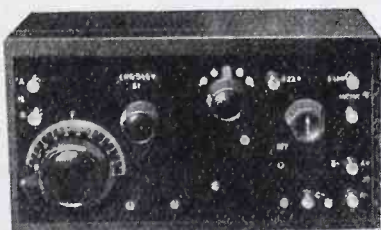

Crosley 51, \$18.50



Crosley 51-P Portable, \$25.00

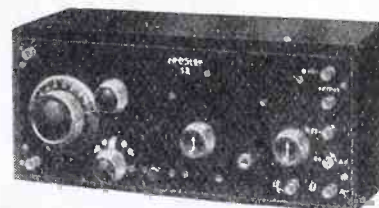

Crosley 52, \$30.00



Crosley 51-A, \$14.00



Crosley 50, \$14.50



Crosley 50-A, \$18.00

## Guaranteed Satisfaction at a Reasonable Price

**CROSLEY 50** A new one tube Armstrong Regenerative Receiver. We believe this to be the most efficient one tube receiver ever put on the market. Uses any standard storage battery or dry cell vacuum tube. Price \$14.50.

**CROSLEY 50-A** A new two stage Audio Frequency Amplifier to match the new Model 50 Receiver. When used in connection with the Crosley Model 50 Receiver, it gives the equivalent of a three tube regenerative receiver. Price \$18.00.

**CROSLEY 51** In twenty-four days this receiver became the biggest selling radio receiving set in the world and it holds that position today. Will bring in local stations on the loud speaker at all times and distant stations under favorable conditions. Price \$18.50.

**CROSLEY 51-A** A new one stage Audio Frequency Amplifier to match the Model 51 Receiver. Combined they give the equivalent of a three tube receiver. Price \$14.00.

**CROSLEY 52** A new three tube Armstrong Regenerative Receiver. Provides loud speaker volume on distant stations under practically all conditions. Price \$30.00.

**CROSLEY 51-P** This is our new portable set. It is the Crosley Model 51 two tube receiver mounted in a leatherette covered carrying case, batteries and all self-contained. Price \$25.00.

**CROSLEY TRIRDYN 3R3** This three tube receiver gives the efficiency and volume of a five tube receiver. We believe it is the most efficient receiver on the market at any price for bringing in long distance stations. Price \$65.00.

**CROSLEY TRIRDYN 3R3 Special** This receiver is exactly the same as the Trirdyn 3R3 except the solid mahogany cabinet is larger to contain "A" and "B" Batteries required when standard dry cell tubes are used. Price \$75.00.

*Prices west of Rockies 10% higher than quoted above.*

Write for descriptive circular.

For Sale by Good Dealers Everywhere.

**THE CROSLEY RADIO CORPORATION**

719 ALFRED STREET

Powel Crosley, Jr., President

CINCINNATI, OHIO

Licensed under Armstrong  
U. S. Patent No. 1,113,149

Crosley Owns and Operates  
Broadcasting Station W L W

**CROSLEY**  
Better - Cost Less  
Radio Products

Tell them that you saw it in RADIO

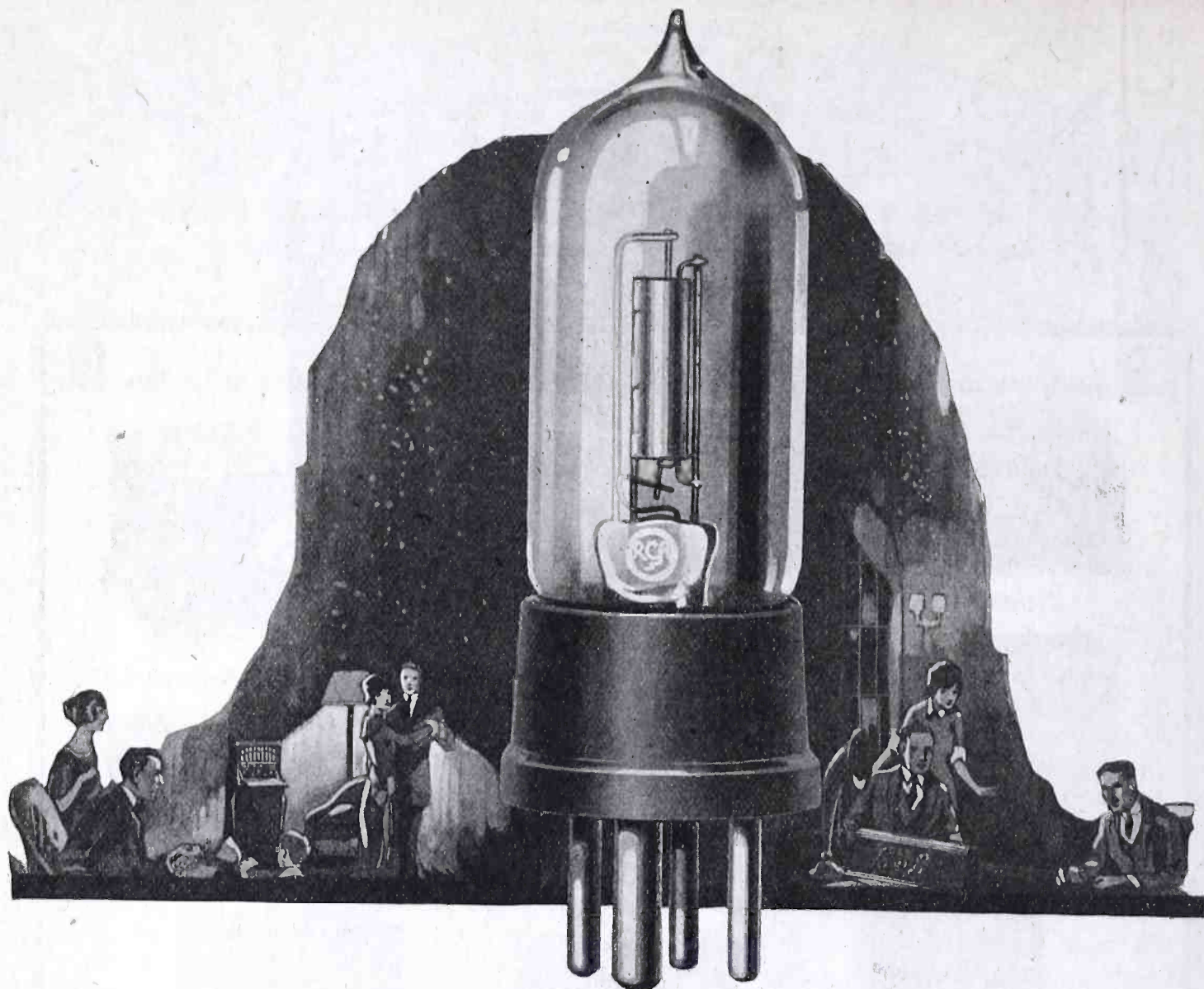

# Is it Genuine ?



*This symbol of quality is your protection*

## RADIOTRONS

Radiotron WD-11 \$5.00

Radiotron WD-12 \$5.00

Radiotron UV-199 \$5.00

Radiotron UV-200 \$5.00

Radiotron UV-201-A \$5.00

**T**HAT is the question every radio dealer hears today. "Is it a genuine Radiotron?" Be sure to look for "RADIOTRON" and the RCA mark on the vacuum tube—to be certain of clear reception and long service. There is a Radiotron for every type of receiver. Ask for the one you want by its name. *And be sure you get it!*

*Send for free booklet that describes all Radiotrons giving their characteristics and circuit diagrams*

Radio Corporation of America

*Sales Offices:*

233 Broadway, New York

10 So. La Salle St., Chicago, Ill.

433 California St., San Francisco, Cal.

RADIO CORPORATION OF AMERICA  
Dept. 57 (Address office nearest you.)  
Please send me your free Radiotron Booklet.

Name \_\_\_\_\_

Street Address \_\_\_\_\_

City \_\_\_\_\_ R.F.D. \_\_\_\_\_

State \_\_\_\_\_

# Radiotron

REG. U. S. PAT. OFF.

Tell them that you saw it in RADIO

July  
1924

# RADIO

Established 1917

Trademark Registered U. S. Patent Office

Volume 6  
No. 7

## Radiatorial Comment

**T**HE resistance-coupled amplifier is again becoming popular after being eclipsed for ten years by transformer coupling of vacuum tubes. Likewise the candle is becoming more popular than the incandescent lamp for aesthetic lighting. In fact if the candle had just been invented it would be hailed as superior to the Mazda lamp in portability, convenience and economy.

But the resistance coupled amplifier adds neither to portability, convenience nor economy. It merely improves the quality of sound reproduction at the expense of more tubes and batteries. It is essentially a home B.C.L. outfit for the person to whom the expense of tubes and B batteries means nothing.

The added tubes and inserted high resistances that are necessary to give the amplification otherwise obtainable with transformers causes a tremendous drain on the batteries supplying plate potential. So that it is not only necessary to have more batteries to supply a higher voltage but also necessary to renew the dead batteries oftener. Thus does the old law of compensation get in its deadly work. What you gain in one thing you lose in the other. You can have whatever you want if you are prepared to pay the cost.

Yet, in all justice, this kind of a set is ideal for the person content to stay at home and not travel all over the country in search of radio entertainment. For many people distance has lost its loathed enchantment and quality of reproduction of home-town radio music is paramount. Resistance-coupling will be more satisfactory to those until such time as the radio engineers further improve the amplifying transformer.

**R**ADIO enthusiasts are criticized by the uninitiated because of their abbreviated linguistic manipulations. Their lingo is not understood. And most people are suspicious of what they don't understand.

Our candid advice is that the ignorant ones learn this radio shorthand. There is an undeniable joy in using this jargon. These nicknames are an evidence of familiarity with what was unknown to the past generation. Furthermore, just as two or three slang words can picture an idea better than a whole paragraph, so does the radio idiom more succinctly express what is meant.

A few of the commoner abbreviations, which everybody should learn, indicate our meaning. Why say "broadcast listener" when we can get the thought over with "BCL"? The whole story of the "Amateur radio operator" is condensed into "ham." If you are continually using and talking about "continuous wave transmission" you can save time by saying and writing "CW." Think of the economy of using "MF" or "mfd" for microfarad, "milli" for milli-ampere, or "DX" for long distance reception.

Besides these common expressions there is a long list of "Q" abbreviations that are used as conventions in international radio telegraphy and are equally applicable in radio telephone or broadcast reception. Thus we have "QRM" to designate interference, "QST" as a general call to all

stations, "QSL" as an acknowledgment that signals have been received, and "QRN" to mean interference from static.

But just as the novice might well become familiar with this amateur vernacular, so should both the novice and the amateur learn something of the engineers' shorthand expressions in mathematics. This is a rapid age, and whatever contributes to speed of thought and action is being adopted.

**R**ADIO magazines, and particularly the newspaper radio supplements, have been giving wide publicity to Major General Squier's proposal to modify the standard telegraph code and method of current supply so as to speed up transmission over wire, cable and radio systems. Whereas the International Morse Code differentiates between dots and dashes by varying the time element involved, the Squier proposal would correspondingly vary the intensity of a continuous wave of alternating current. Technically speaking, he modulates CW with a small amplitude to represent a dot, a medium amplitude for a dash, and a large amplitude for a space. To employ this new method at its highest efficiency, needs a new code, new types of sending and receiving equipment, and new operating methods, all to acquire a much-to-be-desired increase in speed.

If these changes were adopted in commercial practice they would also eventually become standard among the amateurs. Consequently they are of general interest and worthy of careful consideration.

Thus far most of the publicity has been given to the obvious arguments in favor of the change. Recently, however, Harry Nyquist of the American Telephone & Telegraph Company's Department of Research has published a thorough analysis and comparison of the present and proposed systems wherein he concludes that waves produced by sending rectangular signal elements give a stronger received current and less interference with other circuits than does a sine wave of varying intensity. The present method causes a more positive response in the receiving equipment and less distortion in signals. In view of these practical conclusions by such an authority there does not seem to be much likelihood of the early adoption of the Squier plan.

**T**HE first of the coming Fall's radio shows and the first showings of the new 1925 styles in radio sets and parts will be at San Francisco in August. With radio shows to be held in every large city it is necessary that any one show have several distinctive features in order to attract the nationwide attention already attained by the San Francisco show. This is to be one of the largest and most representative expositions of radio equipment yet held, occupying the entire main hall of the Civic Auditorium. All the exhibit space has been taken two months before the doors are to be opened to the public. No promoter is to take a profit, as it is to be co-operatively conducted at cost by the Pacific Radio Trade Association. Many unusual and spectacular exhibits are to be staged. All these features insure a show that should not be missed. More complete details will appear in August RADIO.

# Locating Ship Positions by Sound and Radio

By S. R. Winters

*This new method of position determination obviates the use of a radio compass. The several special devices required and their method of operation are fully described. It has proved practical for distances up to 30 miles.*

THE use of a bomb-created sound in conjunction with a radio signal in making known the position of a ship with respect to pre-determined shore stations, is a radical departure from any of the existing systems of locating vessels. A method developed co-operatively by the Bureau of Standards and the Coast and Geodetic Survey, and subjected to practical tests on the coast of the Pacific ocean, enables a vessel engaged in making depth soundings or otherwise charting the sea to determine its position on the map, at any moment, despite fog or other adverse weather conditions.

The difference in the speed of sound waves and electro-magnetic waves is taken advantage of in this newly evolved method of determining the position of a ship. The latter, traveling at a rate of 186,300 miles a second, may be said to reach their destination at the moment that they are created. The velocity of sound in sea water is about 1,600 yards per second. Radio-sound ranging involves the transmission of a sound from an explosive and the sending of a radio signal at the instant that a sound wave reaches its destination. The distance from the source of the sound is measured by noting the time elapsed between the creation of the sound wave and the instant the radio return signal arrives at the sound source.

Obviously, shore stations are necessary in this system of radio-acoustic ranging, as well as specially designed apparatus on shipboard. The observing points on land—in this instance three in number—require hydrophones, sensitive instruments for detecting sound through water. These, under-water microphones, are submerged 60 feet, just off shore, with a cable leading to the stations on land. A TNT bomb, a war-salvaged explosive, is fired from a vessel which desires to determine its position in fog or low visibility weather. This bomb-created sound wave upon reaching each hydrophone, automatically releases a radio signal which is recorded on board the vessel as the time of arrival of the sound at the shore station.

The distance of the vessel as well as its position from shore is then a matter of mathematical calculation. If each shore station transmits a single radio signal, there will be only three time intervals on the sheet of the chronograph. Each of these time intervals is multiplied by the velocity of sound—1600 yards a second in water—to indicate the distance of the vessel from the corresponding hydrophone. In the use of radio-

acoustic ranging, the locations of the three hydrophones are pre-determined and their positions plotted on a map. According to geometrical calculations, each position of the hydrophone is theoretically accepted as a center from

clockwork of the automatic key has started to function.

The performance at the three shore stations is a duplicate of that on shipboard, with the exception that the code wheels are adjusted to send radio signals

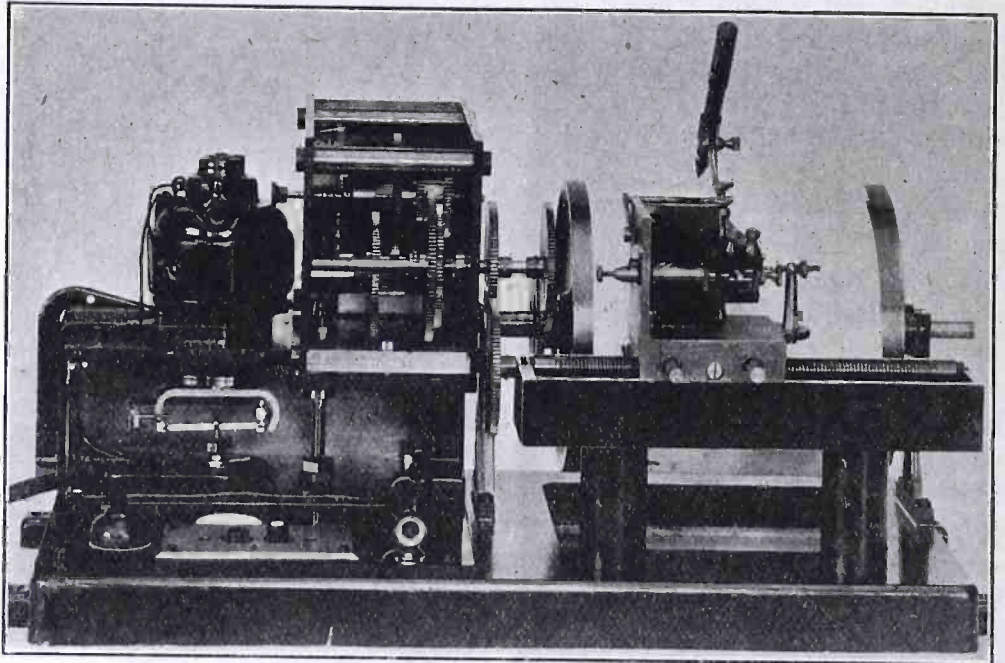

Fig. 1. Ship Unit for Radio-Sound Position Determination

which an arc is drawn with the corresponding distance as radius. The latter intersect at the location of the vessel. In fact, three arcs do not intersect in a point but their coming together will form a small triangle. If each arc is to be measured on its theoretical basis, the geometric center of this triangle will afford the information sought, namely, the position of the ship at the moment that the explosion of TNT started the sound signal.

The bomb is fired with a snap switch, which performs a threefold duty. It explodes the TNT, records the moment of the closing of the firing circuit, and controls the sending of a radio signal. The latter is heard at three shore stations, giving assurance that the bomb has been exploded. This sound, upon reaching the hydrophones, is translated into an electrical impulse, and by means of radio-amplifying equipment, is amplified to the extent that it will actuate a relay. The latter causes a clock work to function which rotates a code wheel. This, in turn, operates a second relay at specified intervals from the start. The second relay operates the radio transmitting equipment by means of which signals are sent at intervals determined by the code wheel. The first signal on any of these wheels occurs not less than five seconds after the clockwork has been put in motion. This affords opportunity for switching on the transmitter after the

at different intervals between each other and with variations at the start. The radio signals originating from the three shore stations are intercepted by the antenna on the ship and by means of radio instruments they are recorded on the chronograph drum which records the signal indicating the moment of the explosion of the charge of TNT. These signals are identified with respect to the stations from which they emanated by their difference in spacings, and the time intervals between the discharge of the bomb and the arrival of each signal from a specified station.

The data sought with respect to the location of a ship from known shore stations may also be completed by finding out the lag. This is done without discharging a bomb. In the determination of the lag, the radio signal at the shore station is caused to actuate the relay which previously was operated by the sound signal. The automatic keys at the three shore stations are started at the same time. The records on the chronograph of the vessel, therefore, give the time from the sending of the wireless signal to the reception of each signal from the station located on land. These intervals, once measured, afford information relative to lags. In determining a lag, the operator at a shore station is bound to switch from "receive" to "transmit" positions after the automatic key has started and before the initial

signal of the code is transmitted thereby. This minimum time element is of about five seconds' duration.

The equipment necessary for charting the ocean by means of a combination of radio and sound is shown in Fig. 1. The units are seven in number, including a radio receiver, amplifier and relay, chronometer and relay, chronograph and pen magnet, radio transmitter, triple pole firing and marking switch and safety switches. The radio receiving unit is Westinghouse R. C. type, employing a detector and two stages of amplification. WD-12 vacuum tubes are used, the filaments of these being lighted by dry-cell batteries.

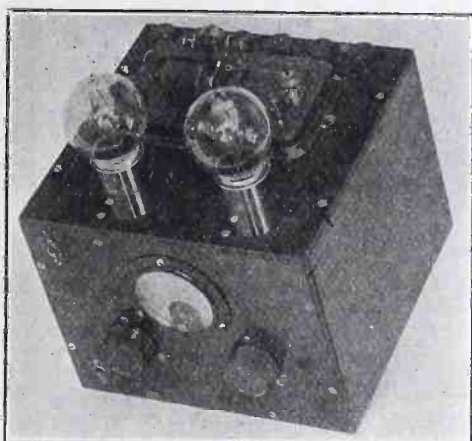

Fig. 2. Amplifier and Relay in Ship Unit

The amplifier and relay, designed and built at the Bureau of Standards, is a two-stage, low frequency, transformer-coupled unit. It resembles the amplifiers used at shore stations except that it confines its performance to the recording of radio signals. As seen in Fig. 2 the panel meter indicates the amount of current passing through the relay windings; the rheostats regulate the filament current of the vacuum tubes; and the jack is for plugging to the radio receiver. The top panel, as illustrated, shows the sockets for the electron tubes, relay, and binding posts for batteries.

The chronometer and relay employed in this method of radio-acoustic ranging is of a standard design, affording a signal every second. A break-circuit mechanism interrupts the electric current through an auxiliary relay, the purpose of which is to translate the "break circuit" into a "make circuit." This relay has a resistance of 75 ohms. By using two dry-cell batteries the electric current thus available is about 40 milliamperes, which is all that can be imposed upon the break-circuit mechanism of a chronometer. Friction is little, owing to the fact that the armature of the relay is equipped with hardened steel pivots which function in jewel screw bearings.

The chronograph recorder is an invention of Dr. E. A. Eckhardt of the Sound Laboratory of the Bureau of Standards. In designing this instrument, allowance had to be made for the rolling and pitching of a ship. The hanging weights which were adequate in

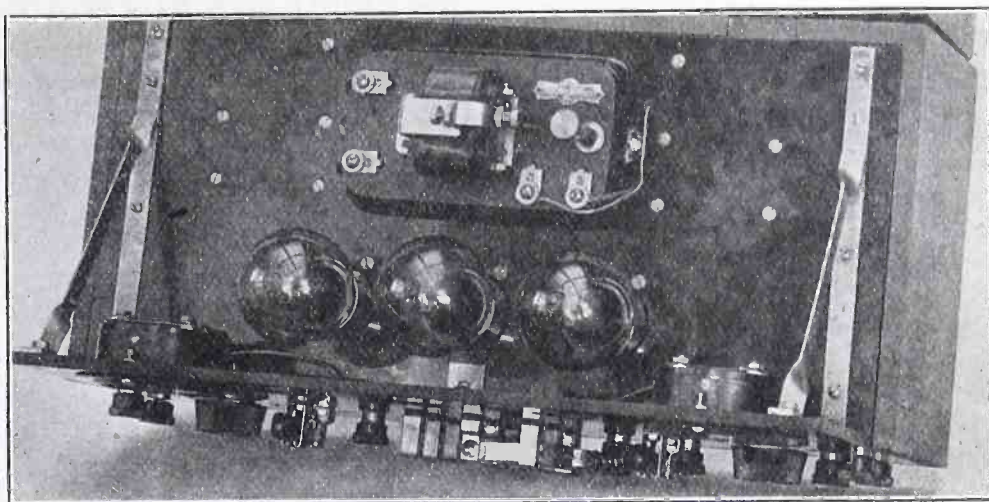

Fig. 3. Power Amplifier and Relay in Shore Unit

supplying motive power when used on land as an automatic radio recorder had to be discarded in this instance. Instead of these weights a 1/20 h.p. motor is used both for motive power and in controlling the speed of this chronograph. This motor, similar to a commercial design, is of the series type, operating on 110-volt direct current. Its manner of controlling the speed of the chronograph is by means of a contact which opens and closes a short circuit across a resistance in series with the motor. If the motor speeds up greater than desired, the centrifugal action of a weight raises a lever and a contact opens, thus inserting a resistance into the circuit. This reduces the speed until this contact closes.

The pen magnet is similar to that used in the recorder designed by the Bureau of Standards for automatically copying radio-telegraph signals. Each spool contains two separate coils, each consisting of a like number of turns. The inside coil of one spool is connected to the outside coil of the other spool, thus constituting two electrical circuits. This manner of construction makes for an equal resistance in the two electric circuits. A common battery is employed, which insures an equality of electric current in the two circuits, and therefore, the ampere turns, which determines the tug of the magnet on the armature,

should be equal. The windings, on the other hand, are connected differentially in order that the armature will be attracted when only one of the circuits is closed. Moreover, the armature is released when both are either open or closed. One of these electric circuits is actuated by the recording relay and the bomb-firing switch, and the other by the chronometer relay. Thus the purpose of the latter is established. The pen magnet circuit is operated by a "make" contact instead of a "break," and furthermore, greater current is necessary for operation than should be imposed upon the chronometer contacts.

The radio transmitter used is a standard design of the United States Navy Department for use on aircraft, known as type SE-1370.

The equipment used at shore stations includes the following units: Hydrophones, power amplifier and relays, radio receivers, automatic keys and relays, transmitters, and power supply.

The power amplifier is designed to increase the energy charge produced by sound or radio signal to a point adequate to the operation of an electromagnetic relay. This amplifier has three stages and is coupled by means of transformers, relay coils being inserted in the plate circuit of the last stage of amplification. A departure from amplifying units used for reception of broadcast programs is

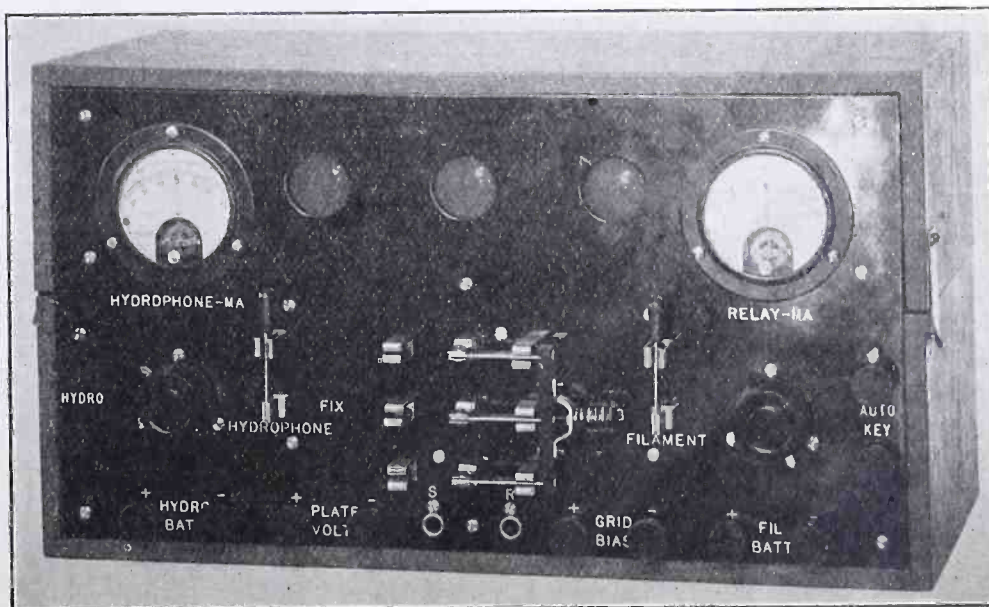

Fig. 4. Hydrophone Unit

that of having the grid of the last vacuum tube negatively biased to the point that no current is flowing in the relay circuit. The interception of a radio signal increases the current from virtually nothing to a value high enough to actuate a relay. A change-over switch enables the operator to throw the primary circuit of the input transformer either into the hydrophone hook-up or the output circuit of the radio receiving apparatus.

This amplifier, which was designed for service afield, is of a rugged nature with respect to its protective features against unfavorable weather conditions, and yet the interior of the outfit is readily available in case of repairs being needed. There are a multiplicity of binding posts, these being necessary for batteries, hydrophones, automatic keys, circuit switches and rheostats for controlling hydrophone and tube filament circuits, triple-pole change-over switch for throwing in either the hydrophone or radio circuit, meters for indicating the electric current in the hydrophone and relay circuits, and the telephone jacks.

A radio receiver, a duplicate of the one previously described as used on ships in this radio-acoustic ranging, an automatic key which is a clockwork mechanism driven by a spring and provided with a relay stop and start device; a standard naval aircraft transmitter; and a supply of eight trays of batteries, are the other units used in the shore-station equipment. Then, too, there are units for charging the storage batteries. These consist of two different types—one an air-cooled generating unit of an output of 600 watts at 32 volts, and a 4-horsepower water-cooled charger rated at 1,250 watts.

Credit for having devised this radio-acoustic ranging system and the apparatus used in its practical application is jointly shared by Dr. E. A. Eckhardt of the Bureau of Standards; Commander W. E. Parker and Commander N. H. Heck of the Coast and Geodetic Survey; Colonel R. S. Abernethy and Major H. C. Allen of the War Department. After tests covering a period of twelve months on the Pacific Coast, its feasibility of determining positions of ships up to 30 miles has been determined.

### EXPERIMENTS WITH SHORT WAVE TRANSMISSION

**T**HE development of short wave radio transmission, which has resulted in the rebroadcasting of signals from WGY by eight English stations, has produced some interesting phenomena. As high as ten kilowatts have been impressed on the antenna at Schenectady in starting the 107 meter pulsations on their long journey and, because of this great power, special precautions must be taken by those who handle it.

For months experiments have been carried on by a group of General Electric radio engineers in a small isolated building, a mile from the transmitter of WGY. In this building has been assembled, in the apparent disorder of most laboratories, the equipment necessary for a high-powered radio transmitter. The station, because of the power and variety of wavelengths used, operates on the experimental license 2XI.

Because of the intense field about the transmitter it is possible to light an ordinary sixty watt lamp to full brilliancy by holding the lamp in the hand. Two men, standing on insulated stools, and each holding a metal rod in his hand, can draw a six inch arc between the rods. No shock is felt because cur-

rent of this nature travels through the skin rather than through the body. However, if bare hands were used instead of the metal rods, a severe burn would be the result. The building is heated by a small coal stove and the

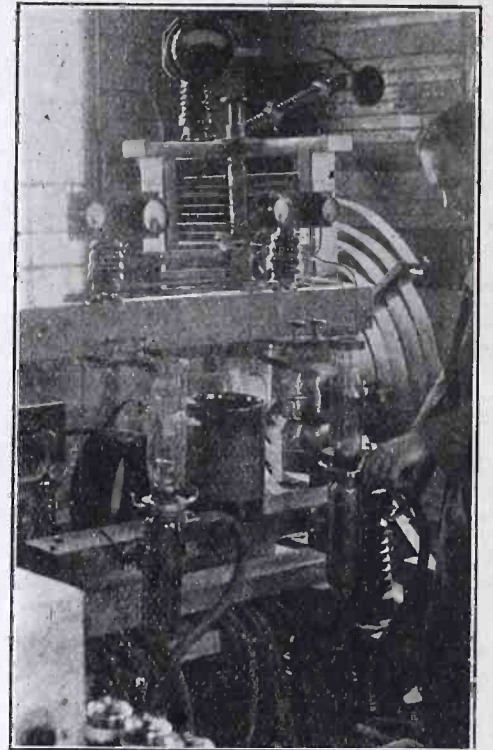

*Water Cooled Oscillator and Modulator Tubes*

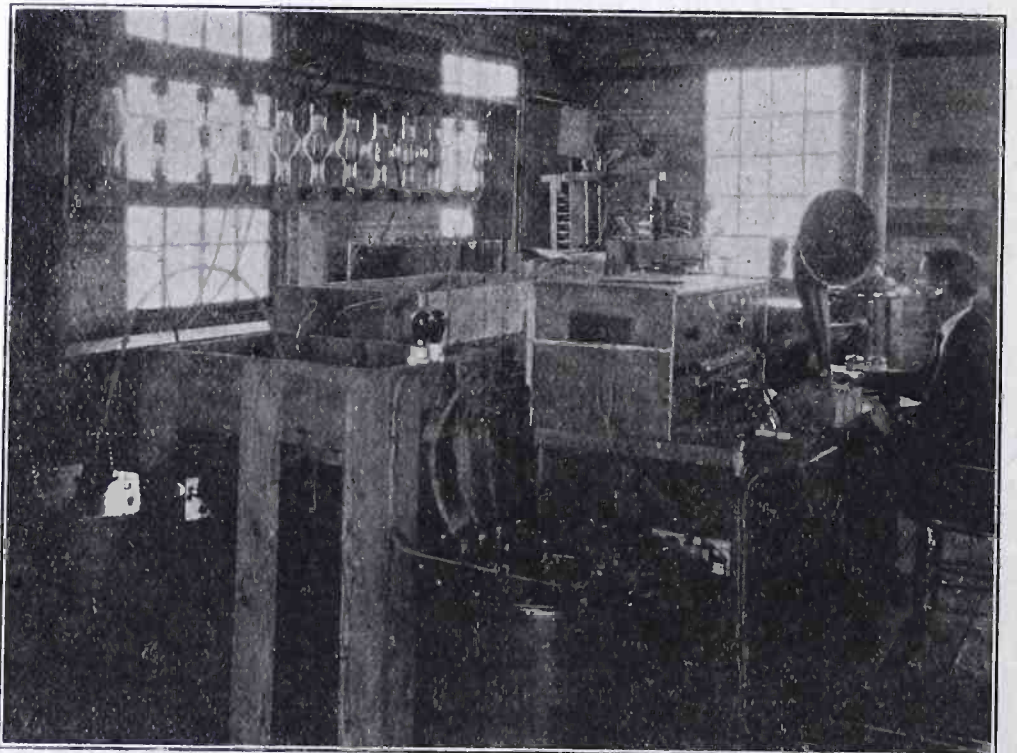

*30-K.W. Plate Current Supply from 12 Tubes in Short Wave Experimental Laboratory*

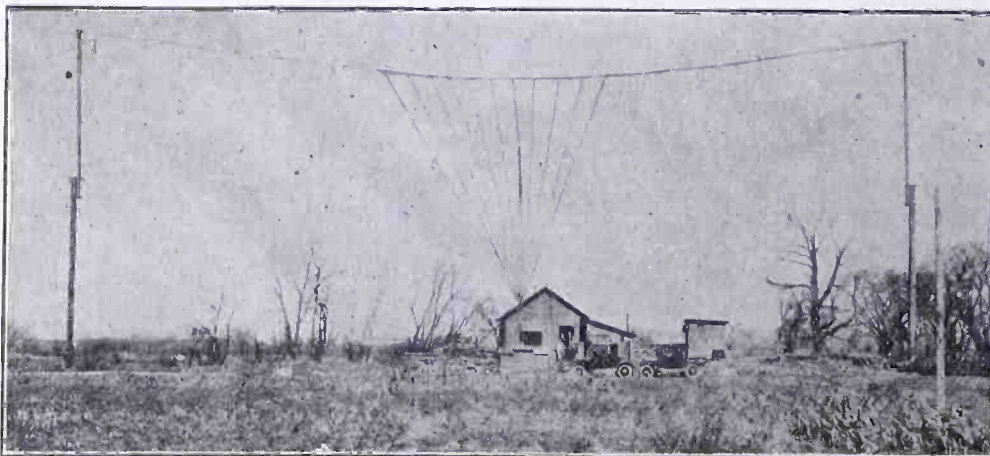

*Fan-Shaped Transmitting Antenna Used in Short Wave Experiments*

engineers have learned that care must be taken in transferring coal from the coal bucket to the stove. If the body comes in contact with any metallic object arcs will jump from stove to shovel. Metal pencils, watches or similar articles containing metal cannot be carried on the person on account of the small sparks which will jump to them. Shoes with nails cannot be worn because of the sting experienced when the wearer steps on nails in the floor.

By the use of its short wave transmitter WGY has reached distant places

*Continued on page 50*

# The Reception of Radio Waves

By C. M. Jansky, Jr.

*After a concise statement as to how radio energy is received, Prof. Jansky tells how it is detected and converted into sound. He describes the functions of both crystal and vacuum tube detectors, showing several detector circuits.*

THE power radiated from a radio telephone or telegraph transmitting station is disseminated in all directions over the earth's surface. The amount of energy in a particular wave front decreases as the wave reaches points farther and farther away from the transmitting station. A certain amount of this decrease in energy content can be calculated from well known laws, but other factors enter in which cause great variations in the strength of received signals at any particular point. These variations in signal strength depend upon many factors such as the wavelength or frequency in use, the time of day, time of year, atmospheric conditions, topography of territory between transmitting and receiving stations, etc. The fact that small and moderate-powered stations are sometimes heard over great distances on certain nights is due to the absence of absorption which is so pronounced in the daytime. It is this great variation in received signal strength coupled with the great variation in strength of interfering noises such as "static" which limits the reliable range of radio-transmitting stations to distances but a fractional part of the range sometimes obtained under favorable conditions.

Whereas the power radiated from a radio telephone transmitting station may be from 5 to 5000 watts, the power received at a receiving station two or three hundred miles away is of the order of magnitude of a few millionths of a watt. This power is in the form of electromagnetic waves of such wavelength that the human senses are not capable of perceiving or detecting them. (Electro-magnetic waves of short wavelengths between 4 ten millionths and 8 ten millionths of a meter can be detected by the human eye directly and cause the sensation of light). At the receiving station an open antenna or coil is used to collect a portion of the energy present in the wave radiated by the distant transmitting stations. The wave sets up minute high-frequency currents which are identical in character with those present in the antenna of the transmitting station. The open or coil antenna is usually, but not always, tuned to the radio-frequency produced by the incoming wave.

The high-frequency currents produced in the receiving set by a radio telephone transmitter must be converted to sound. This conversion to sound involved a process called "detection" or "rectification," after which the detected

current is passed through a telephone headset. The rectified current, in passing through the headset, should cause the diaphragms to vibrate to correspond to the sound waves received by the microphone at the transmitting station. The electrical energy in the receiving set may be amplified either before detection or afterwards, or both. Amplification of radio-frequency currents just as they are received by the antenna is called radio-frequency amplification. Amplification of the rectified currents is called audio-frequency amplification. Sometimes the incoming frequency is reduced to a frequency still above the audible range and this frequency is amplified before detection. This is called intermediate frequency amplification and such receiving circuits are often called super-heterodyne circuits.

The process by which the minute amount of power in the human voice (a few millionths of a watt) can be converted to electrical power, amplified until of sufficient intensity to control the output of a machine radiating from 5 to 5000 watts, which modulated power is transmitted over many miles to points where it is received by thousands of receiving sets, amplified and converted back to speech which can be clearly understood, is a very marvelous one. It appears all the more marvelous when one considers how clear and faithful a reproduction of the speaker's voice can be obtained and when one fully realizes the many possibilities for distortion in both transmitting and receiving circuits. Clearly, the development of radio telephony is one of the highest triumphs of science. Like most great scientific achievements, the credit should not go to any one man, but to the many untiring workers whose accomplishments have done so much to make the world a better place to live in.

## Crystal Detector Circuits

THE simplest and least expensive receiving sets use crystal detectors. Fig. 26 is the circuit of a very simple crystal receiving set. Let us assume the received radio wave sets up a current, the graph of which is shown in *A* of Fig. 27. This is identical with the current graph discussed in the June article (Fig. 24).

The antenna circuit is tuned by the series coil. (A good combination for nearby broadcasting stations is an antenna 30 to 50 ft. high and 50 to 75 ft. long with a coil of 40 to 60 turns of

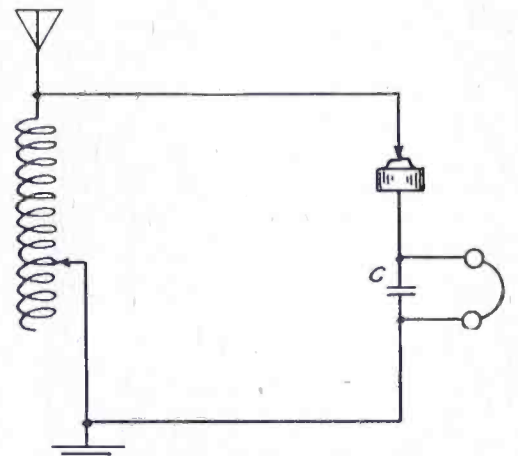

Fig. 26. Simple Crystal Receiving Set

No. 20 or larger double cotton-covered wire on a 4-in. tube. The coil should be tapped about every three turns, beginning at the twentieth turn.)

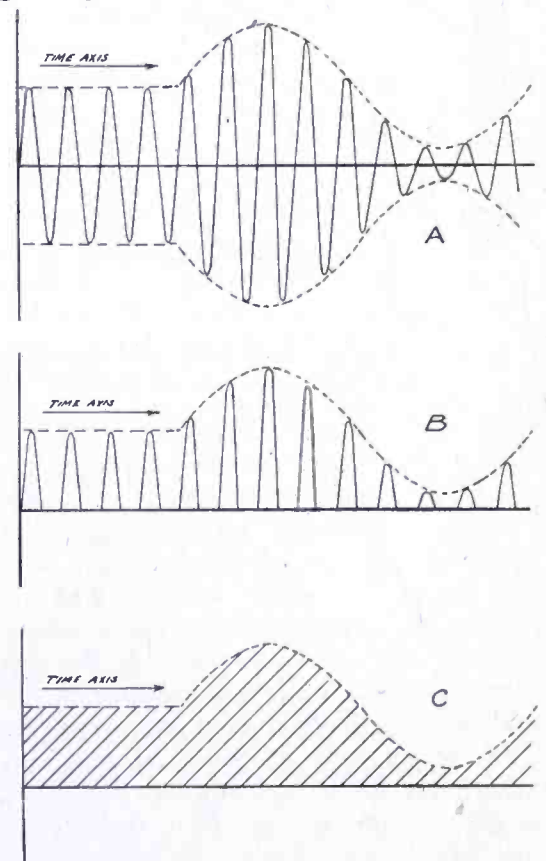

Fig. 27. Process of Crystal Rectification  
*A. Sine Modulated Radio Frequency*  
*B. Rectified Current Through Crystal Detector*  
*C. Current Component Through 'Phones*

The crystal detector is a device consisting of one of many minerals which may be used for this purpose mounted solidly with a sharp pointed wire resting on it. One connection is made to the pointed wire and the other to the crystal. This device for some unknown reason possesses the peculiar property of passing current more easily in one direction than the other.

The condenser *C* (Fig. 26) across the headset should be large enough so as to offer little reactance to the radio-

frequency currents (about 1000 microfarads). The radio-frequency voltage across  $L$  is therefore impressed across the crystal. Because of the uni-lateral conductivity of the crystal one half of the current curve is cut off as is shown in  $B$  of Fig. 27. The radio-frequency portion of this rectified current passes through the by-pass condenser  $C$ . There is left, however, a component as shown in  $C$  of Fig. 27 which corresponds to the modulating frequency which is determined by what is spoken into the microphone at the transmitting station. The pull of the electromagnet in the headset and consequently the deflection of the diaphragm will, therefore, also correspond to what is spoken into the microphone.

Crystal receivers for radio telephone reception are limited in range to about 25 or 50 miles, although good results may be obtained up to 100 miles at times and, under very favorable conditions,

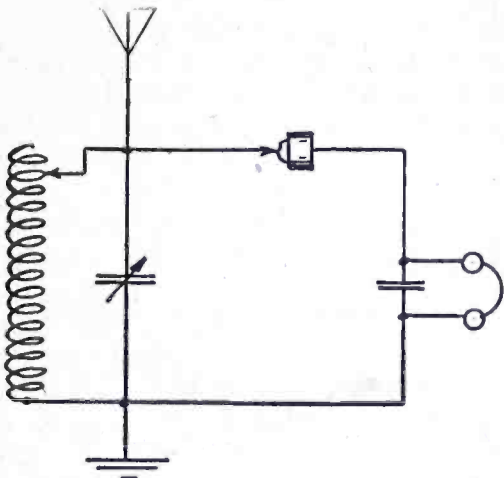

Fig. 28. Crystal Connection for Average Antenna or For Long Waves

over much greater distances. They are comparatively inexpensive and give remarkably clear reproduction. An advantage well worth bearing in mind is the fact that no batteries of any sort are required. This feature was of greater importance before the development of the dry cell tube. A twenty-three plate-variable condenser can be used to advantage in a crystal receiver. For receiving long waves or with an average or small antenna the condenser should be in parallel with the tuning coil (Fig. 28). For large antennas or for short wave stations the condenser

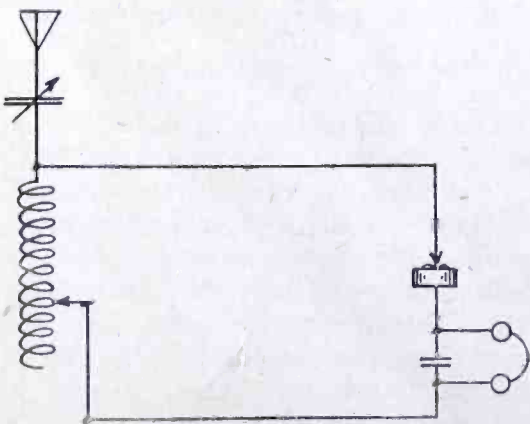

Fig. 29. Crystal Connection for Long Antenna or For Short Waves

should be in series with the antenna as shown in Fig. 29. The inductance may also be variable if desired, in which case a fixed condenser may be used in the tuned circuit.

Many people do not realize that where two or more nearby high-powered stations operate simultaneously selectivity can be obtained by using a coupled circuit receiving set as shown in Fig. 30.

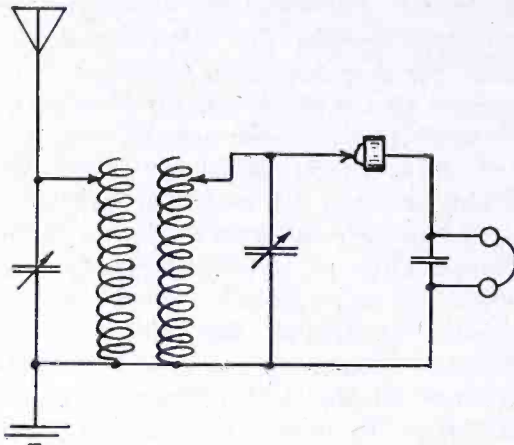

Fig. 30. Coupled Circuit Crystal Receiver

A point to be borne in mind in the design of all crystal circuits is the fact that high resistance in antenna or circuit will materially affect signal strength. A moderately short, high antenna is best for the same reason. This type will also give greater selectivity than a long, low one.

### The Three-Electrode Vacuum Tube

WE have now reached a point in our discussions where we must study a device which has done more for the science of radio communication than all others put together. This is the three element electron tube, vacuum tube, audion, pliotron, valve or triode, as it is variously called. These various names have been given to the device by the many men who have worked to bring it to perfection. The uses to which vacuum tubes may be put in radio communication are many. One tube may be used to generate the high frequency currents which are radiated into an antenna at a radio phone transmitting station. Another may be used to modulate that radiated energy. Still others may be used to amplify the voice currents produced in the microphone circuit. At the receiving station a series of tubes may be used to amplify the radio frequency energy collected by the antenna. Another tube may be used to detect this energy, while still others may be used to amplify the voice currents after they have been received. One can easily see that modern radio telephony would not be possible without this most versatile of all radio instruments, the three electrode vacuum tube.

It is of particular interest to note that a discussion of the action of vacuum tubes carries us back to the fundamental discussion of the nature of electricity as taken up in the first lecture of this series in May RADIO.

A device consisting of a glass bulb from which all air has been exhausted containing a tungsten filament which may be heated by an electric current and a plate of much larger area near the filament is called a two element vacuum tube. (Fig. 31.) The tungsten filament of this tube contains atoms which

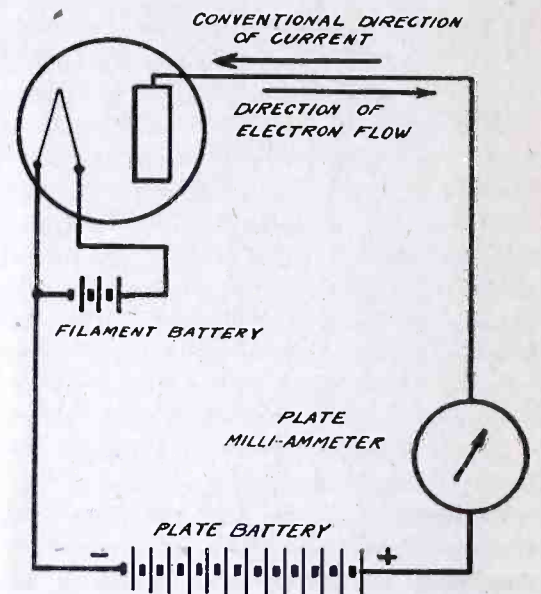

Fig. 31. Two-Element Electron Tube

consist of positive nuclei surrounded by electrons. The atoms and electrons which go to make up this filament are in constant vibratory motion which manifests itself as heat. If we pass a current through the filament by the aid of a battery the motion of these atoms and electrons will increase until finally, as the filament becomes almost white hot, some of the electrons are actually boiled off into space. Thus we have the hot filament surrounded by a cloud or swarm of electrons, which are *negative* particles of electricity.

If a positive potential is applied to the plate in the glass bulb by means of a plate battery some of the electrons are attracted to it. We thus have a stream of electrons passing from filament to plate through plate battery and back to the filament. Wherever we have a flow of electrons we have an electric current and therefore the stream of electrons which we have described is an electric current. By convention we think of the currents as flowing from filament through battery to plate and thence from plate to filament. Actually we know that the electrons travel in the opposite direction. It is unfortunate that the convention governing the direction of current was adopted before we actually knew what an electric current is, with the result that our convention is misleading. It is of special interest to note that in the electron tube we are concerned with the passage of electricity through a perfect vacuum. If the battery shown in Fig. 31 is reversed and the plate made negative with respect to the filament no electrons will pass from filament to plate as the negative plate repels the electrons which are also nega-

Continued on page 62



# What Music the Radio Public Wants

By Arthur S. Garbett

*This is an intelligent analysis and skillful interpretation of the facts upon which is founded public appreciation of music. It is filled with information of intense interest and value to the broadcast listener.*

"ONLY think!" said the ecstatic lady who was president of the local music club: "A broadcasting manager in Los Angeles made a canvas of his 'listeners-in' and found that forty per cent of them want only good music—*really good*. Forty per cent!"

The writer surveyed her gloomily, wondering whether to disillusion her or not. Having had some years' experience in the phonograph business at one of the flood-gates of popular music in America, he knew all about that forty per cent. They are known to irreverent salesgirls and hard-boiled men in "the trade" as "music nuts." Granting that such a canvas was made, and that the facts were as stated, the people who responded were only dimly representative of "what the public wants." These replies came from people who are definitely interested in music, jazz or otherwise, and not from the real mass of listeners-in who take whatever comes without noticing what it is, without caring, and certainly without bothering to send postcards about it to anybody.

If percentages mean anything—which they don't—a better canvas could have been made by consulting, say, a dozen representative dealers in phonograph-records and player-rolls, and finding out what the public actually *buys*. Yet, even this, would only be partly reliable, for some dealers are "music nuts" themselves and push the "red-seal stuff" while others prefer jazz, which sells itself; and once more we would be dealing with people who care definitely about music—be it jazz or grand opera.

Millions of people in this large country don't own musical instruments of any kind and never will. Many of these are, or will become, radio-fans—and for other reasons than music. They are the dead-weight; the mass, who listen-in, taking what they get, apparently indifferent so long as they get "a kick" out of whatever comes in from the air. The common herd! The dull, unthinking, unimaginative, indifferent—

Call them all the names you want, but they are people. They have rights. What's more, they have likes and dislikes which are nonetheless pronounced because they may be unexpressed. Radio-music is universal music; it must suit *everybody*. How, then, are we to ascertain "What the public wants" on an all-comprehensive basis?

The writer has stayed awake nights thinking that over. It was his business problem for years; and since he chose to interpret his "job" on educational, ideal-

istic lines as the result of a long technical musical training and has a marked personal preference for Bach, Beethoven and Brahms; since he was further encouraged to do so by the best "boss" a man ever had; and since he was given facilities for finding the answer by studying the facts at first hand, questioning everybody in sight, musical or not, educated or not—highbrows, lowbrows, pipe-fitters, office-stenogs, school-music supervisors, singers, violinists, vaudevillians, composers, salesmen—perhaps he may be permitted to state his conclusion. The more so because the answer is on the whole encouraging. And, furthermore, since the answer can be boiled down to a single sentence, it may as well go in italics:

*All people want SOME good music SOME of the time; and only a few want good music ALL the time.*

And as a corollary to that: When they are momentarily enthused by music that has "gotten under their skins" they are liable to write postal cards about it—whatever it was, jazz or symphony. Otherwise not.

But just when is music "good?"

Don't go to the musician for the answer to that—especially not the enthusiastic amateur who has no wide experience in public entertainment upon which to draw. His very enthusiasm will blind him. He forgets that an unmusical person may yet be a good druggist or plumber and therefore a good citizen whose preference for wailing

Hawaiians must be considered. Don't go to the zealous musical educator; "good" music to him is whatever is "good" for the Young Person. He confuses ethics with aesthetics too readily. Go to the psychologist-philosopher who has an intimate knowledge of the working of the human mind and body, and a cool, unimpassioned judgment of music and how it reacts upon the human organism.

His answer will be, when all the facts are considered, something like this: "Music, in common with all the arts, must serve a utilitarian purpose as well as an aesthetic one; it must be useful as well as lovely so that soldiers can march to it, people can dance to it, and poets can rhapsodize over it. It must serve the physical, mental and emotional needs of the mass of people as well as the few." In a word, any music is "good" so long as it serves the purpose for which it was intended: jazz for the jazzy, symphonies for the symphony-minded. The radio-public must be served with all kinds of music except that which, by degrading associations, is of degrading moral tone.

This last reference to morals will bear a little explanation. Music and morals have been the subject of debate for centuries, but, on the whole, the curious fact remains that music has no morals of its own, but can heighten the moral effect of its associations, for good or ill. The same tune may work either way. One of Beethoven's most inspired melodies is also the tune of "How Dry

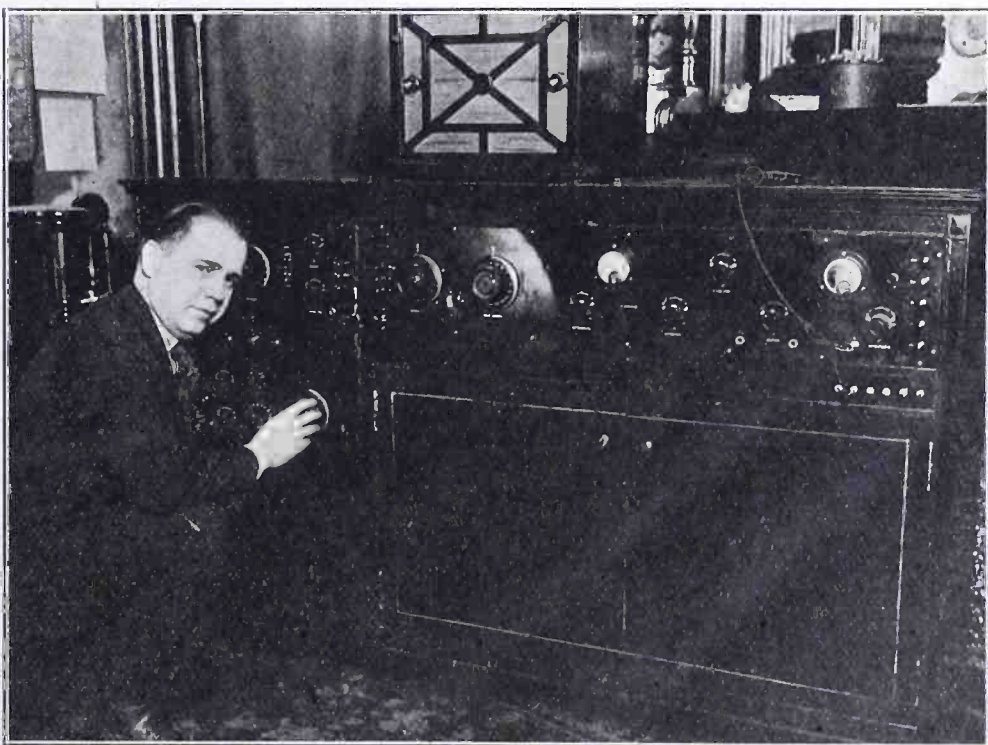

*Giant Super-Heterodyne Built by F. R. Greene of New York City. It uses either 8, 9, 11 or 14 tubes, has 19 dials, and the cabinet is 5½ ft. long, 3½ ft. high and 16 in. deep.*

—Wide World Photo.

I Am." In this association, of course, it is not particularly edifying; yet in the concert room it is truly a great melody.

Nor, by the way, is this the only contrast which that Beethoven melody offers. Mendelssohn borrowed it complete and put it into his "Duetto" (one of the songs without words). He also used it less recognizably in other compositions, each time with a different effect aesthetically and, therefore, emotionally, morally. But that isn't all, for that same Beethoven melody has recently been dished up again, and is—by all that's marvellous—the "Merry Widow" waltz. Whistle "How dry I am nobody knows"—just that far; and follow that up with the "Merry Widow" waltz, and you'll see!

This instance is interesting, but not incredible to musicians, for, in music, highbrows and lowbrows are always borrowing from each other. Folk songs often appear in symphonies; fine tunes are often degraded. The song "For He's a Jolly Good Fellow" was once, it is said, a Crusader's hymn, and later a lampoon on the Duke of Marlborough ("Malbrouck s'en va-t'en guerre"). Medieval composers frequently drew upon popular songs, often ribald folk songs, to use as a "ground-base," a sort of central core about which to weave their many-stranded counterpoint for the Holy Mass. Our national anthem, "The Star-Spangled Banner," was originally an English drinking song called "To Anacreon in Heaven."

Music and morals aside, however, we are still facing the question, "What does the radio public want in music?"

Speaking from known and tested facts, the writer is prepared to say that the mass-public wants three kinds of music: Popular dance music or jazz, ballads or "story-songs," and a broad miscellany of music known to the music-publishing, player-roll and phonograph-record, and popular-concert giving world (over which Sousa and Victor Herbert reign) as the Popular Classics.

Those who have followed this series of articles so far will begin at last to see the light. In our first article it was shown that music consists of two things: sound and rhythm; and for the sound we have ears, while for the rhythm we have a motor-sense (a dance-impulse). This is putting music on a strictly "motor-sensory" basis as the psychologists would say. From this aspect, jazz is ideal. It tickles the ear and tickles the feet; and in both it serves a fundamental human need which dates from prehistoric times. It tickles our ears by grotesque harmonies, and "queer" instrumentation, such as saxophones, banjos, "stopped" trumpets, and occasionally a few kitchen utensils. All this for the ear very much what those little "telescopes" filled with colored glass were for the eye in our childhood days. In

addition, jazz has a strong, crude rhythmic pulse for the feet: an unvarying tom-tom beat at bottom above which are superimposed highly syncopated effects known as "ragtime." This is excellent for dancing, especially popular dancing. The mass of people cannot bother to learn complicated dance-steps. The tango, maxixe, etc., went out, charming as they were, because they simply would not fit the needs of a public which includes fat men, clumsy men with fallen arches, women built on dreadnaught lines, as well as lissome flappers and the boy who sat as a model for the collar "ads."

In a word: people dance because they must. Their dance music must tickle their ears as well as their feet. Jazz does both, and in a peculiarly native, American way. Broadcasters, take notice!

Our second article went further. We went past the ear-tickling, foot-tickling stage, and tried to show, however lamely and superficially, the marvellous things that happen when music gets past the outer doors of the senses and reaches the brain. Here an amazing "inductance" is set up in the form of "Associated Ideas," so that our memory, imagination, emotion are reached, often with astounding and thrilling results. Music can thus mingle with our hopes and dreams in the most astonishing and providential way. Our very lives can be changed by a single song heard at the precise "psychological moment." Nay, more, the destiny of nations.

In the year 1702, an officer of engineers in the garrison at Strassburg leapt upon a table at a crowded tavern and sang a song he had composed that thrilled his hearers, filling them with a furious energy. The song was "The Marseillaise" and the singer was Rouget de Lisle. The whole French nation took up the chorus and marched to its strains upon Paris. They tore down the Bastille, flung the king from his throne, slaughtered and destroyed their oppressors to its mad music until the tumbrels rolled to the guillotine through streets of blood-stained mud. The whole world shook to that tune. Though radio was unknown, echoes of it swept far across the Atlantic and a new republic was intoxicated by it. Washington's troops knew that song. LaFayette's men must have roared it about the campfires at night!

Few songs shake whole peoples in that manner. Fewer still are technically as good in melody, harmony, rhythm and poetry as that stupendous Marseillaise. This song, however, is of itself one of a well known and clearly defined type of song which is universal: it is a "ballad." A ballad is a story-song, one that tells a tale or expresses a sentiment, not necessarily patriotic. Like dance music, the ballad is prehistoric. By means of it the bards of old celebrated their warrior-

leaders, and mothers in cave-dwellings soothed their children. Homer drew upon such legendary ballads for his two great epics, the Iliad and the Odyssey.

In the ballad, the words are usually more important than the music, which is usually extremely simple, and—unlike the dance—devoid of strong rhythmic accent, so that the singer may hang upon the words without destroying the "swing" of the melody too much. Often both words and music, though very simple, are extremely beautiful and touching, as with such old favorites as "Silver Threads" and "My Old Kentucky Home," and the like. Often again—oftener in fact—both words and music are trivial and insignificant. What the highbrows call "trash," yet capable of powerfully affecting their untutored listeners.

Not longer ago than war-days, an American troopship went down in the North Atlantic one cold, winter night. And the doughboys went down into the sullen grey waters singing as they went. They sang "Where Do We Go From Here?"

Bad music? Silly words? Who will dare say so? Will anybody even dare say they are inappropriate? No hymn tune or highbrow melody would have expressed the sheer Americanism of those boys as that song did! Even the old British "Contemptibles" of 1914 with their mournfully ironic "Tipperary" didn't beat that!

Let us be wary of tampering with "vulgar" ballads; let us be wary of refusing them to unthinking masses of radio fans; such crude strains have kindled strange fires in human breasts, even though usually they pass over us harmlessly, leaving no effect save a moment of rather mawkish sentimentality to which we may or may not respond favorably.

The public, then, has a right to jazz, and plenty of it. The public has a right to ballad songs that are clean, however crude. We have said, however, that "all people like *some* good music *some* of the time," and that brings us to the popular classics, so-called.

Just why certain melodies or concerted pieces of undoubtedly "classic" origin leap into favor while others, equally good, do not is a mystery. Usually, however, there are fairly clear specific reasons in individual cases: Handel's "Largo," with its broad, massive, dignified harmonies, fills the ear if it does nothing else. Mendelssohn's "Spring Song," with its lightness and delicacy of rhythm, lives up to its suggestive title. There are three, very different melodies alike by virtue of certain long drawn-out notes peculiarly adapted to the sonorous qualities of the violin G-string, which have been greatly popularized by master-violinists, though two of them are songs: Schubert's "Ave

*Continued on page 52*

# A Three-Tube Reflex Receiver

By Paul Oard

*Complete directions are here given for building a three-tube reflex receiver well adapted to broadcast reception on a loop or short indoor aerial. The three tubes associated with a crystal detector give three stages of radio and two stages of audio-frequency amplification.*

THE reflex circuit, although by no means new, is essentially a circuit better suited to reception of broadcasting, rather than to amateur or commercial wave bands. It offers a maximum of amplification with a minimum number of tubes, combining as it does both radio and audio amplification, with detection taken care of by a crystal detector. Although another tube may be substituted to take the place of the crystal, the increased difficulty in manipulating the circuit generally offsets the advantages gained to the majority of those experimenting with this circuit.

Most of the technical articles treating in a popular vein on the reflex circuit, and particularly those dealing directly with the construction of instruments embodying this circuit, have centralized on the single-tube circuit, which gives in effect one stage of radio-frequency and one stage of audio-frequency amplification. The two-tube reflex circuit has received some attention at the hands of the experimenter, but the three-tube reflex, while it has intrigued considerable interest, has as yet but few who have familiarized themselves with its construction and operation.

The three-tube reflex receiver is not difficult to build, and, properly constructed, is not a difficult circuit to handle. It is a particularly sensitive instrument when used on very small inside antennas or loops. It is extremely sharp in tuning, and will work through local broadcasting stations to distant points without difficulty.

It is not advised that a novice attempt the construction of this receiver, until he has first built up and operated the single-tube reflex, or has had some actual building and wiring practice in the construction of the radio-frequency and regenerative circuits that are in standard use among radio enthusiasts. This ad-

vice is given for two reasons—first, unless the builder has had actual experience in operating standard circuits, he will not be able to make accurate or fair comparisons against such circuits, and much of the benefit otherwise gained through construction and operation of the three-tube reflex will be lost.

The second, and an important reason, is that the units used in the instrument herein described have been so placed as to occupy a minimum of space in their relation to each other. For this reason,

expect to take longer. The time required will be found to be worth it, however.

As generally the constructor will draw on his supply of units already on hand, rather than buying up an entire set of new units, and as these units in many cases will have already been used in other experimental instruments, particular attention should be paid to their electrical condition. Transformers, condensers and sockets should be gone over carefully. If soldered connections

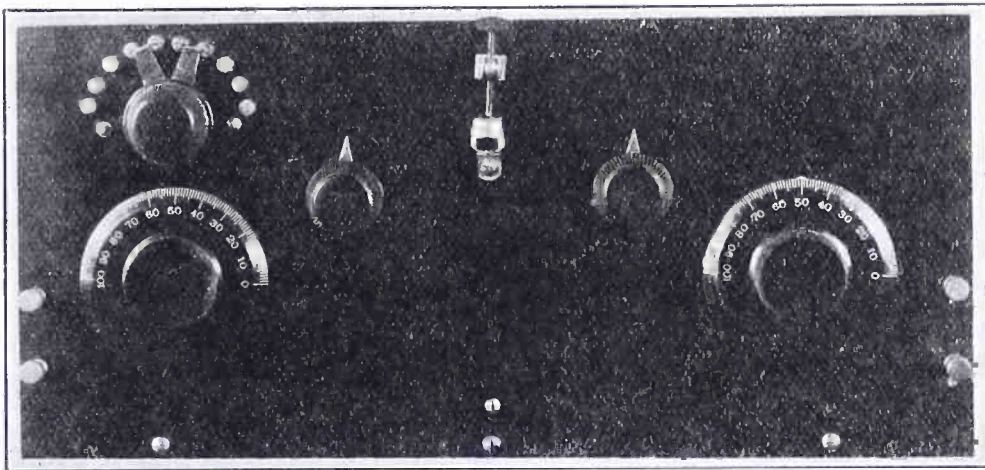

*View of Completed Panel for Three-Tube Reflex*

busbar wiring, following conventional custom, with all bends turned square, is the only practical method of wiring, and due to the multiplicity of bends and crossings, only one who has some previous experience in such form of wiring should attempt the job. Taking it for granted, however, that the constructor has some such experience, there need be no fear of the outcome of the job. Only one thing should be borne in mind—don't rush. An experienced wireman, constructing this instrument for the first time, will require under normal working conditions about six hours to do the job right. This is for the wiring alone. The inexperienced constructor should

have been used, all solder should be removed with the iron, and the terminals of the various units should be most carefully gone over with a rag to remove any possible trace of soldering acid or flux, unless the solder has been fluxed with rosin. In spite of the fact that many of the fluxes on the market are supposed to be nonconductive (and are, as far as ordinary electrical needs are concerned), in construction of this sort, it is imperative that every vestige of flux be removed. Particularly should transformers in which the terminal posts are insulated from the metal frame by means of fibre washers, be inspected, even to the point of disassembling them for cleaning. Flux oftentimes flows, under the heat of the iron, over the fibre washers and up against the metal frame, resulting in a possible minute short circuit. Careful attention to the cleaning up of such terminals will do much toward the elimination of so-called parasitic noise.

Socket springs should be bent well upwards, and cleaned at the point of contact with a fine nail file or fine emery paper. The lamp terminals should likewise be brightened, but care should be taken not to remove the solder from the pins, or connections inside the base will be loosened. All windings should be

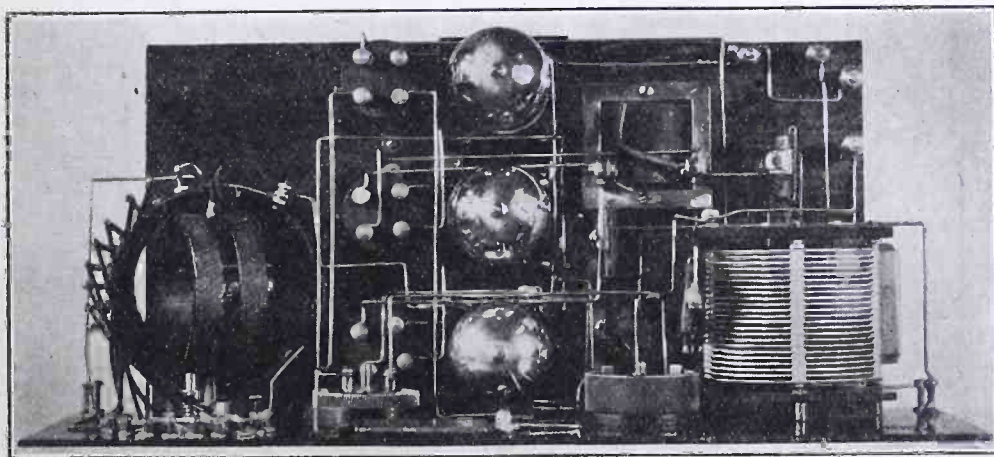

*Top View of Three-Tube Reflex*

tested with the headset and battery to insure closed circuits, transformer frames should be tested against the terminals to insure against such a circuit, and primary and secondary windings should be tested against each other to insure likewise. All fixed condensers should be tested against short circuit. Likewise the variable condenser. It is no fun to wire up this circuit and then, finding it inoperative, have to remove a unit in order to correct a fault. Better insurance against trouble is to follow out the above procedure, even though it does take time. This particular instrument is well worth building right.

with an 11-plate variable, signal strength will be increased considerably, but as this is essentially a broadcast receiver, such procedure is not generally warranted, and therefore no provision is made for putting this condenser on the panel.

In the switch point assembly, the last two taps being "riding taps" for the two blade switch, only eight points are wired to the primary of the vario-coupler. As the primary tunes fairly broad, the constructor may vary from this number if found necessary. It will not be found necessary to shield this receiver, body capacity even on small antenna being practi-

rheostat, potentiometer and variable condenser have been placed at a standard point; however, such mounting holes may be varied in relation to this position to the shafts to accommodate holes already made in such units.

The sockets should be so placed that the grid and plate terminals face the radio-frequency transformers, on the left-hand side of center of panel. This will bring the *A* battery terminals on the right-hand side of center of panel. Short leads are thus assured to plate and grid terminals of the radio-frequency transformers.

In wiring assembled units, after they have been carefully mounted, the connections to *A* battery terminals and to rheostat and socket terminals should be made first. Next wire in the grid and plate connections to the radio-frequency transformers. The leads to the remaining units will overlap these, and therefore will come last. In the original instrument it was not found necessary to use spaghetti on any of the leads, but some constructors may find this necessary, with the exception of the leads from the vario-coupler to the switch points. Soldering should be avoided wherever it is possible to make connections by means of binding posts, and all flux should be most scrupulously wiped up. Rosin core solder is of course the best to use, but not all constructors can handle this to best advantage. After bending a wire to position, it should be tinned with solder first, as should the terminal to which it is to run; all surplus flux is easily removed in this way. The two terminals then being brought together, a touch of the iron will join them.

It is a good plan, after the constructor has completed and carefully checked over the wiring, to call in a brother experimenter and have him also check it.

A sensitive piece of tested silicon is recommended as the mineral to be used in the crystal detector. It is stable, and standing as it does a good contact, it will not jar out easily. Good silicon is as a rule sensitive at all spots of the crystal.

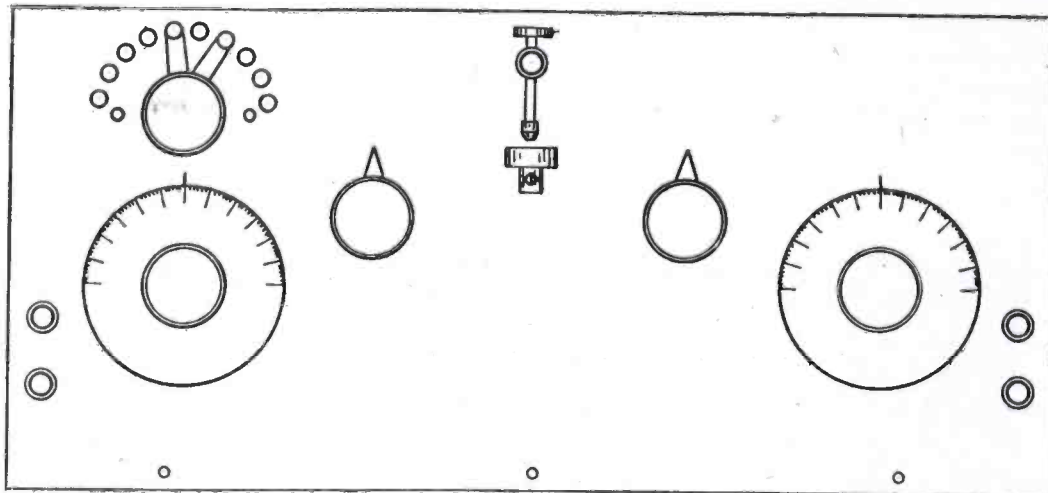

Panel Plan

The following parts and units will be required to construct this three-tube reflex:

- 1 Panel, 7x15x1/8.
- 1 Baseboard, wood, 7x13x1/2.
- 10 Switch Points.
- 2 Switch Stops.
- 1 Double Blade Switch Knob Assembly.
- 2 Bakelite Dials, 3-inch.
- 1 Potentiometer, 200-400 ohm.
- 1 6-ohm Rheostat.
- 1 Ball and Socket Crystal Detector Assembly.
- 8 Binding Posts.
- 3 Wood Screws, Oval Head, 1-inch.
- 1 3Gang Socket Assembly, or 3 Sockets.
- 1 43-Plate Variable Condenser.
- 5 .002 M F Fixed Condensers.
- 1 .005 M F Fixed Condenser.
- 2 Audio-Frequency Transformers.
- 3 Radio-Frequency or Reflex Transformers.
- 1 Vario Coupler.
- Busbar, Spaghetti, Mounting Screws.

In accordance with the writer's general caution in regard to reflex circuits, use only closed circuit transformers on the radio-frequency side—transformers in which the secondary circuit is closed, not open.

The 43-plate variable may be replaced by one of 23-plate capacity in the event that the secondary of the vario-coupler is wound with a fairly high ratio of turns. If, in using a 23-plate condenser, the constructor is unable to tune to 600 meter spark stations, then the 43-plate condenser should be used. This receiver, as constructed, tunes in such spark stations, though the writer does not find it fully efficient at such wavelength. However, by shunting the primary of the first reflex transformer

cally zero. The utmost care must be taken in seeing that all controls run smoothly, otherwise jarring of the detector on critical points of adjustment will induce noises that will prove unwelcome.

It is assumed that, as only one rheostat is used to control the tubes, that the three tubes will be of the same characteristics. WD-11, 199, UV-201A are all equally efficient, if three of a kind are used.

The baseboard, 13 in. in length, will just accommodate the units mounted on it. If the vario-coupler is large this baseboard may be increased an inch in length so as to cover the base, although this will not be necessary, as the coupler is mounted in most instances from the panel. The mounting holes for coupler,

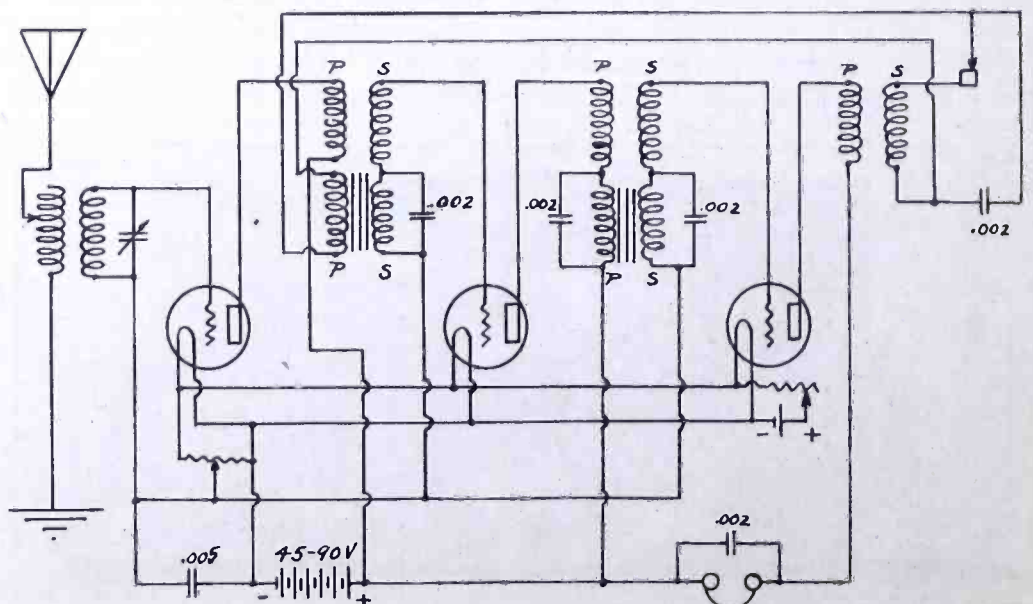

Circuit Diagram for Three-Tube Reflex

AS in other reflex circuits, it is best that the constructor become familiar with its operation on an outside antenna, of usual length. A good ground connection, regardless of the length of the antenna, is essential. Choose a time that the local broadcasting station is on, for the first test. Set the primary variation switch at about the center of the coil winding. Turn the rheostat so that the lamps burn close to maximum brilliancy. Next vary the coupling and the secondary variable condenser until the wanted station is picked up. With the crystal out of adjustment, the instrument will show a tendency to "pluck up;" adjusting the crystal will result in a boiling noise in the headset. While this reflex circuit will naturally howl at certain adjustments, especially when the detector is not correctly adjusted, it is not a bad offender in this respect. Most of the howling will be found to be of a low frequency, and is not as hard on the ears as if the pitch were of higher character. The potentiometer, holding the grids at potentials between negative and positive, will also be a large factor in correct manipulation. During the first test, it should be alternately set on the extreme positive and extreme negative positions. The tendency of the instrument to tune broad or sharp will be influenced largely by the position of the secondary coil in relation to its coupling to the primary. It will be found possible to tune in as many as four or five stations in one grand muddle, with a certain setting, regardless of the secondary condenser; a change in coupling will render tuning then dependent entirely upon the secondary condenser, and it will be extremely sharp. Practice makes perfect in the handling of this instrument, and one should not get impatient if results are not as expected at the first.

Now, as to results that may be expected. The writer uses two antennas, one a compromise single-wire type, 75 ft. long, and 60 ft. high at the far end, tapering to the instrument connection. The other, inside the instrument room,

is a single wire 20 ft. long, and is 8 ft. above the surface of the earth. With the inside antenna, results are practically identical as are obtained on the outside one. This with the outside antenna either grounded or ungrounded. Incidentally, static is just as strong as on the outside type. Operated from Stockton, California, at the beginning of the "radio season" (October), practically all stations within a thousand-mile radius are picked up with ample strength for the loud speaker. All distant stations, outside of the 360-meter wave band, can be picked up through the local broadcasting station, which puts out three amperes of well modulated current.

In citing results on the inside antenna, the writer makes allowance for a possible "siphoning" from overhead power and light wires. The instrument has not as yet been tested in open country on small antenna or loop. KFI and KHJ at Los Angeles, some 350 miles airline distance, and Calgary, Canada, around 700 miles, are picked up with sufficient volume with both antenna connections grounded, to be heard over the entire house on loud speaker. Tuning in this instance is critical, and there is some slight capacity effect. Placing the hand on the antenna post will strengthen signals to a point comparable to those obtained on the regular antenna. There

is probably a coupling effect obtained between the input and output circuits in this instance, through the head receivers. A five-plate variable shunted between these two points offers some interesting possibilities in remote station reception without the antenna.

Signal strength from the local stations is not in proportion to that of outside stations, nor does the use of antenna make a whit of increase in signal strength, though it does broaden the tuning. The instrument is not freakish in performance, if one checks carefully all control positions for future reference, although if this is not done the novice may form such an opinion in operating at separate times on a given station. Due to the fact that the circuit operates at the point of saturation on strong signals, and functions comparatively stronger on weak signals therefore, a wide latitude for control of fading or swinging signals is experienced, and this circuit is not affected as are many other circuits.

In this circuit signals are amplified at three stages of radio-frequency before being rectified by the crystal detector and are then amplified at two stages of audio-frequency after rectification. Obviously, therefore, it will function proportionately stronger on outside stations.

A cabinet for the completed instrument is optional with the constructor. As part of the value of the reflex lies in its use as a portable type, the cabinet, if built, should make allowance for all batteries, and the dry cell types should be used in tubes. The fact that howling is not extreme makes it possible to use a headset without danger to one's feelings in case the detector is jarred off adjustment at a critical control.

Inasmuch as a fair outlay of apparatus is called for in this receiver and as the wiring job is one that takes time if done right, the constructor should take all due pains to do the right job. The writer considers this reflex circuit, which is credited to De Forest, as a worthwhile type, and bearing in mind the cautions set forth as one that will amply repay for the labor and expense put forth in its construction.

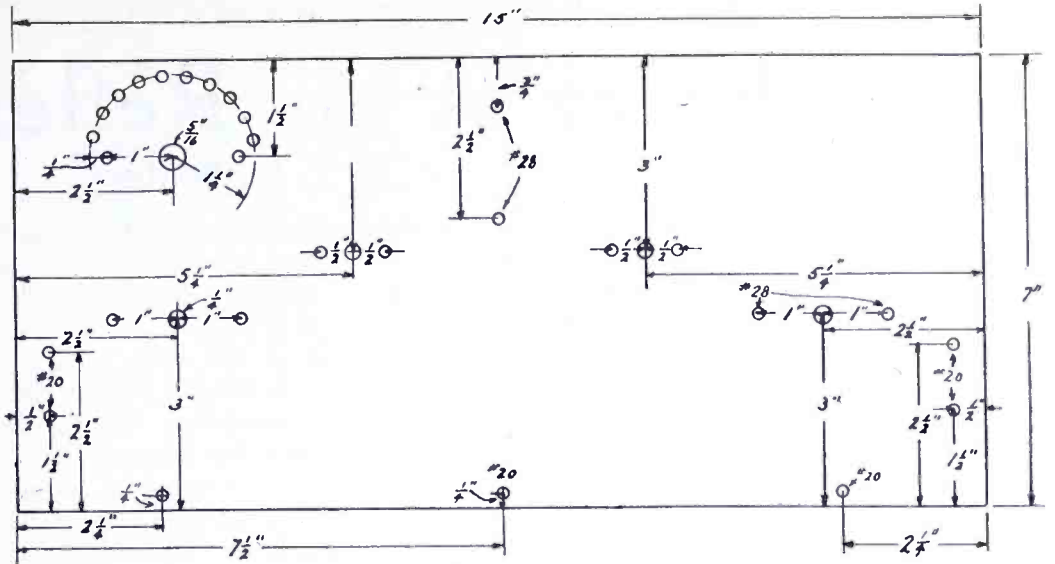

Panel Layout

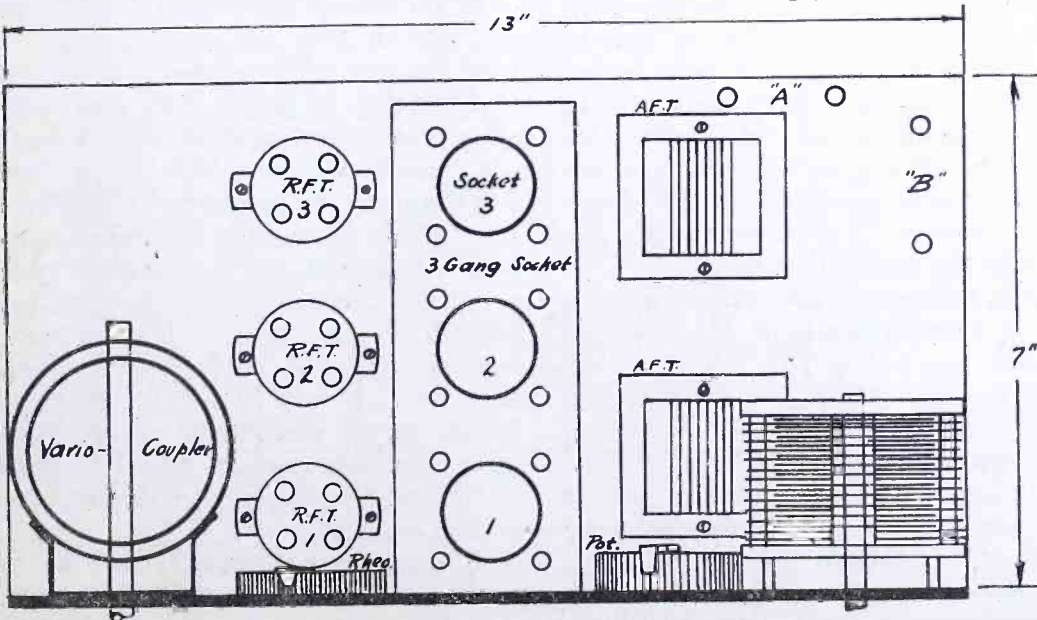

Baseboard Plan, Showing Panel Mounting of Vario-Coupler, Potentiometer and Variable Condenser

# Theory of the Reflex Circuit

By L. R. Felder

*In simple terms herein are described the fundamental principles, the advantages and the disadvantages of the reflex circuit. This information is essential to anyone interested in the construction or operation of a receiver of this character.*

THE last of the really original and important circuits which we have to consider is the reflex circuit, of which there are fifty-seven varieties with fancy names. The idea of the reflex circuit originated with a French engineer of international prominence, Marius Latour, who is, therefore, entitled to whatever credit is given for the circuit. It is true that his circuit was more fully developed by Americans, but the original idea was his. A great many unnecessary frills and furbelows have been added to this circuit by self-styled radio experts, and as a result we have "plex" and "fref" circuits which are nothing more, generally, than the original reflex circuit in disguise.

The big idea underlying the reflex circuit, and which gives it its chief virtue, is *tube economy*. The importance of tube economy is, of course, well appreciated by all radio fans. Modern receivers are tending more and more towards the use of radio-frequency amplification before the detector. As a result, if separate tubes are used for radio-frequency, detector and audio-frequency, the number of tubes in the set begins to get excessive. Five, six, seven and eight-tube sets are not at all unusual. Since each tube costs \$5.00, the initial cost of the set and tube renewals are great. Not only this, but battery wear and expense mounts, for six tubes use up twice as much filament current as three, and also drain the *B* battery twice as fast. Hence, if some means could be provided for making four tubes, say, do the work of six an immediate four-fold saving would ensue: (1) initial cost of set, (2) smaller number of tube renewals, (3) *A* battery power saving, and (4) *B* battery power saving. Such an arrangement involves incidental savings such as fewer tube sockets, rheostats, etc., and simplifies operation if we consider each tube filament has a separate rheostat to be controlled.

The reflex circuit is the first big step in this direction. Its main reason for existence is its economy. The engineering idea underlying the reflex circuit is the simultaneous use of a single tube for both audio and radio-frequency amplification. This is possible to the extent that any given tube is able to amplify at both radio and audio-frequencies. The efficiency of reflexing is therefore proportional to its amplifying properties at radio and audio-frequencies. If the tube amplifies poorly at radio-frequencies and very well at audio-frequencies the reflex action will be inefficient. The same

statement holds if the tube is a poor audio-frequency amplifier but a good radio-frequency amplifier. Good reflexing is made possible by virtue of the fact that the standard tubes as made in America are both good radio and audio-frequency amplifiers. Thus the UV-201A and C-301A are uniformly good on both r.f. and a.f.

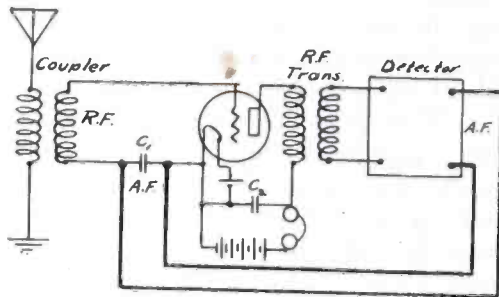

Fig. 1. Diagram Illustrating Reflex Principle

Fig. 1 illustrates the action of the reflex circuit. Here is represented a single tube with a detector of some sort. The radio-frequency from the antenna is impressed on the grid of the tube through the medium of the coupler. The r.f. transformer in the plate circuit amplifies this signal, which is then impressed on the detector. The output of the detector is an audio-frequency signal (marked *A.F.*) which is carried back to the grid of the tube as shown. An audio-frequency voltage is thus impressed on the first tube which amplifies the audio signal. The telephones or loud speaker are in the plate circuit of the first tube. Thus the tube has impressed on its grid a radio-frequency signal and an audio-frequency signal, and in its plate circuit appear both an amplified radio signal and audio signal, from Fig. 1, and this explanation the reader will be able to appreciate the statement as to the efficiency of reflex action. For it will be seen that if the tube is a poor audio-frequency amplifier there will not be much advantage or gain in reflexing, for the audio signal after reflexing may not be much louder than it is in the output of the detector. In order to fully understand the action of reflex circuits and the precautions to observe, it will be best to consider some of the standard circuits.

There are two types of detectors which may be used in reflex circuits, a non-amplifying detector such as the crystal, and an amplifying detector such as the vacuum tube. Both may be used satisfactorily, though the crystal gives more stable operation. Fig. 2 illustrates a simple one-tube reflex set employing a crystal detector.

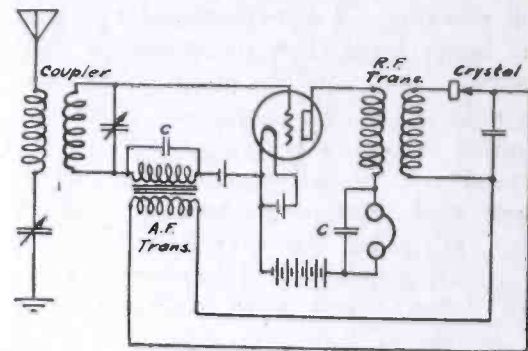

Fig. 2. Simple One-Tube Reflex Circuit

The action is identical with that described in the previous paragraph. It will be observed that a condenser *C* shunts the secondary of the *A.F.* transformer, the telephones and the primary of the *A.F.* transformer. These condensers are necessary for the efficient performance of the set and are essential on all reflex sets. They serve the purpose of by-passing the radio-frequency currents efficiently.

Thus consider the secondary of the *A.F.* transformer. If no condenser were used across the secondary the r.f. currents in the grid circuit would have to flow through the secondary of the a.f. transformer. This, as is well known, would introduce so much loss and voltage drop that very little r.f. voltage would ultimately reach the grid and low signal intensity would result. To avoid this, a condenser is shunted around the transformer secondary which efficiently by-passes the r.f.

For the same reason the telephones or loud speaker must be shunted with a condenser. For the amplified r.f. currents in the plate circuit of the tube will flow through them unless so shunted, and, consequently, introduce further losses.

In the case of the crystal detector and primary of the *A.F.* transformer we have the case of a detector which is not perfect, that is, which does not rectify all of the radio-frequency. As a result, the radio-frequency which is not rectified must be by-passed by a condenser *C*. These by-passing condensers must have a relatively low reactance to radio-frequency currents, but at the same time must have an extremely high reactance to audio-frequency currents. For, unless they do, they will by-pass or shunt the higher speech frequencies which would otherwise flow through the *A.F.* transformer or telephones. In this way distortion is produced.

These two requirements for the by-passing condensers, namely low reactance to radio-frequency currents and high reactance to speech frequency currents, are

not incompatible. A small condenser has a low reactance to radio-frequency currents, but has a high reactance to audio-frequency currents. Suitable values for *C* are values between .0005 microfarads and .002 microfarads.

It will be observed in Fig. 2 that a *C* battery is employed. This is strictly necessary if good quality of speech and music is to be had. The value of the bias depends upon the plate voltage, but for voltage up to 90 volts a good value for bias potential is 3 to 4½ volts negative on all standard tubes such as the UV-201A, C-301A, UV-199 and so on. For the crystal detector it is recommended that a fixed contact crystal be used. Good ones are now available and are advertised in the various periodicals. They avoid the trouble of having to fuss with the contact. In place of the crystal detector a tube detector may be used.

Fig. 2 illustrates how, with one tube, r.f. and a.f. amplification may be secured. With a one-tube set of this description loud speaker operation may be had if not too far from the transmitter. It will readily be seen that the reflex set lends itself to portability more than any other, since, by reflexing, the number of tubes may be reduced to almost half that required by a straight set for any given results. This, taken together with the fact that present-day tubes may be used with dry cells, makes the reflex set ideal for the portable receiver.

Fig. 3 represents a two-tube reflex receiver which is ideal for portability. The two tubes are used for both radio-frequency and audio-frequency amplification. Such a circuit will give very good loud speaker results, and may even be used with a loop antenna. The two tubes perform the same duties that four tubes do in the ordinary set, namely there are two radio-frequency stages and two audio-frequency stages.

The circuit of Fig. 3 is what is called a straight reflex circuit, that is, the radio-frequency progresses from the first tube to the last, and then the audio-frequency likewise progresses from the first

tube to the last. This system of reflexing is subject to a number of disadvantages. The system is subject to instability—especially when a tube detector is used—oscillations being easily set up. For, if any r.f. passes through the detector, it is fed back to the first r.f. tube and progressively amplified. This feedback and progressive amplification may cause oscillations. Secondly this system of straight reflexing causes overloading very easily. This is easily shown in Fig. 3. The last tube carries very large radio-frequency currents and very large audio-frequency currents, in brief, carries twice the load which a normal amplifier tube carries. Where three tubes are used the last amplifier tube carries still more power. The first tube carries little power. The last tube may, therefore, be overloaded to the point where distortion occurs.

A modification of the reflex circuit has therefore been developed which eliminates the above disadvantages. This modification is called the "Inverse" system and is due to Mr. D. Grimes. In the inverse system the radio-frequency progresses from the first to the last tube, but the audio-frequency progresses in the opposite direction, namely from the last to the first tube. The net result is that overloading is avoided, each tube carries approximately the same amount of power, and instability causing oscillations

is avoided. How this is accomplished is shown in Fig. 4.

In Fig. 4 is shown an inverse reflex set employing two tubes and a crystal detector. The radio-frequency input progresses from the first tube to the detector in the usual manner. The audio-frequency output of the detector is now fed backward in the direction from the second tube to the first, that is, the second tube, which is the second radio-frequency tube, is the first audio-frequency tube. The a.f. output of this tube is then fed into the first tube. Thus the first tube, which is the first r.f. amplifier tube, is the second a.f. stage which operates the loud speaker. As a result, it will be observed that each tube is equally loaded; if one tube carries small r.f. currents it also carries large a.f. currents, while if it carries small a.f. currents it will also carry large r.f. currents. Thus the load is equally balanced in all tubes. Secondly no tube is overloaded or worked too hard, for it never carries the full r.f. and a.f. load at the same time, as happens in the straight reflex system. Thus overloading and distortion are avoided. Finally instability is decreased owing to the fact that progressive amplification of any r.f. which gets through the detector is eliminated. For, if any r.f. does get through the detector capacitively, it is applied first to the last r.f. tube and can, therefore, be amplified only by this tube, whereas in the straight reflex it is amplified by the first and second tubes. For these reasons the inverse system has proved itself the best where a number of tubes are used, say three or more. Obviously where only one tube is used the inverse system is not applicable. For two tubes it is. Whether there is any advantage in the two-tube inverse reflex depends to a considerable extent on the capabilities of the tubes. Thus for UV-199 tubes the inverse system is preferable, for these tubes are easily overloaded. On the other hand, the UV-201A is capable of handling considerable power and to that extent that the straight system may be employed, provided the system is built so that there is not much capacity feed-back.

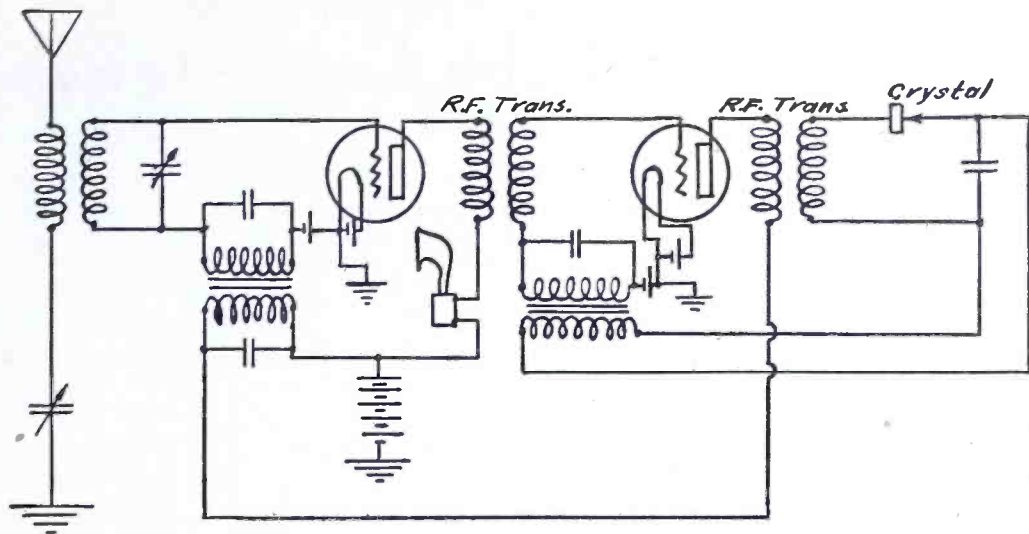

Fig. 4. Grimes Inverse Reflex Circuit

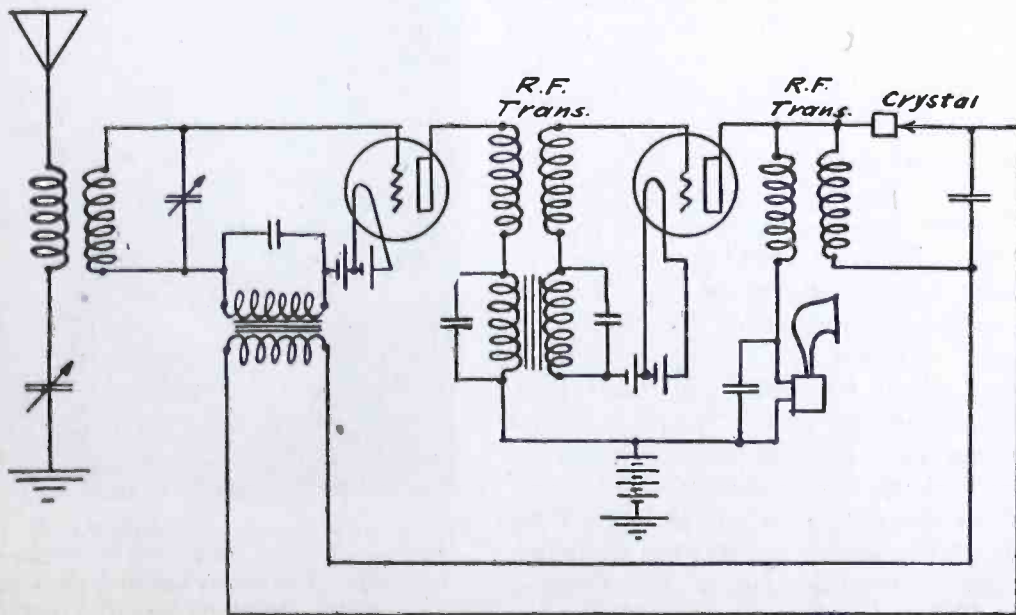

Fig. 3. Two-Tube Reflex Receiver

# Effect of Tube Capacitance and Resistance

By Walter Emmett

*This is an analysis of the unbalancing effect that comes from introducing a vacuum tube into a circuit whose various inductance and capacitance relations are known. It should be of considerable help in the design of an efficient receiver.*

THE effect of tube capacity and resistance is frequently overlooked in designing a radio circuit. The grid-plate capacitance of the vacuum tube in the tuned-plate tuned-grid circuit of Fig. 1, for instance, is equivalent to a condenser  $C_5$  coupling the resonant grid circuit with the resonant plate circuit.

One of the reasons why an audio-frequency transformer in place of the variometer  $L_2$  does not show appreciable effects on the tuning frequency is the high equivalent resistance which it introduces into the plate and thence into the grid circuit. The secondary has about 600,000 ohms and such a resistance

effective value of the tuning capacitance,  $C_2$ , is at least doubled.

The tuning frequency of the grid circuit now depends as much on  $C_4$  as it does on  $C_2$ , and, to make matters worse,  $C_4$  is variable to a large extent. It adds from 20 to 200 micro-mfd. near the resonance point. This change is less when resistance is present in the inductance  $L_2$ . This resonance effect is secured by tuning the plate inductance  $L_2$  for greatest response. If  $L_2$  is not tuned  $C_4$  will be less, but still greater than if a pure resistance or capacitance replaced  $L_2$ .

It is evident that the action of the tube in introducing  $C_4$  "bucks" the action of the designer who makes  $C_2$  as small as possible. The smaller he makes  $C_2$  the larger does the tube make  $C_4$ . Remember this is at small values of  $C_2$  and wiring capacitance, of from 40 to 160 micro-mfds. There is a final complication which  $C_4$  introduces, which does not seem to have been noted to any great extent and that is the fact that it has a different effect according to the point where  $L_2$  is tuned.

If  $L_2$  is tuned at the small dial readings of  $C_1$  at a short received wave, and left in position, the tuning range of the apparatus is decreased and the regeneration is decreased at the longer waves when  $C_2$  is tuned for them. If on the other hand  $L_2$  is tuned for the longer waves, the tuning range of  $C_2$  is increased and the regeneration is therefore also increased.

These increases of regeneration are liable to produce oscillations which are O.K. for "zero-beat" reception but bad for "spark signals," since they "mush" them.

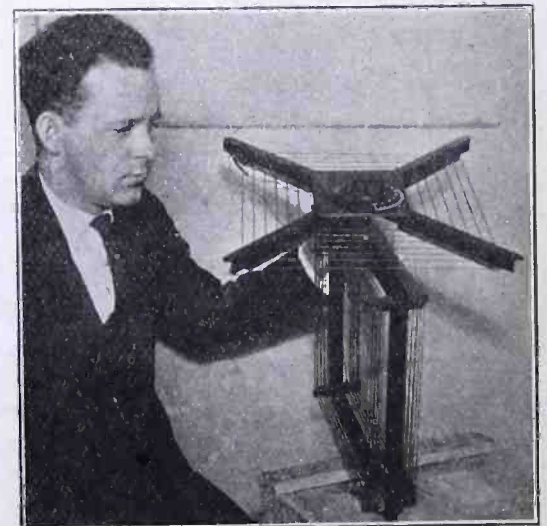

*Vertical-Horizontal Loop Devised by Harry Herzog of New York City to Improve Selectivity. Tuning is accomplished by the dial, which moves the vertical loop to the right or left.*

—International News Reel Photo

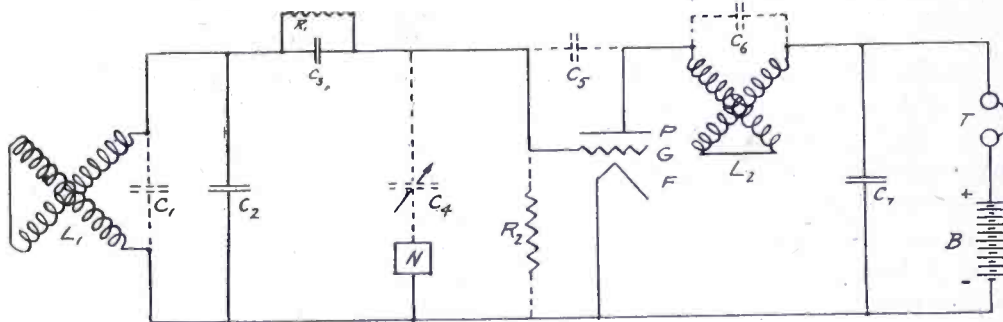

Fig. 1. Tuned-Plate Tuned-Grid Circuit

The tuned grid circuit is composed of an inductance  $L_1$ —in this case a variometer—and a capacitance  $C_2$ . The rest of the grid circuit is the 1 megohm grid-leak  $R_1$  and the blocking condenser  $C_3$ , which assists detecting action.  $C_3$ , if small, prevents the effective tube capacitance  $C_4$  from seriously changing the tuning frequency of the grid circuit except when the condenser pointer  $C_1$  is at the lower part of its scale.

The peculiar effect of the tube is always to add a new capacitance and series resistance in parallel with the grid circuit, as shown by the equivalent condenser  $C_4$  and the equivalent resistance  $N$ . The latter is always a true or positive resistance and reduces the signal response when there is no inductance in the plate circuit, i.e. when capacitance or resistance coupling is used. This is also true when a plate inductance having a high resistance is used.

The amateur wants to know what is the worst effect of these added elements on tuning. Are they most serious in a circuit with—or without—a blocking condenser  $C_3$ ?

This may be answered as follows: The tube reaction in a radio-frequency amplifier with resistance coupling has no effect on the tuning, because the equivalent resistance and series capacitance at  $N$  and  $C_4$  are in parallel with the grid condenser  $C_3$ , and have impedances which may be considerably greater than the actual resistance of 600,000 ohms existing between grid and filament. The equivalent capacitance  $C_4$  is several times—on an average 10 times—as large as the actual "geometrical" capacitance between the grid and filament. This simply means that it has less effect on the current passing between grid and filament and on the tuning point.

would give the best results when the telephones  $T$ , battery  $B$  and condenser  $C_7$  are replaced by the grid and filament of a second amplifying tube.

In the above condition, the absence of the blocking condenser, just considered as a tuning factor, would produce much detuning; as it would allow the tube to have its full effect on the tuning; whereas when  $C_3$  is present this effect is cut down to about half. In other words, any capacitance added by the tube has the effect, when  $C_3$  is used, of decreasing the tuning frequency or increasing the tuning wavelength—which is the same thing—by about 30% at short wavelengths.

The next point about a regenerative set is the relative effect of the tuning capacitance  $C_2$  and the blocking capacitance  $C_3$ .

We are now on the horns of a designer's dilemma, as  $C_2$  must be as small as possible. The smaller it is, the greater is the amount of negative resistance which is put into  $N$  by the tube at a given frequency, with an efficient inductance at  $L_2$ . But, on the other hand, the greater is the effect of the blocking capacitance  $C_3$  in changing the tuning point due to the capacitance of  $C_2$ . The latter may have its normal wave scale—at short waves—changed by 50 to 100%. This widens the scales—i.e. makes tuning less critical—and may be an actual advantage for fine tuning if nearby stations are using undamped waves. It is a bad situation for QRM from amateurs with "ragged" transmitters, as it becomes more difficult to escape them with vernier condensers.

Now suppose  $C_3$  is out altogether, or that we are using regeneration in radio-frequency amplification as the English do. What happens then? The effect is to reduce our regeneration; since the



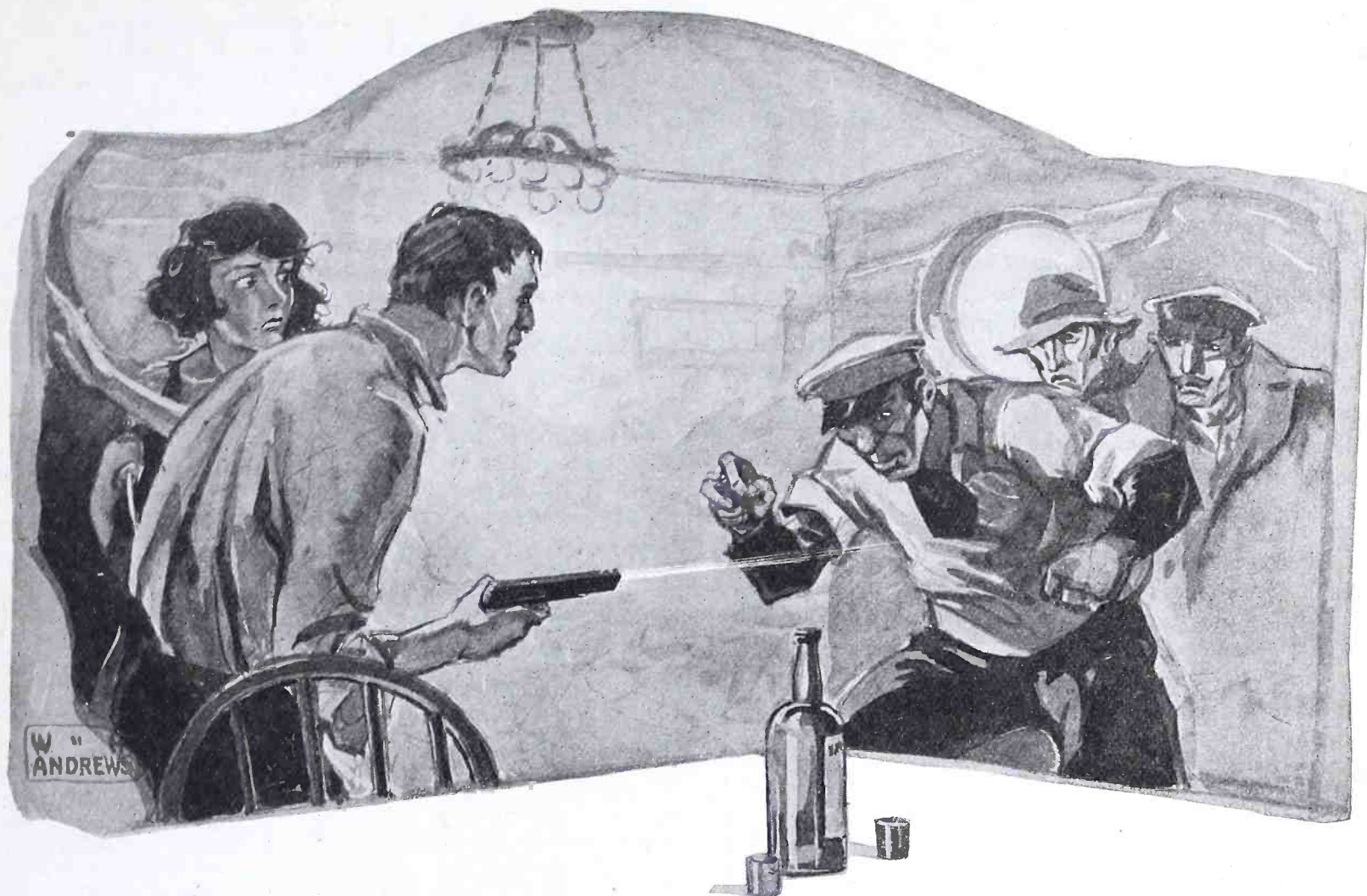

"Ashbrook's arm suddenly stiffened and the automatic cracked."

## A Radio Piracy

By Harry P. Bridge, Jr.

IN the tiny radio cabin aboard the yacht *Rosewood*, Captain Glenn Ashbrook and Jeffries, his radio operator, toyed with the big set and mused over the numerous connections with the great reaches of land and sea it opened to them.

"It sounds improbable, but there isn't one of those codes that couldn't be transcribed with a little effort," said Ashbrook removing his receivers from his ears, "Of course the general run of coded messages are easy compared with the important national codes but so long as its code I'll wager not an operator in a hundred ever bothered himself to take down more than one or two, much less figure one out. According to authorities it's impossible to conceive a code that cannot be deciphered."

"That might be—according to science," replied Jeffries, "Some men might get queer enough over codes to be able to figure out most any of them the same as one in a good many millions is a wiz at chess. But operators like myself might just as well save themselves the time. Even these common codes are hard enough to keep most fellows puzzling a long time and so they're safe so far as being understood is concerned."

"I guess you're right," agreed Ashbrook, "For a man who's not interested I

don't suppose it would do him any good after he did have it deciphered. It's fascinating though."

Here he was interrupted by a ticking from the instruments on the table. Jeffries listened intently to the repeated telegraphic signals.

"One of the coastal stations calling a ship," he explained to the captain who knew little of the wireless telegraph code, "Can't tell the boat's call though—given in code. They must be mighty particular about it."

"Why not copy it?" suggested Ashbrook.

"For you to untangle?" countered Jeffries, "I'd rather spend my time with a snappy story."

"All right, just to show you," replied the young captain, "Take it down and I'll have a look at it."

The signalling had ceased as the coastal station stood by and waited for a reply. Soon they located it, somewhat fainter than the former's call, and Jeffries started to tune his instruments.

"Going to talk a bit," he explained, "We'd better both take it so's to be sure there are no mistakes."

Soon the listeners heard a voice calling—the coastal station sending its invisible feelers out over many miles of tropical ocean waves to some distant ship. They

had switched from the monotonous telegraphic clicking of dots and dashes to radiophone and the speakers' voices could be plainly heard. The thing seemed improbable—ghostly, these invisible voices speaking from out the air.

"Hello—hello—one, two, three, four, five, XZX hello—XZX—hello—hello," was repeated slowly, distinctly, until there came a like answer from the ship.

"XZX can you hear? TSN calling XZX."

"Yes, XZX can hear TSN."

"G-Y-A."

"Go ahead."

And then the coastal station went on with a seemingly endless string of carefully pronounced letters and figures:

El Dorado: iuq (4), ebjha (23), (32), inn (47), fy?b (17), ewy (44), vybhyqya (39), vjfqibi (7) fy?b (34), wy?qjfs (48), ei (37), a?ny (24), ewy (30), eoyfeg (38), (40), (49), ewja (14), gidb (36), (2), v?fa (21), (11), (20), ?uifs (10), ?fq (33), ?ti?bq (29), (46), yfsjfy (26), uifs (19), ydyfjfs (16), (31), (3), ejvyq (35), oyae (1), (41), uih?ejif (45), o?ehw (42), (13), xu?g (15), yzxuiqy (5), (12), owyf (25), (22), tivt (6), ify (28), vifq?g (9), (22), xu?feyq (8), (18), xy?bua (22), (43).

"Yes—shall I read back?"

Jeffries, without waiting to hear the message repeated, abruptly cut off from the conversation.

"Well," he said laughing, "There's your code—now all there is to do is figure it out."

"That's all," replied Ashbrook lazily stretching back, "Perhaps I'll do it tonight."

\* \* \* \* \*

A BUSINESS cruise to the Orient always meant a well appointed round of pleasure for Glenn Ashbrook and seldom was this business so pressing that it failed to leave him time for a lazy cruise in any out of the way place that struck his fancy. Indeed, the speedy little *Rosewood* and its brawny, good-natured crew and captain were well known on oriental seas and those who gossiped of the lore of the sea and its shores in that region frequently spoke of them.

But there are many dull moments even in the life of the sea-faring adventurer. With his pleasure seeking finished and the *Rosewood* headed up the coast toward Manila, Ashbrook was becoming somewhat bored. The mystery of the radio set helped by way of diversion and consequently he spent considerable time with Jeffries in the little cabin.

Next morning he was up on deck earlier than usual with a slip of paper in his hand. "Well," he said to Jeffries as he breezed in the door, "Now let me show you."

He spread the paper on the table.

"See—any dumbell could tell that they just transposed the letters and symbols of the alphabet so that *A* would mean *S* and that kind of stuff. All you need to do is go by the prescribed formula for code transcribing to get it. Poe made a public curiosity of it a long time ago. More *E*'s than anything else and then the *A*'s and so on. Transpose if you aren't sure what stands for a certain letter until the thing begins to make sense. Then you find it reads like this:

El Dorado: old (4), tricks (23), (32), off (47), near (17), the (44), Mercedes (39), Mindoro (7), near (34), heading (48), to (37), safe (24), the (30), twenty (38), (40), (49), this (14), your (36), (2), mans (21), (11), (20), along (10), and (33), aboard (29), (46), engine (26), long (19), evening (16), (31), (3), timed (35), west (1), (41), location (45), watch (42), (13), play (15), explode (5), (12), when (25), (22), bomb (6), one (28), Monday (9), (22), planted (8), (18), pearls (27), (43).

"This is still enough of a jumble to throw the ordinary operator off the scent, continued Ashbrook, "if he doesn't happen to know the chess players' puzzle of finding a lot of figures, all different, to fill a block of squares that, added horizontally and vertically as well as crosswise through the center will give the same answer. Like this:

30	39	48	1	10	19	28	175
38	47	7	9	18	27	29	175
46	6	8	17	26	35	37	175
5	14	16	25	34	36	45	175
13	15	24	33	42	44	4	175
21	23	32	41	43	3	12	175
22	31	40	49	2	11	20	175
175	175	175	175	175	175	175	

The rest is easy. Each word in the code has a number that corresponds to one in the square where it should go. Put the words in instead of the figures and this is what you have:

30 The	39 Mercedes	48 heading	1 west	10 along	19 long.	28 one
38 twenty	47 off	7 Mindoro	9 Monday	18	27 Pearls	29 aboard
46	6 bomb	8 planted	17 near	26 engine	35 timed	37 to
5 Explode	14 this	16 evening	25 when	34 near	36 your	45 location
13	15 play	24 safe	33 and	42 watch	44 the	4 old
21 man's	23 tricks	32	41	43	3	12
22	31	40	49	2	11	20

"Just what do you think of it?" Jeffries studied the paper a moment; then he looked oddly at the captain.

"Does it mean what it says?" he asked, "or are you kidding me?"

"Not on your life!" snorted the captain, "I wouldn't have been up all night figuring it over if I hadn't an inkling of what it meant long before I finally got it straightened out. It's a matter of a little piracy, and the boys who sent this message have planted a bomb on this boat *Mercedes* timed to explode and put her helpless sometime out from port where the boat they have laying in wait with their confederates aboard can pounce out and relieve the *Mercedes* of her pearls before help comes."

"By golly, it does sound sensible—and then it doesn't," muttered Jeffries; then, after referring to his wireless call book, he added: "Here's her call. The *Mercedes*, Captain P. Fontaine, call WXS."

"Old Pendleton Fontaine!" exclaimed Ashbrook, "You've heard of him, Jeff. Cruised around these parts on his yacht a lot. I've heard he smuggled pearls and had other hazy dealings, and they tell me he's got a daughter, too, that's as game a sport as he is. They must be close to us now according to these bearings, and if the load is timed to go off tonight maybe we can reach them in time

to be of service—and have a little fun, too."

"Shall I try a call?" asked Jeffries.

Ashbrook hesitated. "No, we'd better not. Let's try and find out a little more about it first before we let them know anything about ourselves. I'll tell Mayes and we'll see if we can't find the *Mercedes* before tonight. Unless my deciphering's pretty bad someone's playing a high-handed game even for this region."

\* \* \* \* \*

THROUGHOUT the day the slim yacht sped onward in the direction indicated by the code. Speed the *Rosewood* could do and do well, losing none of her trim beauty in the effort.

Late in the afternoon Ashbrook's eagerness increased when Jeffries caught

an S.O.S. from the *Mercedes* near at hand calling for help. Ashbrook replied that they were coming and increased the *Rosewood's* speed to the last available knot. With the bomb already exploded, his remaining chance was to reach the disabled ship ahead of the pirate craft which must be lying close by waiting for this same signal of distress which would tell them of the success of their trick and be their signal to close in.

A premature dusk was falling before those on the *Rosewood* caught their first sight of the boat they sought. She lay out to sea on the starboard side dimly visible against the murky background of the oncoming storm and tossing helplessly on the rising waves.

By radio Jeffries received word from her to come closer, and, as they neared, Ashbrook could see people standing on deck. He could distinguish one in feminine apparel, and, stepping into his cabin so as to be unobserved, he trained his glass on her through the open porthole. Truly, Mercedes Fontaine was worthy of the praise he had so frequently heard accorded her by various globe trotters in many different ports where the yacht bearing her name had touched on her wanderings. It added to the consolation of knowing

Continued on page 54



Parentetically we use a sink rectifier and as a rule the motor remains running the whole time the operator is on duty.

To transmit, the button on the extreme left is pressed, when the left pilot lamp immediately lights. This indicates that we have closed the main 110-volt a.c. switch and started the motor. No juice is on the set till this button is pressed. Next, the left of the middle group of buttons is depressed, when the second pilot light functions, indicating that the filaments are lit on the tube set, and that the juice is available for plate supply. As those know who use "sinks," the polarity of the high potential is a matter of chance when the motor starts, and the remaining buttons are for the purpose of changing poles when necessary.

An experimental "dit" shows if the polarity is correct. If not, the proper button immediately changes it. We are now ready for work. The filaments are turned off and when correspondence is to be commenced one can do so instantly. The separate receiving antenna gives us a break-in. The key operates a pair of Western Union sounders at the set, one of which closes the primary of the plate transformer, the other cutting out part of the filament rheostat, thereby giving constant filament voltage. See Fig. 1, which more readily explains the details.

To say that it is a pleasure to operate such an arrangement is to put it mildly. The switches are absolutely silent in operation, and positively locked in both the ON and OFF positions. There is no chattering of contacts, and no failure of juice through rebound. Using a six-volt storage battery for both switches and relays, no hum occurs when operating, as is the case when a.c. switches groan! The core plungers go almost but not quite home, due to the spring contacts, so that the old familiar thump of a former design, so unpopular with the rest of the family in the wee sma' hours, is eliminated. When standing near the switch while it is in action the only sound heard when a button is pressed is a slight click due to the phosphor-bronze spring contacts closing, and the magnitude of this sound is best compared to the closing of a watch case.

Before actual building was undertaken the literature was searched for data on solenoids used for similar purposes. Here disappointment was experienced. The only articles discovered mentioning the type of switch desired gave specifications as to wire which were palpably incorrect. One author specified five pounds of wire per magnet! By computation it was found that a magnet suitable for our needs would not need in excess of half a pound of No. 22 DCC wire and would give us half an inch of pull measurable at  $\frac{3}{4}$  of a pound. The entire solenoid is enclosed in iron, using pipe for the cylinders and pieces of wagon tire obtained from a blacksmith

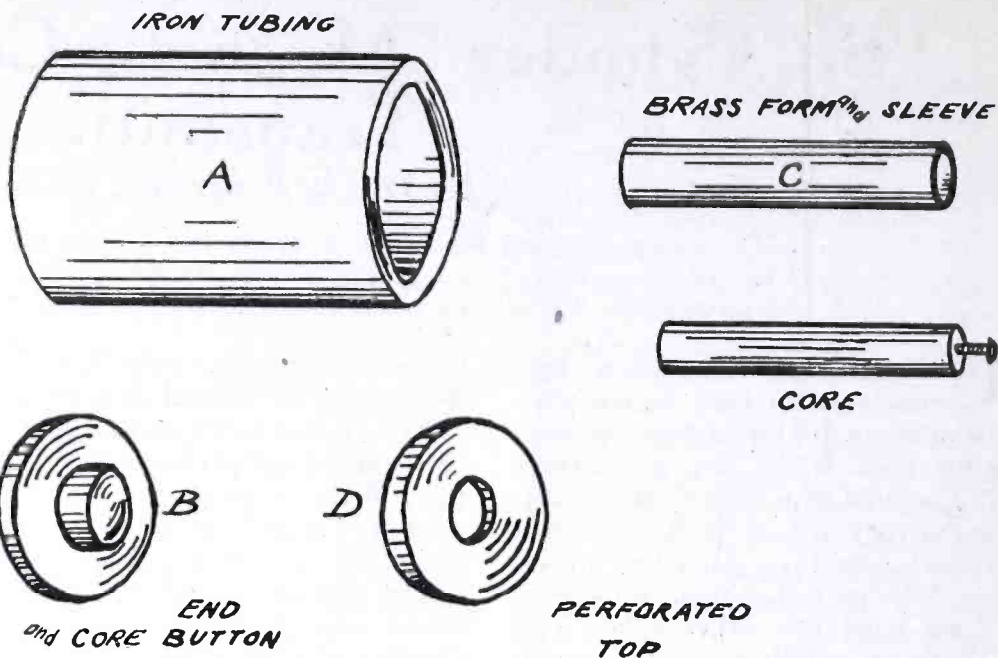

Fig. 2. Details of Solenoid Housing and Core

for the end plates. The winding form is brass tubing, which forms the sleeve for the plunger-cores. By utilizing iron in the field of the solenoids we avoided extravagant wire consumption.

The most puzzling problem confronting us was the choice of method for applying the magnetic pull to the switch contacts, in order to have mechanical simplicity and electrical efficiency. Many plans were tried and discarded, including rotating cylinders and discs, rods with spring attachments, etc., but the final choice was made by Mr. Sloane and enthusiastically endorsed by me on demonstration. The method adopted is possibly the simplest and certainly complies with all requirements. In addition, it is about the cheapest as to material employed.

Referring to the details of some of the components, attention is invited to the several diagrams submitted. It has not been thought necessary to furnish sizes and measurements, as most amateurs interested in the acquisition of similar apparatus will find reasons for modifications. The base board of the complete control, however, is 7 by 10  $\frac{1}{8}$  in. and the over-all height 8 in. From the pictures the relative proportions of the integral parts may be readily computed if desired.

Fig. 2 shows at A the iron pipe, 2  $\frac{1}{2}$  in. stock, and the end plate B is made to be pressed home. A small button of iron projects into the brass tube C to assist in producing a strong magnetic pull as well as reduce the air gap. The

top end plate D has a central opening to accommodate the brass sleeve in which the core plunger operates. The plunger has at its free end a machine screw for attachment of the connection to the contact lever as shown in Fig. 5.

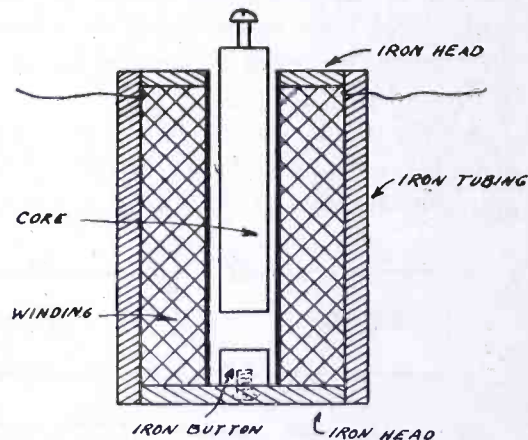

Fig. 3. Solenoid Assembly

Fig. 3 shows the solenoid inside the iron housing. There is half a pound of No. 22 double cotton-covered copper wire on each winding, the ends being brought out at the top of the unit through empire sleeving. A small felt pad is placed at the bottom of each plunger chamber to obviate a knock in case of future stretching.

Fig. 4 indicates the form of the phosphor-bronze spring contacts which are reinforced at the tips, preferably with silver plugs the size of a dime. These springs are bolted to a fibre block which in turn is mounted on a shaft common to two other similar units, thus giving three double pole switches. The center

Continued on page 76

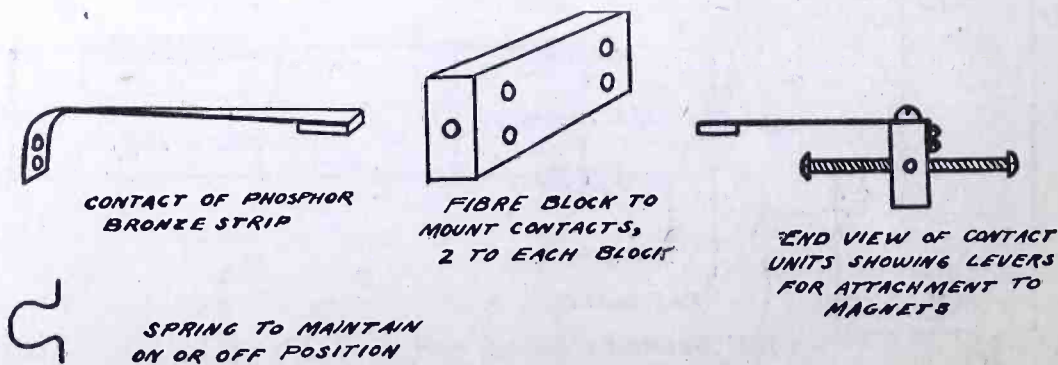

Fig. 4. Contact Details

# Reducing Transmitter Interference

By Edward T. Jones, I. R. E.

*If the amateur is to retain present transmitting privileges and possibly regain those lost, he must prove himself worthy. These practical suggestions will help him to do so. They include filter circuits, rectifiers, and coupled antenna-ground connection.*

TOO few experimenters with transmitting sets have made up their minds that they should show a little "brotherly love" for their BCL friends. Too many transmitting sets are put together as fast as it is possible to do so and with whatever material happens to be available. This does not provide an efficient transmitting set, free from causing much interference to friends who are interested primarily in broadcast reception.

Personally, I have a great regard for the transmitting amateur; for, while I have had to take down my transmitting set due to the lack of space for an efficient antenna system, I am now in position to erect the proper antenna for a 50-watt transmitter and 5FW will soon be on the air again. But, when I do get on the air, it will be in such a way that my set will not cause any interference whatsoever to the broadcast listener. I am going to work as low as it is possible to do so under the present regulations and provide proper rectification and filters to eliminate the awful a.c. hum sent out by most amateur transmitters.

The average experimenter is anxious to get as much as is possible from a given tube. If he would pay less attention to radiation (as shown on the radiation meter) and more attention to the over-all efficiency he would cover greater distances and cause less interference to the broadcast listeners.

If he would operate a 10-watt set (2 5-watt tubes) as he would a 5-watt set for output, he would cover the same distance as would be possible with the ten watts overworked. Working at this point of efficiency he would cause very little if any interference.

It is, indeed, a simple matter to provide proper rectification and filter circuits. There is no guessing at it. The R. C. A. offers a 50-henry and a 40-henry choke filter reactor. The selection of condensers to work with these filter reactors is a matter of much speculation at the present time however, and the writer wants to point out how best results are obtained as demonstrated on several sets.

In Fig. 1 three different filter circuits are given, any one of which may prove best suited for your set, depending upon the circuit you are using. It is best to experiment with each of them and use the one which works best on your particular installation. It is a 100-to-1 shot

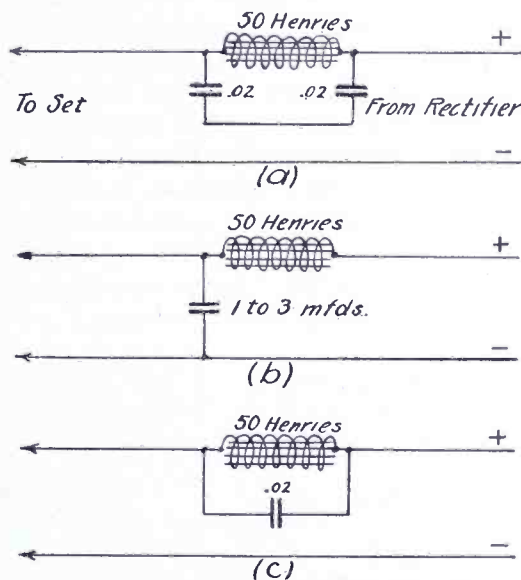

Fig. 1. Three Good Filter Circuits

that one of them will fit any circuit in use today.

This business of throwing together as much iron and wire as is available and then shunting this with as many condensers as can be found must stop, otherwise we are going to have the BCL climbing right up on our necks. We have enough trouble now to get through the CQ artists without having the wrath of the BCL heaped upon us. There is no legitimate excuse for anyone putting up a transmitting set unless he means "business." Unless he means to co-operate with the amateurs, experimenters and BCL's he has no right to the air and the radio inspector should pick up his license. So dig in fellows and help the other OM's perfect their transmitting sets. Point out the defects and, if necessary, go home with them and spend the afternoon with a shovel clearing up the 1 mfd. condensers and iron in the filter circuit.

With regard to rectifiers, it is certainly better to under-rate the capacity of each jar and add more of them. This will result in a little less voltage at the filter terminals—but it will assist materially in getting away from the AC—which is the only reason the rectifier is installed. You may get a 64th of an ampere less radiation but that will not stop you from getting through—and much easier at that. For best rectification I recommend the following sizes of aluminum and lead plates: For 5 watt tubes strips 1/2 in. wide by 3 in. long 1/8 in. thick; for 50 watt tubes strips 1 in. wide by 4 in. long 1/8 in. thick. Allow 100 volts per cell—that is if they are properly formed. If this does not give you DC then add more jars. It

would be even better to allow 75 volts per cell maximum. This, of course, depends entirely on the construction of the cells, the solution and the purity of the metal used.

Much interference is being caused by CW transmitters directly connected in the aerial-ground circuit. Better results can be secured with the hook-up shown in Fig. 2 where the antenna system is

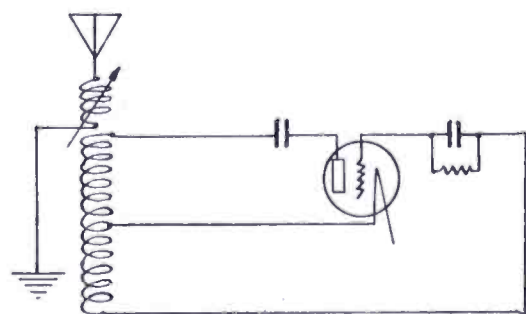

Fig. 2. Inductively-Coupled Transmitter

inductively coupled to the oscillator. This will permit of great selectivity and higher efficiency. When operating locally the antenna coil can be turned nearly at right angles to the oscillator coil and communication be carried on without disturbing anyone, no matter how close to the transmitter itself.

## THE LANDLORD'S LAMENT

By P. S. LUCAS, 6FO

Wires a'danglin' out the windows of my  
fourth floor two-room flats;  
Wires a'stretchin' from the chimney to the  
eaves;  
Wires a'runnin' down the staircase and un-  
derneath the mats;  
'Till I get caught among the network that it  
leaves.

Oh, it's wires for the ankle,  
And wires for the chin.  
And some are laid with special care  
To keep the tenants in.  
Some set for the landlord,  
And some fixed for the maid;  
But the wires that make the landlord swear  
Are the tangled ones, un-laid.

Wires a'runnin' to the flag-pole, and to every  
kitchen sink;  
Wires a'goin' to the bedsprings and the  
screens.  
Wires hidden in the closets, all tangled and  
all kinked,  
Make the landlord's life so pleasant that he  
screams.

And it's wires from the knee, up,  
And from the shoulder, down.  
Wires stretched along the top,  
That keep you turnin' 'round.  
Wires swingin' overhead,  
An' draggin' on the ground.  
They ought to have asylums  
For these useless radio hounds.

# Neutralization of Tuned Radio Frequency Amplifiers

By Thomas W. Benson

*Here is a novel method for securing efficient tuned radio-frequency amplification. Neutralization is obtained by capacity feedback with unity coupling. Only one condenser is needed to control both the plate and the grid circuits.*

THE advent of the tuned radio-frequency amplifier had been long delayed by lack of efficient means for controlling the oscillations in the circuits when they are tuned to resonance. That this was a serious problem can be more readily realized when it is considered that the tuned radio-frequency amplifier as most generally known employed a circuit that was identical with that used to produce regeneration, namely the tuned plate regenerator. The problem was then how to tune the plate without causing the system to oscillate.

Many and clever were the schemes put forward for the purpose, the simplest being the use of a potentiometer or a "losser" which added resistance to the circuit and thus absorbed the energy feedback into the grid circuit fast enough to prevent the circuit from oscillating. The only defect this arrangement had was the loss of signal strength and selectivity, the effect being so pronounced as to make the method impractical.

Then various forms of negative feedback were tried, of which the more important surviving are the capacity neutralization due to Hazeltine and the reversed tickler feedback as used in the superdyne. Both of these systems work efficiently when properly handled, but both have inherent disadvantages. The chief defect of the Neutrodyne system is that neutralization at all wavelength settings is difficult to obtain because the transformer coupling gives other than unity coupling co-efficient between plate circuit and grid circuit of the next tube. The result is an unstable circuit at some settings or over neutralization at others. The superdyne on the other hand uses an inductive feedback to balance a capacity feedback through the tube. Therefore an adjustment of the neutralization is necessary for each change of wavelength. This is not difficult to do when but one stage of radio-frequency amplification is used and leads to an advantage in obtaining maximum signal strength and selectivity.

It is well known that the greater the tendency of a radio-frequency amplifier to oscillate the greater will be the amplification, but the instant sustained oscillations start the amplification drops to zero. With the superdyne it is possible to push the circuits to the point where they are on the verge of oscillating and thus obtain maximum amplification.

In view of the above facts the writer has developed a radio-frequency amplifying circuit that possesses the good features of both circuits and eliminates their disadvantages. Capacity feedback is utilized, but the coupling coil is so

arranged that unity coupling exists between the plate circuit and neutralizing winding, giving constant neutralization over the whole range of wavelengths. On the other hand this balancing is made adjustable so when weak signals are received the circuits can be unbalanced slightly to obtain high amplification without permitting oscillations. In addition a step up is obtained, a partial if not complete tuning control of both plate and grid circuits with one condenser by reason of a tight coupling that gives a good transfer of energy.

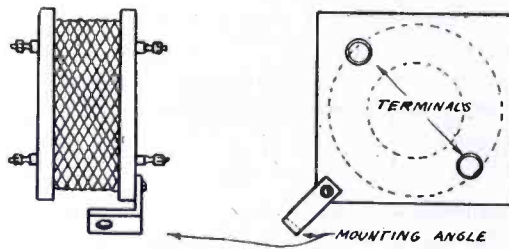

Fig. 1. Transformer Made from Honeycomb Coil

The aerial tuning as well as the intermediate tuning units each consist of one winding tapped at two places. The easiest and simplest method of making this inductance is to take a 75-turn honeycomb coil, strip off two turns and count back 15 turns and make tap *C*. Counting back 15 more turns on the coil, tap *B* is taken off. The inside end of the coil is indicated at *A* and the outside end at *D*. The coils can be mounted in any desired manner and terminals arranged as shown in Fig. 1, where the coils are clamped between two pieces of bakelite, but when placed in the set they should lay at right angles with each other with at least 5 in. separation between centers. Mounting the coils directly on the tuning condensers is the simplest form of mounting.

Returning to the circuit proper. It will be seen that the portion of the inductances between points *A* and *C* forms the grid inductances of the tubes. This inductance is tuned by the .0005 mfd. variable condensers. The first coil is coupled to the aerial circuit by reason of the turns between *C* and *D* acting as an untuned primary circuit.

In the coupling between the first and second tube the portion of the winding between *B* and *C* forms an untuned plate circuit closely coupled to the tuned input to the second tube. The 15 turns at the bottom of the inductance is connected through a small variable condenser (Midget) of about .00004 mfd. to the grid of the first tube. This forms the balancing circuit, for it will be seen that any tendency of the potentials at *B* to feedback through the capacity of the tube to the grid is balanced by an opposite potential at *D* fed back through the variable condenser.

The fact that the plate voltage is applied to the grid inductance of the second tube makes it necessary to use a grid condenser of .001 mfd. to block this voltage, as in the usual tuned plate circuit, while the grid leaks to the filament through the grid leak shown.

The same arrangement is repeated in coupling to the third tube except that a small blocking condenser of .00025 mfd. is used to obtain detection in connection with the grid leak to the positive filament lead. The usual audio-frequency amplification can be employed as shown.

The circuit is balanced out like the neutrodyne to obtain a point of balance for the stabilizing condensers. Normally the condensers are kept at this point while tuning, but once the signals are picked up they can be increased by slightly unbalancing the circuit by adjusting the small condensers.

The circuit functions equally well with the different hard tubes, allowing, of course, for the difference in the output of the various types of tubes. In practice the amplifier tubes can all be on one rheostat with the detector on another. A hard tube in the detector stage works satisfactorily, but a soft tube with lower plate voltage is slightly more sensitive to weak signals.

This circuit has proven very satisfactory in use, handles like a neutrodyne with the exceptions noted above, dial settings can be logged and, as a whole, it is very selective.

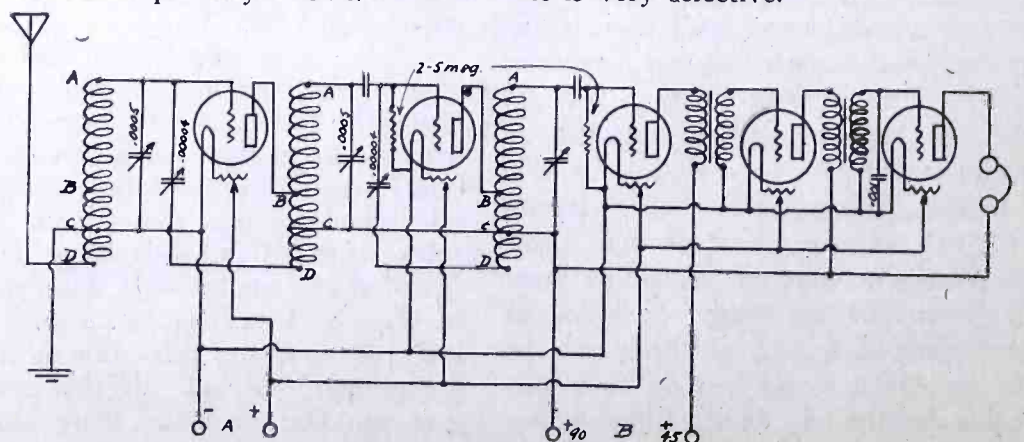

Fig. 2. Circuit Diagram

# The Plate-Tuned Revamped Again

By L. W. Hatry, 5XV

*The reader wanting to stay by the old reliable regenerative set, modified to minimize radiation, will find these directions well adapted to home construction. They have been the basis for making many sets which are in satisfactory use.*

**I**N spite of -dynes, -plexes, and other different and queer hookups, the regenerative one-tube set, because of its economy, simplicity, and safe-fire results, has lost neither its popularity nor its sensitivity. Because a great many still use regeneratives and a great many more will use them, I believe the description of a general type of regenerative I have built for music reception will be of interest. The circuit is merely an adaptation of the plate tuned.

same wire, this being  $L_1$ .  $L_1$  could just as easily be wound on top of  $L$  so that the splitting of the winding is not necessary if you should not care to do it. Also  $L_1$  could be wound at the end of  $L$ , in which case four to six turns would be necessary to keep up the signal strength. Some times it is necessary to have more than two turns in  $L_1$  because of inefficient apparatus. You can determine that by your results.

$L_2$  is sixty turns of the same size wire

The variable condenser  $C$  is a 23-plate and should be a good one; an 11-plate condenser will cover the range of broadcast waves if the coil  $L$  is made with 75 turns.  $C_1$  is the grid condenser and should have a capacity of .00025 mfd. and of course should be mica insulated. The grid leak  $GL$  is optional. It should be two megohm for the 200 or soft tubes and four megohm for the 201a, 199, 12, 11, and other hard tubes, if you decide to use one.  $C_2$  is also a mica type condenser and should be of .00025 mfd. capacity. The rheostat should be 30 ohm for the 199 and 10 ohm for the other types of tubes mentioned. As a general rule with this type of receiver it is not necessary to have a vernier rheostat for the filament will not be found to be a critical control.

See that the rotary plates of the variable condenser go to the ground. Mount  $L_2$  at right angles to  $L$  and  $L_1$ . Place  $L$  close to the variometer  $V$  as shown in Fig. 2. The polarity of the variometer is important and if you have it connected wrong the set won't oscillate. To get it right, check the direction of the windings of the grid coil  $L$  from the grid

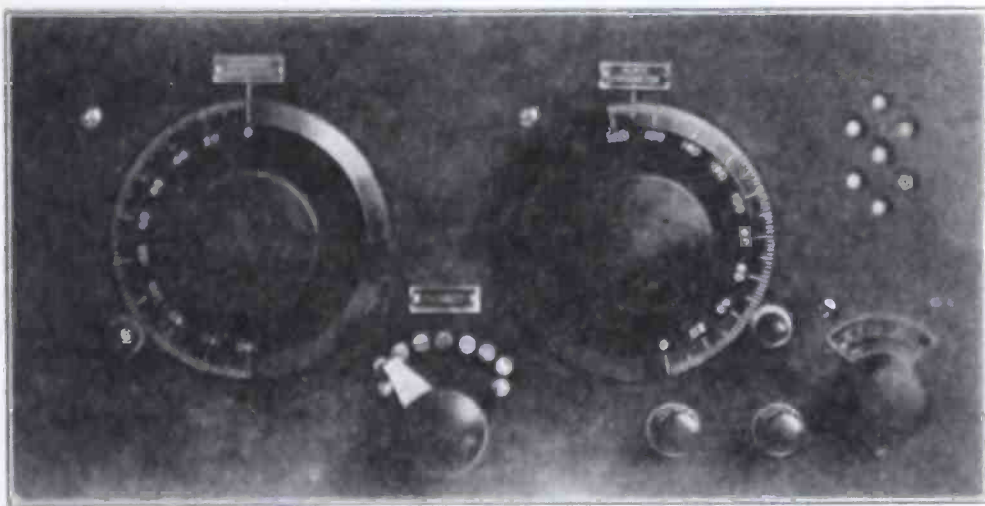

Fig. 1. Panel Arrangement

These things can be claimed for this set with full honesty:

1. Good selectivity—better than single circuit.
2. Excellent signal strength.
3. Minimum radiation — transmits squeals hardly at all.
4. Full control of volume.
5. Good distance reception.

In Fig. 3 is given the schematic diagram.  $L$ , the secondary coil, is a 65-turn coil wound on a 3½-in. diameter form of cardboard treated with spar varnish. No. 20 DSC wire is used. Cotton-covered wire is also OK.  $L$  is split sufficiently in the center to allow the winding of two full turns of the

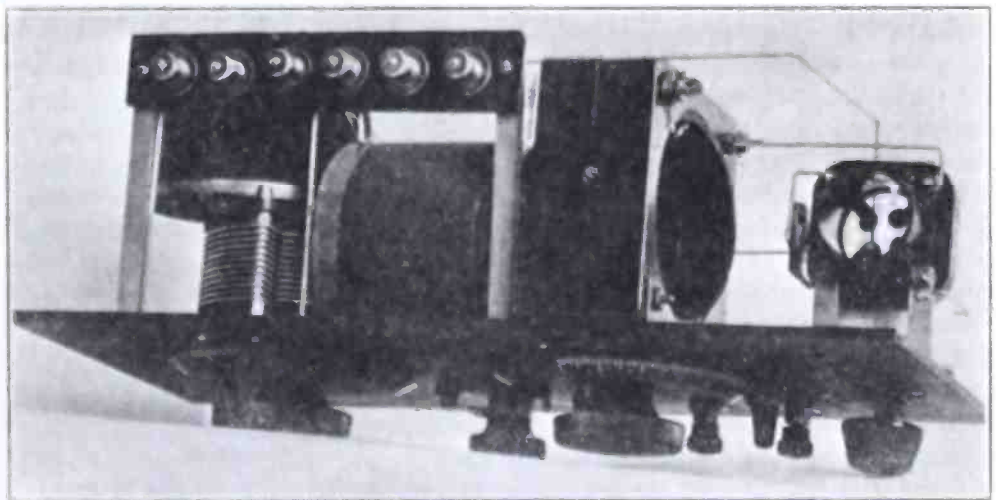

Fig. 2. Side View

on the same size form, but most likely, due to space restrictions usually, a smaller size wire and coil length will be preferable, in which case use No. 24 wire.  $L_2$  should be tapped at six places and a tap taken from the beginning so that seven taps will be obtainable. Tap the coil at the 5th, 12th, 20th, 30th, 43rd and 60th turns.

The plate variometer  $V$  should be one whose wavelength range as given does not normally go higher than about 450 meters, although any variometer will serve. The thing is that a smaller variometer than usual will work well with the arrangement of the apparatus as arranged in Fig. 2.

and connect the variometer so that its windings when helping or at maximum go in the opposite direction from the plate of the tube. The  $A$  battery polarity is given but it might be just the opposite and that is easily determined in a minute by reversing the connections of the battery. Sometimes the  $A$  battery polarity does not matter.

Dimensions are easily taken from Fig. 1 by remembering that the panel is 7 in. x 14 in., although there is no need to religiously follow my arrangement. I don't myself. The panel appearance is fairly well balanced and neat. Verniers as you see are on both controls although

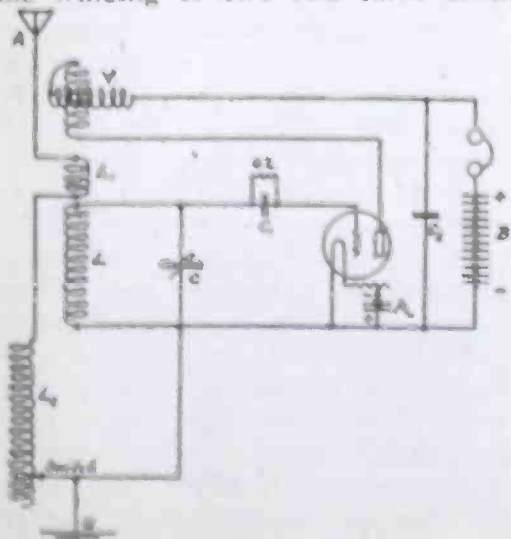

Fig. 3. Circuit Diagram

Continued on page 51

# The Finger of God

By B. W. Fordham

*After all is said and done, the real romance of radio is at sea. This soul-stirring account of the early use of the radio compass possesses a real human interest. It might have happened to you or to me.*

HOW often, of late, do we hear these old salt-bitten masters of deep-sea tramps bewail the passing of the "good old days before radio." Gone are the days when a captain could wash his hands of the restraining orders of ship owners as soon as his vessel had cleared from port. No more can the master lay his courses and say to himself: "I shall do thus and so! We will arrive such and such a time. —" Nowadays he lives, from hour to hour, in the expectation of a change of orders—by radio.

Sometimes the necessary change of course will throw the vessel into the teeth of a blow that she had been comfortably riding through before. If such should be the case, then needs must poor "Sparks" be prepared for an avalanche of abuse. 'Twould seem, from the no-wise gentle expressions of the "Old Man" and the grumbling of his mates, that the order had originated with the operator. Radio is let in for the most unmerciful razzing, and the "brass pounder," who perhaps had just achieved a brilliant victory over great DX or heavy QRM in reception of the message, is made to feel lower than the little pot-bellied fish that swim at the bottom of the sea. If the operator be new,—one of the tender "vacationist" breed—unused to the two-fisted methods and the vitriolic tongue of the man who "goes down to the sea in ships," he is likely to take the seemingly uncalled for outburst to heart. Should he reply in kind, then indeed will his life be made a thing of misery.

Memory serves me with an occasion, some few years ago, when a series of countermanding orders placed our ship in a rather ticklish position. The great Mexican oil boom was at its peak. Tankers, in swarms, were pouring down through the Florida Straits, across the Gulf to Tampico, Tuxpam or Puerta Lobos and back again to the country north of Hatteras.

My berth, the good ship *Brewster*, was nosing her way steadily northward; deep in the water with her belly full of the "black gold" that men were going crazy over. About abeam of the Frying Pan Shoals, I think we were, everybody living in high expectations of a pleasant time ashore in New York, when the air was rent by a call from the navy boy, who reined supreme in those days, on Hatteras. It was with a sinking of the heart that I threw my 2 KW into action and told NDW to shoot his stuff. Sure enough! It was one of those hated order messages, worded in the same old peremptory manner:

"Cancel previous orders. Proceed Montreal for full discharge. Acknowledge."

The skipper took it rather well, considering the fact that the trip in to New York would have given him his first glimpse of wife and family for many months. He grumbled a bit over the rotten weather we would run into in the St. Lawrence country so early in the spring, but when we passed abeam of Hatteras, the *Brewster* kept her nose steadily to the north and east until soon we were many miles off the coast. Were it not for the continual heavy jam of radio traffic filling the air the whole day through, New York might have been a million miles away for all I was concerned.

About the latitude of Nantucket we ran into the fog. For days we were shrouded in a big white blanket, as thick, and still, and clammy as an atmosphere of clabbered milk. Steadily forging northward, our navigators did not get a "shot" at the sun or stars for three solid days. Our course lay too far out to pick up the lightship at Halifax, so it was upon dead-reckoning alone that we were edging in to the desolate coast of Cape Breton Island, whose northern end was to be rounded ere we headed up the Gulf of St. Lawrence.

What a night it was,—that one on which I received our second change of orders. We were poking along in a world gone white, with the halting gait of a blind man threading his way through downtown traffic. Engines were turning over at slow speed, stopping entirely every now and then to drift by some honking fisherman, or other bellying monster gone blind.

The captain's outburst could well be pardoned when I brought him that message in the midst of the night, ordering him to put back into the port of Halifax. He tore his hair, and registered acute indignation in that cyclonic style so typical of deep-sea masters. He radiated wrath from all his loose ends—Like the brush discharge on a leyden jar.

"Who the hell is running this ship anyhow?" he exploded. "I might as well turn her over to you. There is only one man aboard a ship nowadays and that's the cockeyed operator. No peace for anybody since you fellows started to go to sea."

I stuck my tongue in my cheek and very meekly said, "Yes, sir."

"I don't know exactly where we are," he fumed. "This may delay us for days,—or pile us on the rocks, if the fog doesn't lift. A fine coast this is, for a man to double back on his wake and

hunt a hole like Halifax after three days without an observation."

Indeed the position was rather ticklish. That strain, which is now and then forced on the operating personnel of a ship in the clutches of perverse weather conditions, was felt by all,—even the messboys, who scurried around their pantries with a scared look in their eyes. It is easy to picture again that night. The jagged coastline, boiling with a surf that meant sure destruction to any ship which might blunder into its grasp. Over all a blanket of swirling fog; so dense that the eyes could pierce it but a scant few yards. Out there in the fog bank, a tiny hunk of iron, manned by some two score human souls, hesitating just which way to turn, to find the little hole in the breakers where safety lies.

Then it was that radio stepped in and far more than made up for the trouble it had caused. Those were the days when the radio compass was in its infancy. The captain had no faith in radio bearings, in fact had never had occasion to use them. The *Brewster* had recently been fitted with the 800 meter wave, but so far I had never used it. Here indeed, was an excellent opportunity for a trial of this new method of navigation. I am quite certain that the skipper firmly believed that any "dope" I could get would indicate the ship's position as being out in the middle of the North Atlantic, or possibly up on dry land, somewhere in the vicinity. However, he gave me rather sneering permission to see what I could do.

A station on Chebucto Head, at the entrance to Halifax, and another at the Gut of Canso, were among the pioneers in the trial of the radio compass. I never hear—now in later years—the long drawn MO of the Compass Test but what I think of that night when first I worked VAV and VAX.

The feelings that came over me, as I sat down to my set, were peculiar. The physical phenomena of radio was forgotten. The motions my hands went through, at switches and key, were subconsciously directed. The first call was answered, sharp and clear, with the direction to go ahead and test. Following the newly issued instructions to operators requesting bearings, I began throwing out my da-da, da-da-da's. Those two minutes were, I think, one of the longest periods of my life. With every long drawn dash I sent along a little prayer, that the wave-trains of my call would speed straight and true to the distant

*Continued on page 58*



# Direction Finding for the Amateur

By Wallace Kelk

*These are practical instructions for the construction of a loop which is useful for locating sources of interference or transmitting stations. It is of especial value in sleuthing with a super-heterodyne receiver.*

**D**IRECTION finding is a very fascinating subject for radio endeavor. This study is entirely dependent upon the aerial. Of the various systems in operation the Bellini-Tosi system used by the British and Canadian governments requires far more space than is usually available to amateurs.

Therefore the most practical is the box type frame aerial, since it acts both as aerial and radiogoniometer. To transform it into a radio compass is simple and inexpensive.

First make a wooden box frame 2 ft. 6 in. square and 5 in. deep as shown in Fig. 1. Reinforce the inside corner with light brackets to keep the cube true and stable. Serrated strips of ebonite are then mounted on each of the 5-in. cross strips, the grooves holding the aerial wire the beginning and end of which are connected to double screw terminals from which the leads to the

receiving set are taken. Securely mount this box frame on a 4-ft. shaft whose base is screwed to the bottom of a box as shown in the illustration, this shaft being free to revolve.

On the cover of the lower box through which the shaft is passed, mount a 6 in. circle calibrated from 0 to 359 degrees. Fit a pointer on the shaft so that it runs flush with the circle in order that the angle of the received signals can be easily read.

The entire contraption is set up so that the 0 and 180 degree marks point due north and south respectively and so that the plane of the frame is also on this line as shown in Fig. 2. The pointer should be adjusted so that it is at 90 degrees on the scale.

Maximum signals will be obtained when the plane of the frame is in line with the direction of the transmitted wave, and this, of course, will be the

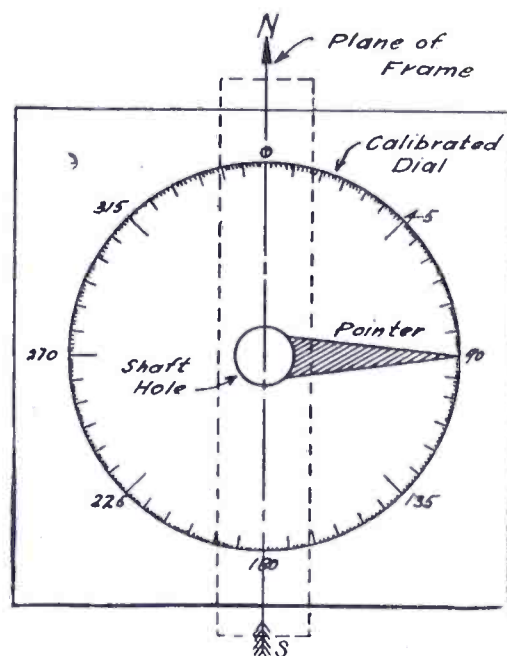

Fig. 2. Dial and Pointer

true direction of the received wave. But since it is easier to define minimum than maximum strength, bearings are always taken on the minimum. The setting of the pointer 90 degrees from zero automatically gives the minimum to be worked on, but this angle must always be taken into consideration when working out the sum, and either added to or subtracted from the observed bearing.

Minimums will be found covering anything from 10 to 60 degrees, but every effort should be made to reduce this to within as few degrees as possible. This can most easily be done by increasing the intensity of signals, which brings in a sharper minimum. Where signals absolutely fade the true line is thereabouts, but in order to obtain the exact number of degrees it is necessary to work each side until signals can be matched, the void in between being indefinite until the sum has been worked out. The two figures obtained are then added together, divided by two to arrive at the mean and the 90 degrees duly added or subtracted according to the direction of the observed station. Assuming the signal strength to match at 151 and 173 degrees the sum would be worked out as follows:

$$\begin{array}{r} 151 \\ 173 \\ \hline 2 ) 324 \end{array}$$

Mean 162 plus 90 = 252. True bearing

A plotting chart can be made up from a map of the area it is intended to cover. It consists of drawing a circle taking the position of the radio compass station as the dead center, and calibrating the

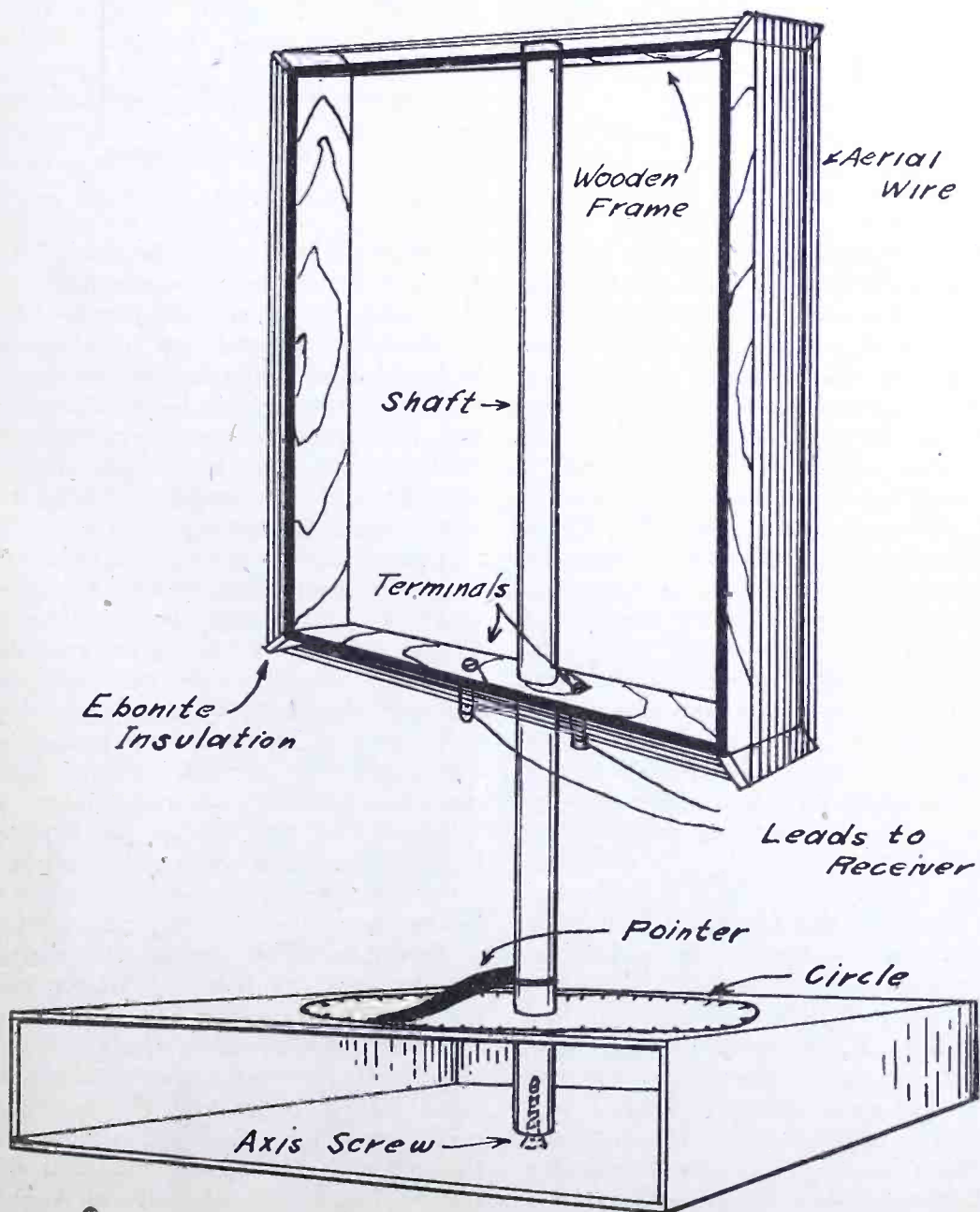

Fig. 1. Directional Aerial Construction

circle from zero, pointing due north, and working round from east to west to 359 degrees. If grouping in conjunction with other stations for the purpose of obtaining fixes by intersections, circles will have to be drawn in for them also in order that position lines can be run out.

A rough diagram of the method of plotting a fix is shown in Fig. 3, taking station *A*'s bearing to be 110 degrees, *B*'s 90 degrees, and *C*'s 35 degrees.

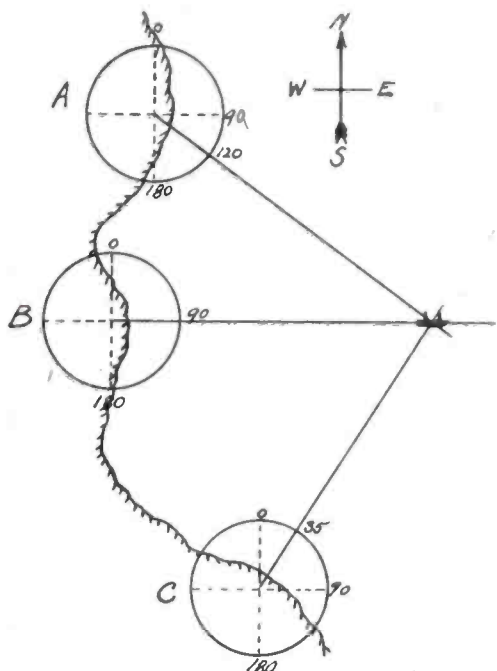

Fig. 3. Fixing Position from Three Stations

It will sometimes be impossible to tell which is the right minimum to use as a bearing may be taken in the opposite direction to which the station really is. When taking bearings on vessels at sea, however, and with land behind the direction finding station, it is impossible to go wrong if the operator works always to seaward. For checking purposes there are countless land stations whose true positions are easily ascertainable. By taking frequent readings on these and plotting on the chart, it will be possible to gage the accuracy of one's set and work.

Radio clubs might form groups of interested members to use this direction finder in competitive tests. For instance, not a little fun would emanate from a search for an "Elusive Pimpernel" who at specified times dropped in on various amateurs and sent prearranged signals which would enable the searchers to get a line on him; then, shortly after, turning up and doing the same in another quarter. Such a hunt might be extended over the course of a week with one or more clue tests sent out nightly. At the end of the search, the group submitting the most accurate fixes would be awarded the Iron Cross, or such honors as deemed worthy of the deed.

The outfit described may be depended upon for fairly accurate results over a 50 mile radius.

### ELIMINATING THE INTERFERENCE FROM A COTTRELL PRECIPITATOR

Until Col. J. F. Dillon, supervisor of radio for the Sixth district, visited Miami, Ariz., in April, radio reception there was continually interrupted by the radiated energy from a Cottrell electrical precipitator used to collect dust from the smelter fumes incidental to the large copper output of this district. As the prosperity of the district is dependent upon the operation of the mines, the radio fans most certainly could not urge that the precipitator be stopped and so had to endure interrupted programs. But Col. Dillon solved the difficulty and now the people of Miami are able to enjoy their radio programs.

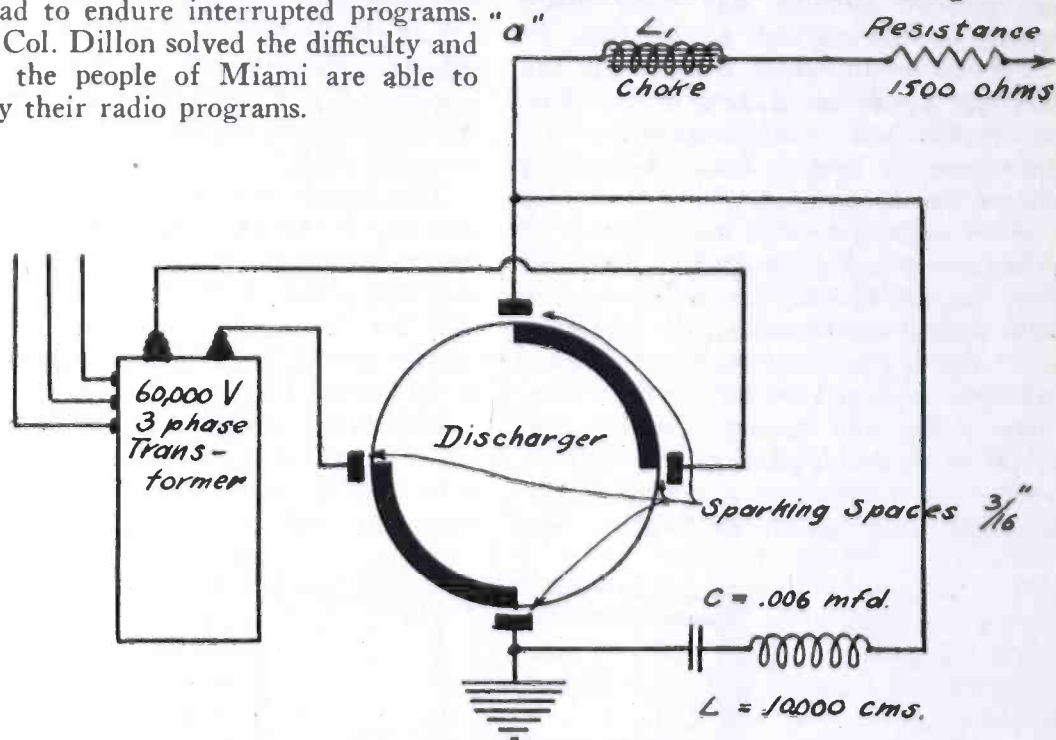

Connections of Cottrell Precipitator

As similar preventable trouble is being experienced elsewhere, the accompanying diagram of connections used at Miami should be of interest and value: The line *A* extended through the precipitator 214 meters from the rectifier. The standard formula indicates that the natural wavelength of this section is 450 meters, whereas the measured wave was 350 meters, indicating that forced 350-meter oscillations were being induced in the wire from the discharger.

The 1500-ohm resistance which had been inserted in the line close to the discharger apparently prevented the wire from conducting the oscillation but acted as a dead end conducting the induced oscillatory currents from the discharger to the precipitator when it was also induced in the surrounding power wires and thereby conducted to Miami and Globe.

To remedy this trouble a low resistance circuit *LC* was shunted around the discharger and the resistance moved to the metal wall of the building. An iron core choke *L*<sub>1</sub> consisting of 120 turns around 1½ in. laminated core was also inserted in the precipitator line.

With a value of .006 mfd. for *C* and 10,000 cms. for *L* it was found that they functioned normally without radiating the 350-meter wave.

### RADIO AS A STABILIZER OF GOVERNMENT

By B. G. HUBBELL

Democracy can live only through the most exacting publicity and clear understanding of the country's necessity—there must be a general accord. Already, there are signs of breaking down of our form of government, largely because of this lack of understanding, and I believe that this new radio science was projected into the world's necessities particularly to furnish an economic and easy method in overcoming this growing lack of political faith and understanding.

For the first time in the world's history there will be an opportunity for close exchange of political ideas. Most of the important political speeches will be broadcasted. The Republican speaker will be listened to by Democratic voters and vice versa and a very general and fair minded interchange of political thought will be possible, without the heat of political passion.

There are now ten million radio sets in operation in this country, all tuned and waiting for these political events. People, who have not heretofore been interested in radio, are fast installing sets and thousands of them are being daily tuned in for the express purpose of listening to the political thoughts coming from this political campaign.

Every man and woman is interested in politics. Every boy and every girl should become interested, if they are to become good citizens.

To my mind, our new sciences are not merely works of man. I believe they are commands of destiny—of necessity and I believe that radio—the greatest of all scientific developments—was brought forth largely to furnish the means of preserving our political structures through easy methods of wide and economic distribution of political knowledge.

# Improvements In Best's 45,000 Cycle Super-heterodyne

By G. M. Best

A NUMBER of very good suggestions for the improvement of the Super-Heterodyne receiver described in May RADIO have been received, and have been incorporated in a revised circuit diagram, similar to that shown in Fig. 3 on Page 11 of the original article. This revised circuit is shown in Fig. 1 on this page, with the various suggested changes.

The suggestion which wins first prize for June is a change in the volume control, to increase the stability of the set, and provide a more even, smooth control of the volume. In the original circuit, the filaments of the three intermediate frequency amplifiers and the first detector were placed in the volume control rheostat circuit, and it has been found that changing the filament current of the first detector tube changed the output impedance of that tube to such an extent that the small feedback condenser  $C_3$  often was of the wrong capacity value for a given setting of the volume control rheostat and the set would occasionally oscillate. By removing the negative filament connection of the first detector tube, and the last intermediate frequency amplifier, from the volume control circuit, and connecting the filaments as shown in the diagram, this instability is eliminated, and much more satisfactory results can be obtained. A rheostat of 25 ohms resistance should be substituted in place of the Federal No. 18 rheostat in the volume control circuit, in order to provide sufficient resistance for cases where the set is to be operated very close to a high-powered station. A Federal No. 22 rheostat will serve very well in this part of the circuit.

The next best suggestion was to employ a common C battery, instead of the three C batteries as described in the May

## JUNE PRIZE WINNERS

In Contest for Improving Best's Super-Heterodyne

1st prize—\$25.00—James R. Kenna, San Francisco, Calif.—Volume Control.

2nd prize—\$15.00—Julian Capwell, Omaha, Neb.—Common "C" battery.

3rd prize—\$10.00—Arnold R. Casper, Philadelphia, Pa.—Cutting out last a.f. amplifier.

Similar prizes are to be awarded each month for a six-months' period, and additional final prizes of \$60, \$40 and \$20 for the best ideas submitted during the entire period.

issue. This common C battery connection is shown in the revised circuit, and should preferably be an Eveready No. 771 C battery, with a special tap taken out at the first negative 1½-volt cell terminal, so that the intermediate frequency amplifiers and the oscillator are provided with 1½ volts negative grid potential. The entire +½-volt battery provides negative grid potential for the first detector tube and the two audio-frequency amplifiers. The battery should be located on the baseboard, in approximately the position now used for the +½-volt C battery in the first detector tube circuit. As the No. 771 battery is not provided with a tap at the 1½-volt point, it will be necessary to scrape away the compound on the top of the battery unit until the 1½-volt terminal is exposed.

The third best suggestion was to incorporate a telephone jack of the four spring variety, so that the last audio-frequency transformer could be entirely eliminated from the circuit when not desired, and this jack is shown in the

circuit diagram on this page. The jack may be a Federal No. 1423-W, or any other good make of jack with the proper spring contacts. The open circuit phone jack already in the set may be placed in multiple with the phone tip jacks, on the output of the last tube, so that a pair of phones employing a plug may be inserted in the last stage, at the same time that the loud speaker is connected to the phone tip jacks.

A LARGE number of questions have been received from readers on the subject of the use of C-301-A or UV-201-A tubes instead of the dry cell tubes. There is no reason why the "A" type tube cannot be used in the circuit, provided the proper sockets are used, and a filament rheostat capable of carrying 2 amperes is provided. The use of "A" tubes will of course require a storage battery, as eight tubes will draw .25 amperes each, making the operation of the set from dry cells very uneconomical. The same values for the B and C batteries should be used, and the B battery voltage applied to the intermediate frequency amplifier should not exceed 45 volts under any circumstances. The intermediate frequency amplifier will not give any greater amplification with the "A" tubes than with the C-299 tubes, for, although the mutual conductance of the "A" tube is higher than the C-299, the intermediate frequency transformers work best with a tube of higher impedance than the "A" tube, and hence the gain obtained by the use of the storage battery tube will be offset by reflection losses in the output circuit of each intermediate frequency amplifier tube.

The writer has received perhaps fifty letters asking about the use of an antenna with the Super-Heterodyne re-

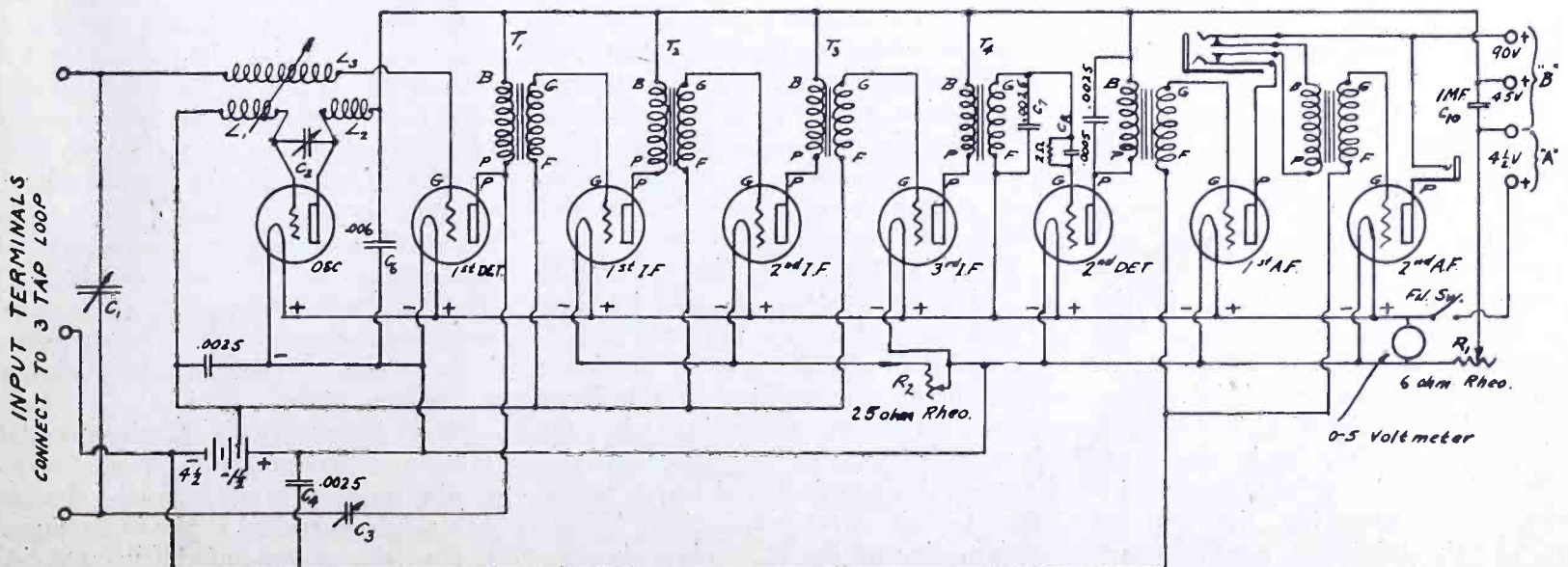

Circuit Diagram for Best's 45,000-Cycle Super-Heterodyne with June Prize-Winning Suggestions Incorporated

ceiver. Except in rural districts, the addition of an antenna tuner in place of the loop will result in such an increase of noise, man-made static, from power lines, street cars, etc., and spark interference, that any increase in signal strength will be of no use, as the noise will drown it out. Fig. 2 shows the best circuit for the antenna connection, however, for there are many who do not care to build the loop and already have an antenna. The coupler shown must be of the 180-degree type to obtain best selectivity.

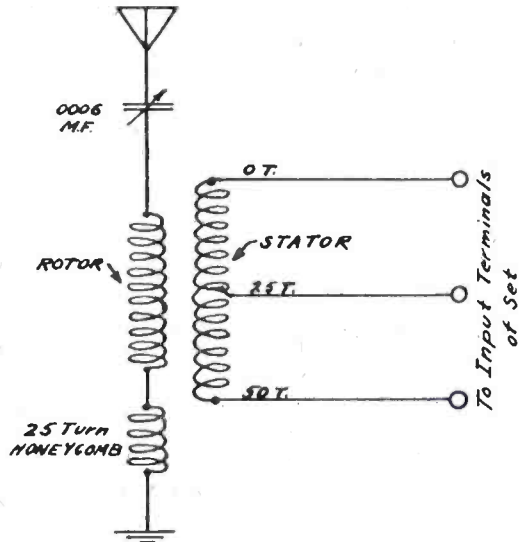

Antenna Tuner for Best's 45,000-Cycle Super-Heterodyne

The most convenient coupler to use is the same set of coils as are used in the oscillatory circuit in the Super-Heterodyne receiver, the Remler No. 620 oscillator coupler being the coil recommended in the original article. The rotor should be connected to the antenna circuit, and should be placed in series with a 75-turn honeycomb coil and a 23-plate air condenser. The stator windings are connected to the input binding posts on the set, the center taps of the oscillator coil being strapped together and connected to the center binding post on the set, and the two outside terminals of the coil being connected to the top and bottom binding posts on the set. If the reader already has a good coupler on hand, the stator will probably have 50 turns, so that the tap at the 25th turn should be connected to the center binding post on the input end of the set, and the outside terminals will go to the other two input binding posts. In cities where there are many broadcasting stations, it might be desirable to unwind some of the turns from the rotor, and increase the size of the load coil. In this case, a total of 10 turns in the rotor would be sufficient and the load coil should be increased to 100 turns, an unmounted honeycomb coil being appropriate. If the oscillator-coupler is used, the rotor will not have to be unwound, as it already has the right amount of inductance. In operating the antenna tuner, use the minimum possible coupling, and avoid overloading the inter-

mediate frequency amplifiers, as distortion will surely result if too much energy from the antenna is permitted to pass into the first detector.

Many readers have written that they cannot afford to buy the complete set of parts recommended for building the set, and would like to wind their own transformers to cut down the cost. Data were given in the June issue of RADIO, for winding the intermediate frequency transformers, and the following specifications are for a home-made tuned circuit transformer, to be used in place of the Remler No. 610 transformer, when desired: A spool of good seasoned hardwood should be turned on a lathe, so that it has flanges of  $\frac{1}{4}$ -in. width, a diameter of  $2\frac{1}{2}$  in., a hub of 1 in. and a slot  $\frac{1}{2}$  in. in diameter. On this spool wind 250 turns of No. 30 D.C.C. wire, in a hap-hazard manner. Place over this winding, which is the primary, a piece of insulating paper. Over this paper wind 1800 turns of No. 36 single cotton or single silk wire, for the secondary coil. This transformer differs somewhat from the Remler No. 610 tuned transformer, and requires a condenser of .005 M. F. bridged across the primary winding, instead of the .00025 M. F. condenser bridged across the secondary winding, as is done in the case of the Remler transformer. It is very important to be sure that a fixed mica condenser of .005 M. F. is shunted across the primary circuit, and that no fixed condenser is bridged across the secondary winding, as the transformer will not function properly unless this is done. The four leads of the transformer may be connected to convenient terminals on the edge of the wooden spool.

## CRYSTAL vs. VACUUM TUBE

By JEROME SNYDER

SOMEWHERE, sometime, somebody made the statement that the crystal detector was the most perfect detector for quality of reproduction, and that, therefore, it was superior, from this point of view, to the vacuum tube. Thereafter everybody who wrote an article in which the crystal detector was mentioned did not fail to state in parrot-like fashion that the crystal detector could not be surpassed by any other detector for quality of reproduction. This is a myth, and the object of this article is to explode this myth.

The thing that determines the quality of a detector is what is called its "law of response," that is, is the ratio of output signal of the detector to the input signal or to some power of the input signal. This is determined by the characteristic curve of the detector. Suppose that we had a detector whose characteristic curve were given by the straight line of Fig. 1. Then the output signal of the detector would always

be directly proportional to the input signal, the output would be an exact copy of the input and we would have a per-

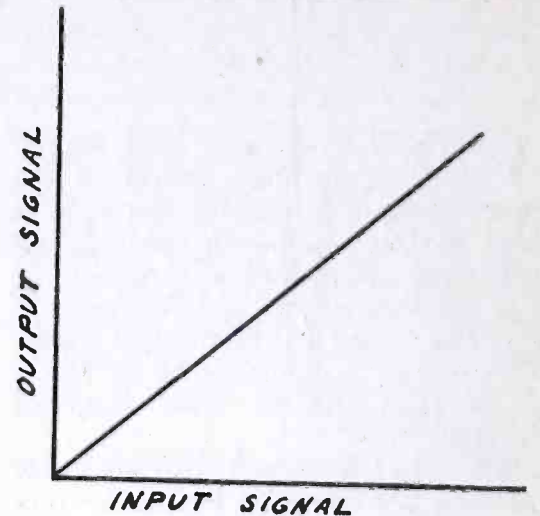

Fig. 1. Ideal Detector Characteristic for No Distortion

fect detector, which gives distortionless response. This is the ideal which we should aim for.

But we have no such thing. The vacuum tube has a curved characteristic which is the very well known one in Fig. 2. The curve itself shows that the plate

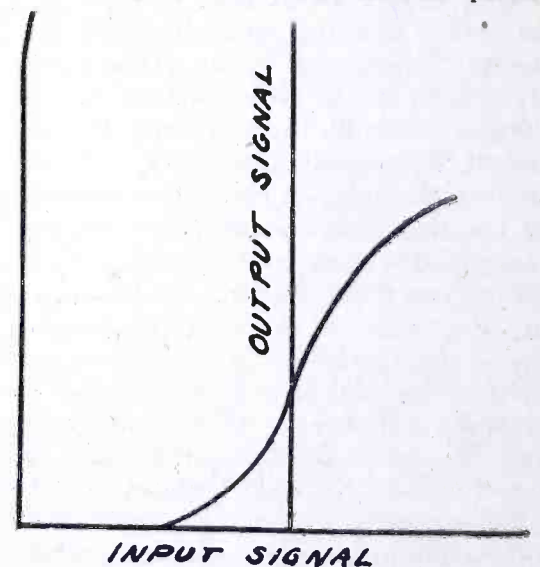

Fig. 2. Vacuum Tube Detector Characteristic

current is not directly proportional to the first power of the input voltage. In fact it has been shown that the plate current of a detector tube is proportional to the square of the input signal voltage. It is from this that the tube has received the name of the "square law" detector. As a result the output signal is not an exact copy of the input signal. The effect of the square law is to introduce a certain amount of distortion by introducing the second harmonic terms. That is, if we are hearing a soprano singing a thousand-cycle note, we not only hear the thousand-cycle note, but also a two thousand-cycle note which is not present in her voice. However, this distortion is not very great.

Well, how about the fabulous crystal? Has it a straight line characteristic? Is the response from a crystal detector directly proportional to the input signal? Let us look at some of the characteristic

Continued on page 66

# Finding the Natural Period of the Antenna

By C. H. Campbell, Radio 1IV

*Directions are here given for making a simple vacuum tube oscillating circuit which may be tuned to resonance with an antenna and then compared with a wavemeter. From this the natural period of the antenna may be easily calculated.*

WITH the present controversy as to whether an antenna should be operated above or below the fundamental, it is important that the amateur know the natural period of his antenna. Some time ago there was published in several books and magazines a chart from which it was supposed to be possible to determine the natural period of antennas of different dimensions. Such calculations are worthless. There are too many factors which alter the constants of an antenna to attempt to standardize its measurements in this manner. The only thing to do is to get an accurate wavemeter and measure it.

Some way of producing oscillations is necessary, such as connecting a spark coil or buzzer in series with the aerial and ground. A crystal detector and head phone are connected to the wavemeter and the condenser scale on the wavemeter is turned until maximum signal strength is heard in the phones. While it sounds simple enough, the wave emitted by such an arrangement is so broad that it is very difficult to find the exact point of resonance, and usually an inaccurate reading is the result.

It is much better to use a vacuum tube oscillator or driver to generate the oscillations. This method is widely used in laboratories for measuring the wavelength of circuits, capacity, inductance, calibrating wavemeters, condensers, etc. A simple oscillator is shown in Fig. 1, and all the parts can be found

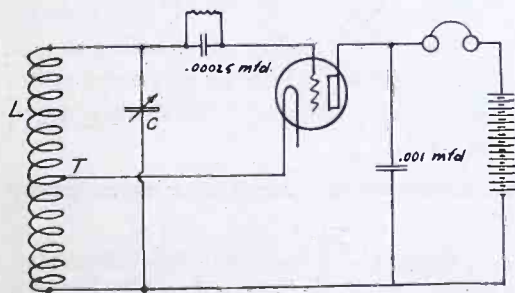

Fig. 1. Simple Oscillating Circuit

in the average amateur station. Even the regular receiving tube has sufficient power for this purpose. A low reading milliammeter is usually used in the plate circuit instead of the head phones to indicate resonance, but, as the average amateur is not likely to have one, no difficulty will be experienced in finding a well-defined peak using the phones.

When wired as shown, the circuit will oscillate at a frequency determined by the inductance  $L$  and the capacity  $C$ , and their values will depend upon the fre-

quencies to be measured. If the maximum capacity of  $C$  is .0005 mfd. and inductance consisting of 18 turns of No. 18 DCC magnet wire wound on a tube 4 in. in diameter, will permit a wavelength range from about 100 to 300 meters to be covered. The tap  $T$  is taken off at the ninth turn.

To measure the natural period of an antenna, make a small single-turn loop in the ground lead and place the driver so that  $L$  is in inductive relation to the loop. Light the tube and, if it is oscillating, the familiar faint hissing or steaming noise will be heard in the head phones. With the coupling between the circuits fairly close, turn the condenser  $C$  until there is a click in the phones. The antenna circuit is now roughly tuned to the same wave as the driver and has stopped it from oscillating. Turn the condenser a little further and another click will be heard in the phones and the driver will start oscillating again. Loosen the coupling and the points where the clicks are heard will move closer together. Finally, a single click will be heard right at the resonance point. Without disturbing the setting of the oscillator, remove the antenna circuit and substitute the wavemeter for it. By turning the wavemeter condenser, proceed as before to find the resonance peak. Since the oscillator is tuned to the same wave as the antenna circuit, and the wavemeter is tuned to the same wave as the oscillator, the wavemeter reading is the natural period of the antenna.

The capacity of the antenna can be easily calculated by connecting a condenser of known capacity in series with the aerial and ground and a wavelength reading taken as before.

$$\text{Then } C = \frac{\lambda^2 - \lambda_1^2}{\lambda_1^2} \times C_1$$

Where  $C$  = Capacity of antenna in microfarads

$C_1$  = Capacity of series condenser.

$\lambda$  = Natural period of antenna.

$\lambda_1$  = Wavelength of antenna with  $C_1$  in series.

Similarly the inductance of the antenna can be found by using an inductance of known value in place of the condenser and another reading taken.

$$\text{Then } L = \frac{\lambda^2}{\lambda_1^2 - \lambda^2} \times L_1$$

Where  $L$  = Inductance of antenna in centimeters

$L_1$  = Value of known inductance.

$\lambda$  = Natural period of antenna.

$\lambda_1$  = Wavelength of antenna with  $L_1$  in series.

## LETTERS FROM A "LID"

Still at Boston.

Hello to All the Bunch:

Last night, fellows, I meets the swell-est little frow, as the Dutch facetiously calls the sex. Shes little and small, with trusting eyes, that rouses in a man's soul the protector feeling, and—

But I promises to keep everything cronilogikally stated so I better go back to how I makes that Inspector feel like a fellow what has to say back a shame-faced QRS to a perfect 25 per fist.

I pulls all the switches out careless like, meanwhile saying over my shoulder, "Shes all to the plug's jack, Inspector."

I gives him credit for being noticing, for he sees the gaps is warm, but Oh what a spent coil otherwise.

"You been sending with the aerial in?" he interrogates haughtily.

Well now fellows, what kind of 40 times a dumb-gong, do you think he has me copied for. I sometimes wonder yet what he figures I thinks the aerial is gone to all the trouble to be strung up there for. For a ornament?

Its such a easy one, I curl my lip and kind of smile, and say ironically: "Of course not."

He gets me alright, for hes as silent as the inside of a empty coffin.

Then he sees how many volts in the Batts by how they flocks to the meter for inspection. Evidently enough shows up, for he don't utter a word in reply.

To tip it all off fellows, he asks me suspicious like to see my license. When I triumphantly presents the old meal ticket, and you fellows know how many months I lives on corn-beef-hash training for it, he don't believe me yet, and takes the number like he is some St. car Conductor Inspector. I'll bet he kicks himself plenty when he gets back to the Inspector's headquarters and finds everything orderly.

The time soon comes to start, and after neatly winding up the ropes we is tied up by on giant iron spools for that purpose, we're off in a cloud of wake.

Fellows, you all know its diametrick to my disposition to boast, but I'm simply urged to laud the meals on board

Continued on page 60

# Vacuum Tube Data

By G. M. Best

Since the original publication of a table on vacuum tube data in these columns there have been so many changes in the tube situation as to make desirable a complete revision and republication. This text explains the several table headings and the meaning of mutual conductance.

**C**HARACTERISTICS are here tabulated for the principal vacuum tubes used in broadcast and amateur receivers, and in amateur transmitting stations. The tubes are grouped by manufacturers and the data represents the best information available from the manufacturers' specifications.

The proper filament current is given in amperes for normal operation, at the voltage given. The battery supplying the filament is usually operated at a slightly higher voltage than that given in the table, in order that variations in the battery voltage may be taken care of with a rheostat. The normal plate voltage is that above which the tubes should not be operated, especially those with very small elements, placed close together.

The plate current flow to be expected with the corresponding plate battery is given in milliamperes.

The proper *C* battery or negative grid voltage depends upon the plate voltage and the position of the tube in the circuit. In a multi-stage amplifier, the first stage generally operates with a small negative grid voltage, as the alternating current input is small, and the last or power stage requires a large negative grid potential, with corresponding higher plate voltage. The usual method of obtaining the negative grid voltage is to employ a dry cell battery made up of flashlight cells, although the voltage drop across a potentiometer resistance placed in the filament circuit is occasionally used to obtain the same result. If the tube is operated with no negative grid potential, which fact, sad to say, is true in more than half the receiving sets sold to the unsuspecting public today, the plate current will be

much greater with a given plate voltage, and the tube will not operate without introducing considerable distortion, particularly where loud speaker volume is required. The drain on the *B* battery where the *C* battery is omitted in a multi-tube outfit is surprisingly large, and will soon run down one of the ordinary block type *B* batteries. In the case of the detector tube, it is best to connect the grid return to the positive side of the filament, for the best detector action is generally obtained with the grid slightly positive with respect to the filament.

The output impedance of the tube is given in ohms. This factor is particularly useful in selecting the right kind of inter-tube transformer or headphones, so that the impedance of the tube will be the same as the input impedance of the transformer or phones. If a high impedance tube is connected to a low impedance transformer, or vice versa, a large portion of the output energy of the tube will be dissipated in reflection losses and only a small part of the generated voltage will actually be impressed upon the next tube in the circuit.

The amplification constant gives an idea of the voltage amplification to be obtained from the tube.

The mutual conductance value for each tube is given in micromhos. The mho is the unit of conductance, in electrical parlance, and represents the reverse of resistance, being the ability of an electrical circuit to conduct electricity rather than to resist it. The micromho is the millionth part of the mho, and is used for convenience in figuring. The mutual conductance of a vacuum tube is a measure of the effect of the grid potential upon the plate current. All

vacuum tube circuits involve the use of alternating current variations in the grid circuit, which control the plate current flow, so that the mutual conductance value has become a good method of rating the excellence of the tube as an oscillator, amplifier or detector. It is most desirable to have the mutual conductance of the tube as high as possible, as small variations in the alternating current input will mean relatively large variations in the output circuit. The mutual conductance of any vacuum tube may be computed from the plate impedance and the amplification constant, by the use of the following formula, where  $G_m$  = the mutual conductance in micromhos,  $\mu$  = the amplification constant, and  $Z$  = the plate to filament impedance.

$$G_m = \frac{\mu \times 1,000,000}{Z}$$

Some of the Western Electric tubes are not sold except with apparatus manufactured by that company. The 216-A tube is used in the 10-A and 14-A loud speaking outfits and cannot be purchased separately except for replacement purposes. The 203-B tube is most generally known as the VT-1, a development of the Great War, and used by both the army and navy very extensively. A large number of these tubes have been sold by the army as surplus equipment, and the same is true of the 205-B tube, which is known in the army as the VT-2 and in the navy as the CW-936. The tubes manufactured by the General Electric and Westinghouse Companies are sold either by E. T. Cunningham, Inc., or the Radio Corporation of America, the only difference in the tubes being the code numbers, which are given in the table.

Code No.	Manufacturer	Filament		Normal Plate		Proper <i>C</i> Battery	Output Impedance	Amplification Constant	Mutual Conductance
		Current	Voltage	Current	Voltage				
C-299 or U V-199	General Electric or Westinghouse	.06	3.0	1-4.0	45-90	1.5-4.5	21,000-17,000	6.5	310-380
C-300 or U V-200	"	1.0	5.0	0.25-1	18-25		10,000		
C-301-A or U V-201-A	"	.25	5.0	1.2-8	45-120	1.5-9	20,000-12,000	7.5	375-625
C-302 or U V-202	"	2.35	7.5	45	350	22	4,000	7.5	1875
C-303 or U V-203	"	6.5	10	150	1000	35	3,300	10	3000
C-304 or U V-204	"	14.75	11	250	2000	55	3,000	25	8300
C-11, C-12, or W D-11, W D-12	Westinghouse	.25	1.2	0.7-2.0	45-90	1.5-4.5	20,000-17,000	6	300-350
D V-2	De Forest	.26	4.5	1-5	45-90	1.5-4.5	20,000-13,000	6.5	320-500
D V-3	"	.07	3.0	8-3.5	45-80	1.5-4.5	21,000-17,000	6	280-350
203-B or V T-1	Western Electric	1.1	2.5	.8	22 as det.		22,000		
				2.0	45 as ampl.	1.5	15,000	6.5	400
205-B or V T-2	"	1.35	7	8-40	120-350	9-22	6,000-4,000	7	1150-1500
215-A	"	.25	1.1	.7	22 or 45	1.5	25,000	6.5	260
216-A	"	1.0	6	.7	120	9	6,000	6	1000

# QUERIES & REPLIES

## ON C.W. PRACTICE

BY  
**Gerald M. Best**  
 TECHNICAL ADVISOR



Questions submitted for answer in this department should be typewritten or in ink, written on one side of the paper. All answers of general interest will be published. Readers are invited to use this service without charge, except that 25c per question should be forwarded when personal answer by mail is wanted.

Please show me how to add one stage of radio-frequency amplification to my set, which consists of a variocoupler, air condenser, C-300 tube and phones. My set howls on certain adjustments of the coupler. What is the cause of it?—W. J. C., Saratoga, Calif.

The circuit for adding one stage of radio amplification is shown in Fig. 1. Probably

tubes with small elements. Successful neutrodyne sets using the small tubes have been constructed, however, and I can see no reason why you should not have good success with C-299 tubes.

How can one stage of radio-frequency amplification be added to the Cockaday four-circuit receiver? Is there any difference in the efficiency of coils for this

wire. A condenser of .002 M. F. is generally bridged across the primary of the first audio-frequency transformer, in a multi-stage amplifier, to by-pass the radio-frequency in the detector circuit. It will also resonate the transformer to a particular frequency, generally slightly above the ordinary voice range. However, a condenser, even as small as .002 M. F., bridged across the secondary, will resonate the transformer at a frequency well within the voice band, and will surely create distortion in the output of the next tube. It is very undesirable to shunt the secondary with a condenser, unless the transformer is so poor that it requires a condenser to flatten out its frequency characteristic, in which case it would be advisable to get a better transformer rather than resort to the shunt capacity method. I would not expect you to notice much difference when you remove one tube from a push-pull amplifier, unless you were amplifying a large amount of power. The principal purpose of the push-pull amplifier is to obtain better quality with large volume, than is possible with one tube, and the real difference between the two is evident only when the input to the push-pull stage exceeds that which is ordinarily used with one tube.

Please tell me which set would be more advisable to build: The improved Armstrong super-heterodyne using the second harmonic principle, or the 45,000-cycle super-heterodyne described in May RADIO.—G. T., New York City.

From the standpoint of complete constructional data, I would advise you to build the set described in May RADIO. Parts for the second harmonic circuit are not available, and constructional data is not complete enough at this time to enable you to build a satisfactory set.

Please publish a circuit for a three-tube neutrodyne not employing audio-frequency amplification. — C. H. E., Rochester, Pa.

The circuit accompanying Mr. Munzig's article on Page 24 of May RADIO shows a complete Neutrodyne circuit. The audio-frequency stages may be omitted by cutting out the audio-frequency transformers and the

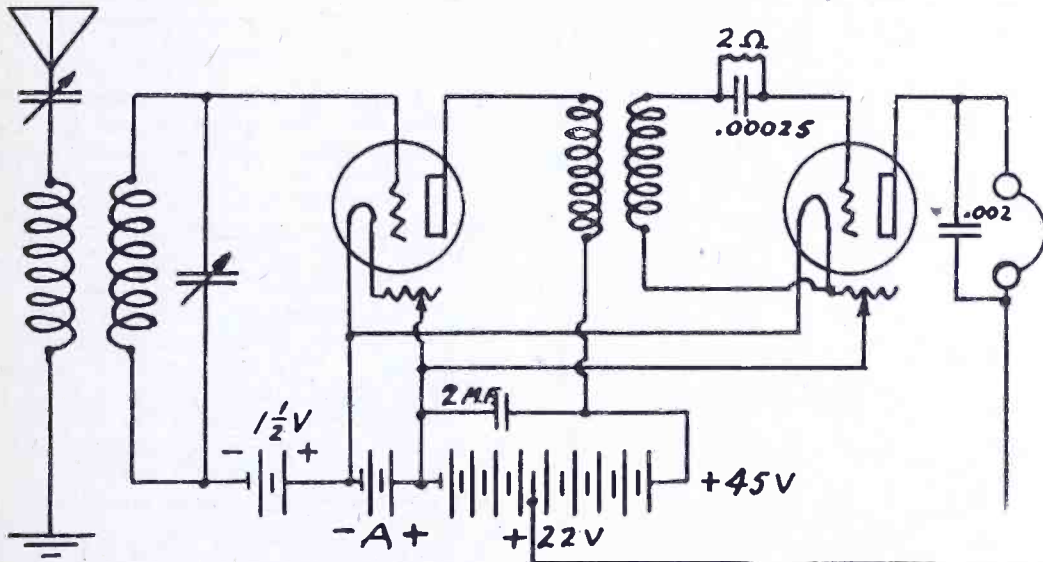

Fig. 1. One Stage of R. F. with Detector

you have too close a coupling between your tickler coil and the stator of the coupler. With the circuit above you will not be troubled with such noises.

Please publish the circuit for a Neutrodyne set, with two stages of audio-frequency amplification. Can C-299 tubes be used?—H. J. J., Duluth, Minn.

Several circuits on the Neutrodyne have been published, but for the benefit of those readers who may not have seen the circuits, the diagram in Fig. 2 is shown. Many Neutrodyne manufacturers specify only the "A" type tube in their sets, giving as their reason that they cannot neutralize the dry battery

set wound with cotton or silk-covered wire? Is cardboard tubing for coils likely to be any less efficient than tubes made of bakelite? What is the effect of condensers across the windings of audio-frequency transformers? Either tube of my push-pull amplifier can be lifted out without changing the volume or quality of sound. Can you suggest what may be wrong?—F. B. H., Fallon, Nevada.

An adaption of the Cockaday circuit to a radio-frequency amplifier is shown in Fig. 2, Page 35 of March RADIO. Untreated paper tubing is the finest sort of material to use in winding inductance coils. At the higher frequencies, paper tubing would be the best material, but no difference in effect may be expected from cotton or silk-covered

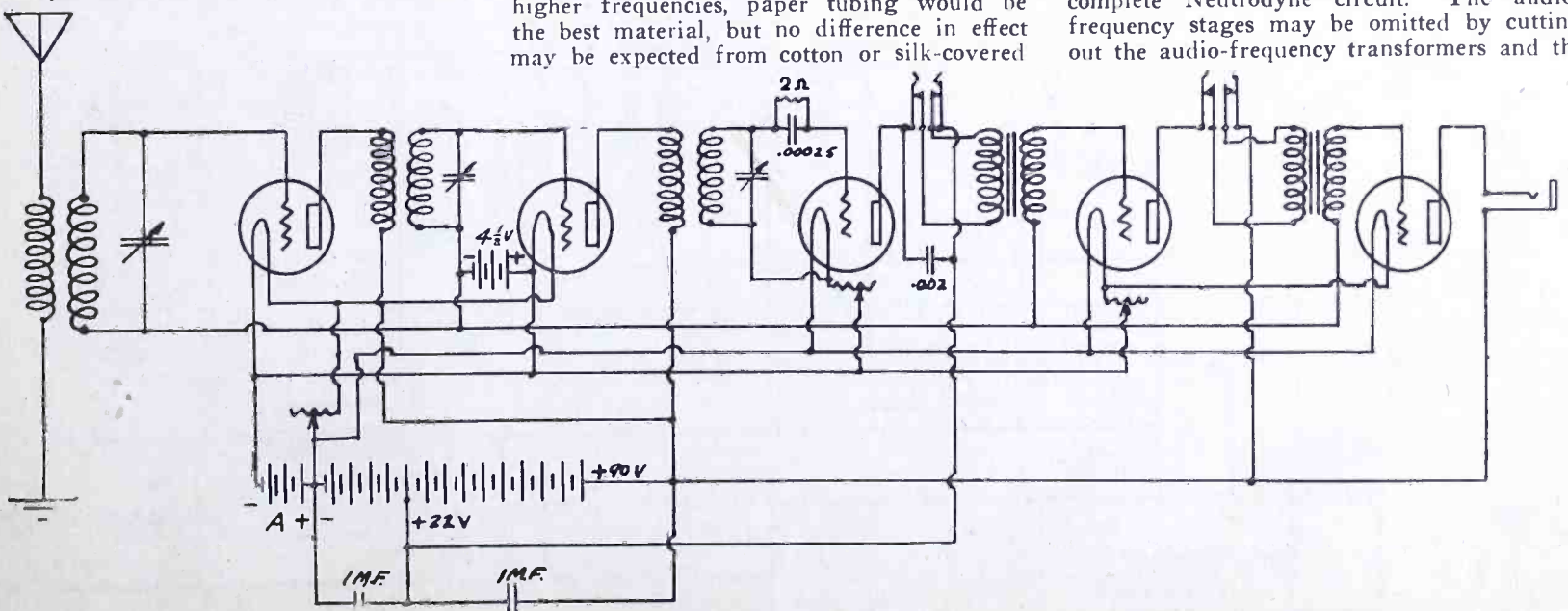

Fig. 2. Neutrodyne Circuit

tubes associated with them. The set described in the article was designed to work with the C-301-A tube.

May 110 volts a.c. be used on the plate of a small transmitting tube? What is the best way for eliminating 60-cycle hum in a radio receiver? Please give data on the construction of an electrolytic rectifier for supplying the primary voltage for a one-inch spark coil, from a 110-volt 60-cycle line.—J. G. S., Columbia, Mo.

It is quite practicable to employ 110 volts a.c. direct from the power line, for a small transmitting tube. If you are troubled with induction from nearby power wiring, especially from the wiring near the receiver, you should shield the inside of the cabinet with either sheet brass or tinplate, connecting the shield to the ground binding post. If one side of the filament circuit is not grounded, this should also be done. A shield placed around the detector tube, and grounded, will often cure the noise trouble. You will not need a rectifier for supplying the primary voltage of the spark coil, if you have a.c. available. The 110-volt power line may be connected directly to the primary of the coil, the vibrator being screwed down so that it will not operate.

Please publish a circuit for a 10-watt C. W. transmitter, using the Colpitts circuit, with two 5-watt tubes as oscillators, two as modulators, and with speech amplifier. A motor generator set is available for plate voltage.—F. J. P., Chicago, Ill.

A circuit such as you describe is shown in Fig. 3. The speech amplifier should be a C-301-A tube, the accompanying choke coil being the primary winding of an ordinary bell-ringing transformer. The audio-frequency transformer should be one of high quality, such as the Federal No. 65, Kellogg 3:1, etc.

Please give me a diagram of a 20-watt C. W. and phone transmitter, using the three-coil Meissner circuit. Is the Meissner circuit as good as the other standard oscillatory circuits?—J. R. C., Wallowa, Oregon.

Except for the oscillator, the circuit is as shown in Fig. 3. The Meissner circuit is not as easy to tune or adjust as the Hartley or Colpitts circuits and is more difficult to construct. I would not advise it for the work you wish to do.

Can one stage of tuned radio-frequency amplification be added to the receiver shown on Page 11 of September RADIO?—J. E. D. B., San Francisco.

The addition of a tuned stage, to the set described by E. M. Sargent in September 1923 RADIO, is shown in Fig. 4. With the addition of the C battery shown, you will probably not need a potentiometer in the circuit.

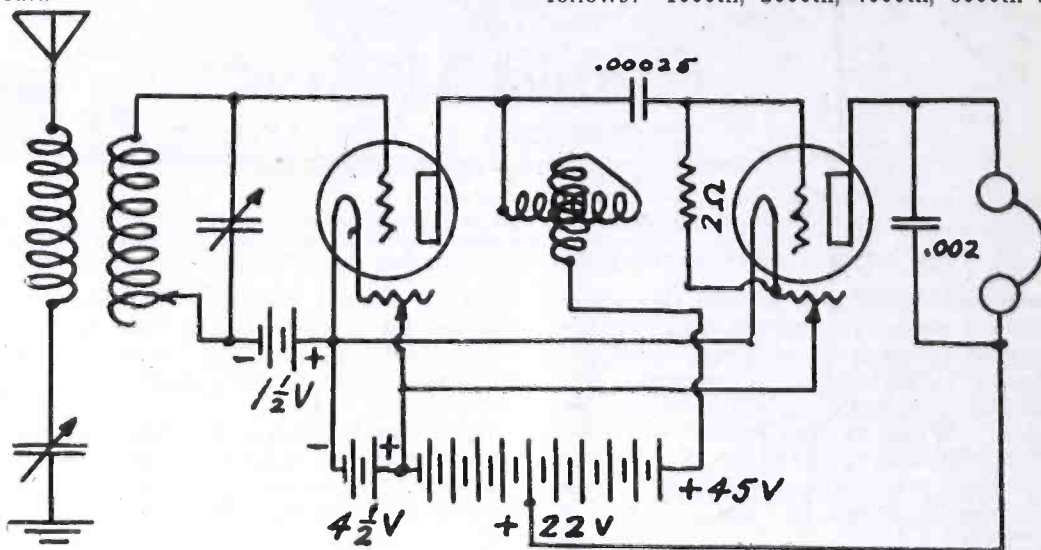

Fig. 4. One Stage R. F. with Two-Circuit Regenerative Circuit

Please tell me what is meant by the symbol shown between grid and plate leads of 2nd detector in the super-heterodyne circuit published in May RADIO.—H. A. F., Tarentum, Pa.

The symbol is the conventional one for the "megohm." The symbol for the ohm is somewhat like the letter "w", but for the megohm it is like the letter "u" turned side down.

In Mr. A. L. Munzig's article in May RADIO, the correct place for the tap on the secondary winding of the tuned radio-frequency transformers was not given. Please publish the necessary correction.—G. F. L., Jr., Corona, Calif.

A tap should be brought out at the 15th turn in the 55-turn secondary coil.

I am so unfortunate as to have 25-cycle 110-volt current in my home. Please give me the specifications for a C. W. transformer having a 110-volt primary, 10-volt filament secondary and 2000-volt plate winding, with center tap at 1000 volts, and extra taps at 500 and 750 volts, each side of the center tap. Will this transformer carry one 50-watt tube? Please give core measurements.—S. W. F., Buffalo, N. Y.

The core should be made up of silicon steel pieces 1 1/2 in. wide and 6 in. long, piled so as to form a square window 2 in. in height. This will give a cross sectional area of 3sq. in. For the primary wind 440 turns of No. 16 D.C.C. wire, on one leg of

the core. For the low voltage secondary, wind 40 turns of No. 14 D.C.C. wire, with center tap at the 20th turn. The high voltage secondary will require 8000 turns of No. 32 D.C.C. or enameled wire, with taps as follows: 1000th, 2000th, 4000th, 6000th and

7000th turns. The filament secondary may be wound over the primary, and the high voltage secondary should be wound on the other leg of the core. The transformer will carry at least two 50-watt tubes.

What causes the peculiar color inside the glass of the C-299 tubes? If a tube burns out, can the wires be tapped together and welded by a strong current? Can you inform me if refilled tubes are any good. I filed the rod of a 23-plate condenser and did not smooth it. I forced the dial on the shaft and am unable to get it off. Can you offer a suggestion?—J. W. C., Los Angeles, Calif.

The coloring on the inside of the glass is caused by a chemical process during the pumping of the air from the tube, in order that the vacuum will be more perfect. I doubt if you can ever repair the filament of a vacuum tube in the same manner that an electric light globe is sometimes repaired, by tapping the tube, with the filament voltage turned on. Refilled tubes are usually very uneconomical of filament current, as the filament material used in the repair work is not the same as that used by the manufacturer, and consumes more current. Many imitations of standard tubes are on the market, and in some cases the filament current is 500 per cent over the filament consumption of the real article, so that it is always best to test the tube with an ammeter, whether it is a new tube, or a refilled one, in order that you can be sure of the facts.

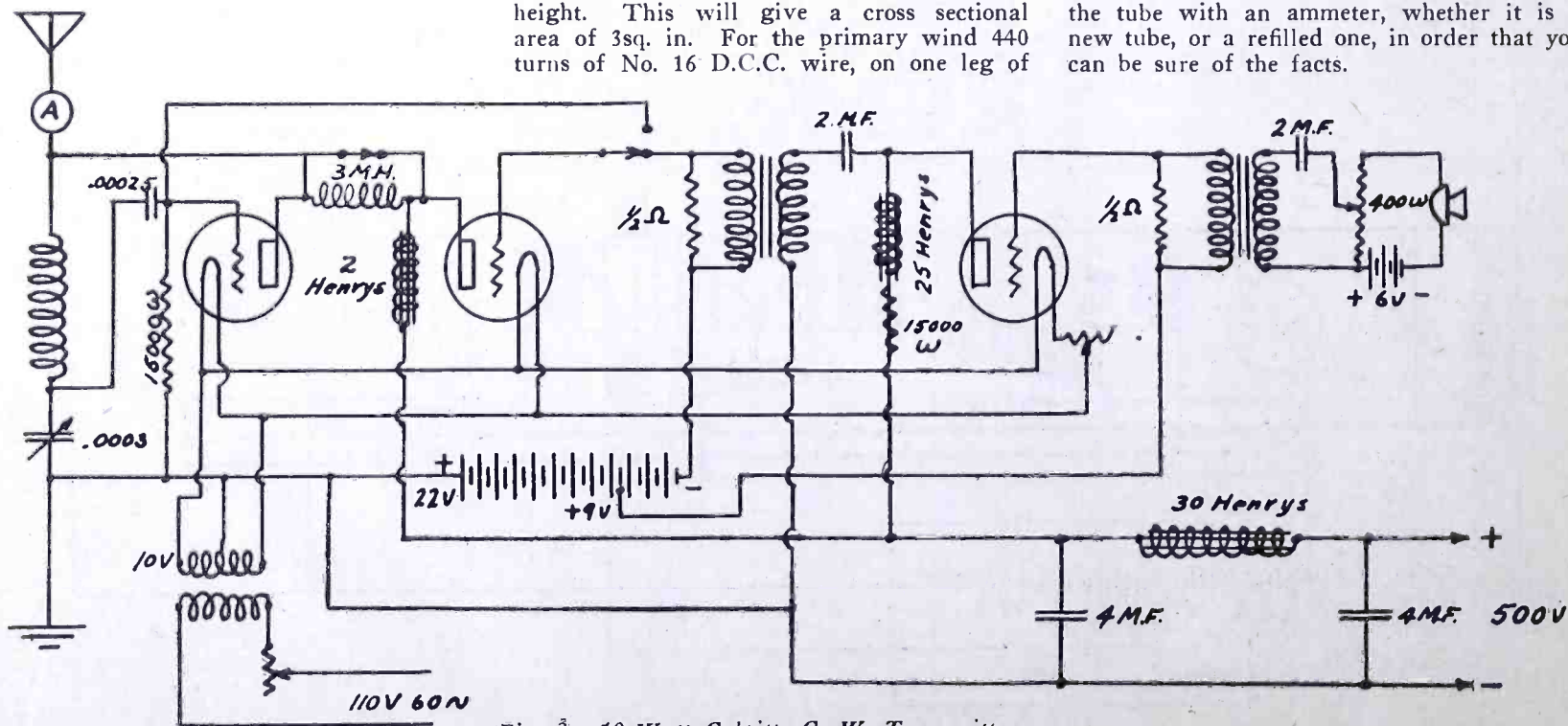

Fig. 3. 10-Watt Colpitts C. W. Transmitter



# LETTERS TO THE EDITOR

## Improving the Single Circuit

Sir: After considerable experiment I have found an improvement for a single-circuit set so as to give greater volume and distance. It consists of the addition of two small spiderweb coils wound in the same direction, as shown in the diagram, to form a double feed-back. Each coil consists of 20 turns of No. 24 d.c.c. wire placed about 4 in. apart.

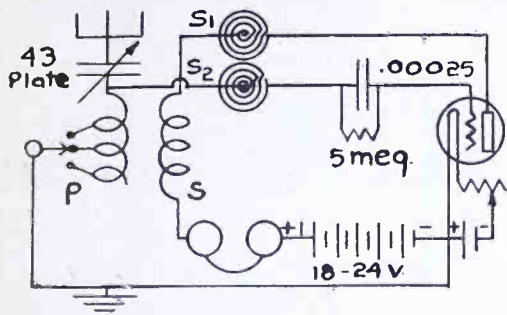

Crawford Circuit

This set works well with from 18 to 24 volts on the plate. Verniers on the aerial condenser and the rheostat make it very selective. There is no body capacity effect. An 11-plate variable condenser shunted across the tickler is a great advantage.

With a 3-ft. loop and one vacuum tube I have heard KSD, WOR, WGY, KHJ and KFI. I will be glad to answer any questions regarding it.  
Box 312. W. M. CRAWFORD.  
Artesia, N. M.

## A Low Power Record

Sir: The following is what I believe to be a new low power two-way record for over-land transmission during summer radio conditions, and thought the gang might be interested in a report of it, which took place between 7ACI at Butte, Montana, and 6BUH at Salt Lake City, Utah.

On the night of May 10, at 11:08 P.M., 7ACI answered my CQ for north, and, after I had given him my north-bound traffic, he came back, "U vy QSA 25 ft fm fones on 1 step." But, when I came back again it was with one tube, for the other went "west" as I lighted the filaments. He reports that the audibility only "decreased very slightly," although the antenna current went to about two-thirds normal. It struck me that all was set for a low power test, so it started right there. I cut the filament down to 6.9 volts, input was then 30 watts. He reported me still very QSA.

7ACI was very QSA here all the time with 42 watts input to one 5-watt tube. He came back and dropped plate power to 25 mills at 225 volts and was readable here except for QSS. That was 5.6 watts input and over 350 miles of mountains.

I came back and further reduced power to 11 watts and still QSA on 7ACI's low loss. During the same transmission I took one side of the rectifier off, which gave half rectified a.c. at something below 300 volts. With this "stuff" going into the plate, it showed just 12 mills, which is 3.6 watts, and the antenna ammeter barely wiggled. 7ACI came back "still readable, but much weaker." That was 350 miles with 3.6 watts input, or 92.22 miles per watt, and over land.

When he came back he further reduced power until at 225 volts only 18 mills were going into the set. That is 4 watts input, or 87.5 miles per watt. 6.1 volts on the filament, too—F.B. for the tubes. On this power he was still audible here in Salt Lake, although too weak to copy; he did not fade clear out once! With one step audio I could have taken everything complete.

7ACI uses conductively-coupled Hartley and 6BUH uses loose-coupled reversed feed-back circuits.

Now, to close the thing, it looks like this: Distance worked, 350 miles. Power at 6BUH, 3.6 watts. Power at 7ACI, 4 watts. Selah!  
FRANK G. BOWMAN,  
Salt Lake City, Utah. Operator 6BUH.

## Successful Underground Reception

Sir: On May 4th, a group of radio experts experimented with tuning in at the Oregon Caves, situated fifty-one miles from Grants Pass and on the highway from Crescent City to Grants Pass. In the innermost recesses of these caves is a large room called the Ghost Chamber. This room is 40 ft. high by 50 ft. wide, by 520 ft. long. At the base of this chamber the altitude from the sea level is 4,055 ft. The radio set used was the most sensitive 8-tube super-heterodyne available, using the modulation system. The caves at this point are 1600 ft. below the surface and 3300 ft. from the entrance. The caves are situated in a solid ledge of limestone, which is at this time of the year saturated with water.

The first experiments were tried with an aerial, but no results were secured, due to no opportunity for proper grounding within the caves. At 7:25 P.M. a Mu-rad loop aerial was connected. Within three minutes, at 7:28, KGW, the Oregonian, Portland, was picked up. The ball score was heard and music by Olson's Concert Orchestra. Signals were weak on the speaker with good volumes on the head phones. At 8:11 P.M. station CFCN, of Calgary, Canada, was picked up with preaching and choir. They signed off at 8:17. On speaker there was better volume from Calgary than from Portland. At 8:37 we picked up an orchestra which proved to be KPO, San Francisco, very weak on speaker. Heard selections, "Sampson and Delilah" and "My Heart At Thy Sweet Voice." These were weak on the speaker. At 9:22 we picked up KGG, Halleck & Watson Radio Service, at Portland, Oregon, playing Victor records. This came in with more volume than anything previously received. At 9:25 we picked up a station with a woman announcing. It was impossible to receive announcement because of code interference. We thought, judging by the position on the dials, that it was KLX, at Oakland, California. At 9:35 we disconnected the set.

No static could be detected within the caves, but fading was quite noticeable. The experiment was witnessed by the entire party of twenty-eight people, composed of the senior class of the Yreka High School, Yreka, California, chaperones, and Mr. W. J. Virgin of Medford, Oregon. The party, under the leadership of Principal E. C. Browne of Yreka High School, made an extensive exploration of the caves, and the radio experts, Mr. Brice Rohrer, Edson Foulke, Jr., and Mr. Virgin, succeeded in tuning in for the first time under these apparently impossible conditions.

This experiment is unique and the only other of its kind known to the party was the experiment conducted in the Hudson River tunnel. Considering the depth of the caves at the point of experimentation, the above results undoubtedly stand out as a most wonderful accomplishment. The trail into the part of the caves is very irregular, turning at sharp angles and varying in altitude many times before the Ghost Chamber is reached. Water is dripping down in the caves constantly and iron ladders are placed at different points in the trail. These conditions, plus the nature of limestone, would

tend to make reception very difficult. Details of the trip can be secured by writing to Brice Rohrer of Montague or W. J. Virgin of Medford.

The Oregon Caves are rapidly becoming one of the wonders of America. Over 15,000 tourists were guided through them last season and some 25,000 tourists are contemplated for the coming season. The caves are filled with beautiful and grotesque limestone and marble formations, and from two to three hours are taken to go through them. Efficient guides are always at service and a splendid resort has been established to accommodate guests. The caves are reached by a few hours' drive from Grants Pass, Oregon. Further radio experiments are contemplated as soon as different equipment is secured for the experiment. Screening the entrances to the caves is planned in order to discover whether the waves come through the entrance or straight through the limestone.

E. C. BROWNE,  
Yreka, Calif. Principal of the Yreka High School.

Sir: Herewith is a sketch which I think will find favor with your readers who are using the new style Bradleystat with three contacts, and who wish to experiment with the different tubes now on the market. This arrangement permits the use of the 1, 1/2, 1/4, or .06 ampere tubes without rewiring the rheostat for each change of tubes.

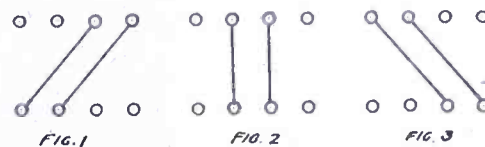
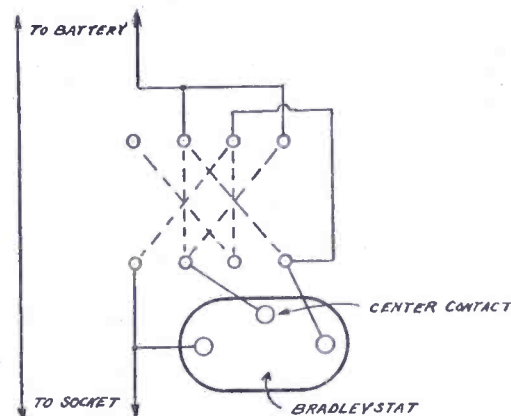

Filament Switch

The only addition necessary is a common series-parallel switch wired as shown in the sketch. The blade positions for each type of tube are obvious.

JOS. HAVLIK.  
Dubuque, Iowa.

## A Good Coil Binder

Sir: A very good insulating fluid and coil binder may be made by dissolving celluloid, such as photographic film, in acetone or acetic ether. If ordinary photographic film is used the emulsion must first be scraped off. This may easily be done by first immersing the film in hot water and then scraping with a dull knife. The plain leader used on motion picture film is not covered with emulsion and as there is usually a quantity of scraps of these leaders around an operating booth it may be had for the asking.

Arthur Hagerman.  
Baker, Oregon.

## RADIO RAILWAY DISPATCHING

**A**N interesting illustration of the application of radio to train dispatching is furnished by the installation of the Detroit, Toledo & Ironton railroad, operated by Henry Ford, which maintains a 500-watt station (WNA) at Springfield, Ohio, a 100-watt station (WJQ) at Jackson, Ohio, and a 1000-watt station (KDEN) at Dearborn, Mich. The first is 300 miles and the second 200 miles from Dearborn. The present capacity of 400 messages per eight-hour day is to be increased to 2000 as a result of the success of the installations, not only for routine business, but also for emergency communication when the wires are down.

All communication is carried on by means of code on wavelengths of 1875, 1934 and 1713 meters respectively. A printer telegraph system also automatically relays messages by wire from Dearborn to the River Rouge station. C. W. is employed for transmission and the heterodyne principle for reception.

The antenna system at Dearborn consists of three 165-ft. towers 450 ft. apart, which at present support two five-wire aerials of seven-strand No. 16 phosphor bronze. More than a ton of copper wire has been sunk in the lake encompassed by the towers to act as a counterpoise.

The station building contains operating, transmitting, battery, furnace and wash rooms. Plate current at 2000 volts is secured by stepping up and rectifying alternating current at 230 volts from the Ford power house. Plans are being made for simultaneous sending and receiving by using loop antennas for reception.

Experimental work is continuously being carried on to increase reliability of operation, the progress so far being the result of two years' work. The pictures indicate the substantiality of the installations.

### Amateur News

6XAD-6ZW is too busy catching 172-lb. tuna and other small fish, in the waters about the famous Catalina Island, off the coast of So. California—to do any radio work. Hence his report is a very small one. G6TM, of London, England, writes to him: "... you are very strong here on but I valve and for a Yank 6 this is wonderful. FB OM". 4AG, New Zealand, reports: "very QSA through severe QRN". Other stations reporting: Can. 2BN, R. K. Coggins, Baltimore, Md.; Wm. F. Miller, Riverhead, Long Island, N. Y.; 8AXF, 9RQ, 9ABC, 9BMD; Wm. Galper, Chicago, Ill.

6EB had a narrow escape in working WNP on April 2, 1924. The former was calling 9DTE at 6:30 P.M. and, immediately after, WNP called 6EB a long time, according to information received from Canadian 3DF of Ontario. It was daylight at both ends and this might have added another record to radio history. Later, on the morning of April 15, which was an excellent night, 6EB copied parts of WNP, who was

swinging badly. He was using 500 volt C. W. and the time was 4:00 A.M. P.S.T. Only ground and 1 step on receiver.

The power at 6EB was a 250-watt G. E. tube running cool for a little over three months. It was copied in every U. S. district during two weeks of operation. Also copied in all provinces of Canada except the 1st and 2nd, in the state of Maine twice (nearly worked 1AUR there, but daylight

broke both up), and worked several eastern stations while full daylight. 6EB was copied several places with no ground and antenna, or detector alone, or tube not oscillating, all about a thousand miles away. The antenna was only 40 feet high (part of new 100-ft. pole) and a lot of the energy must have been going into the house wiring, as the front porch lights would brighten up every time the key was pressed.

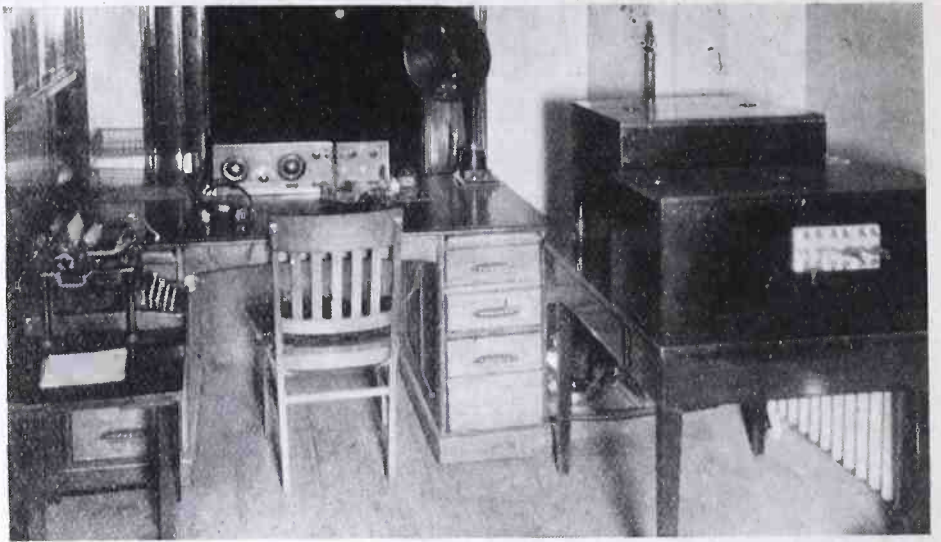

*Operating Room at WNA*



*Transmitting and Rectifying Equipment at KDEN*



*Towers and Building at KDEN*

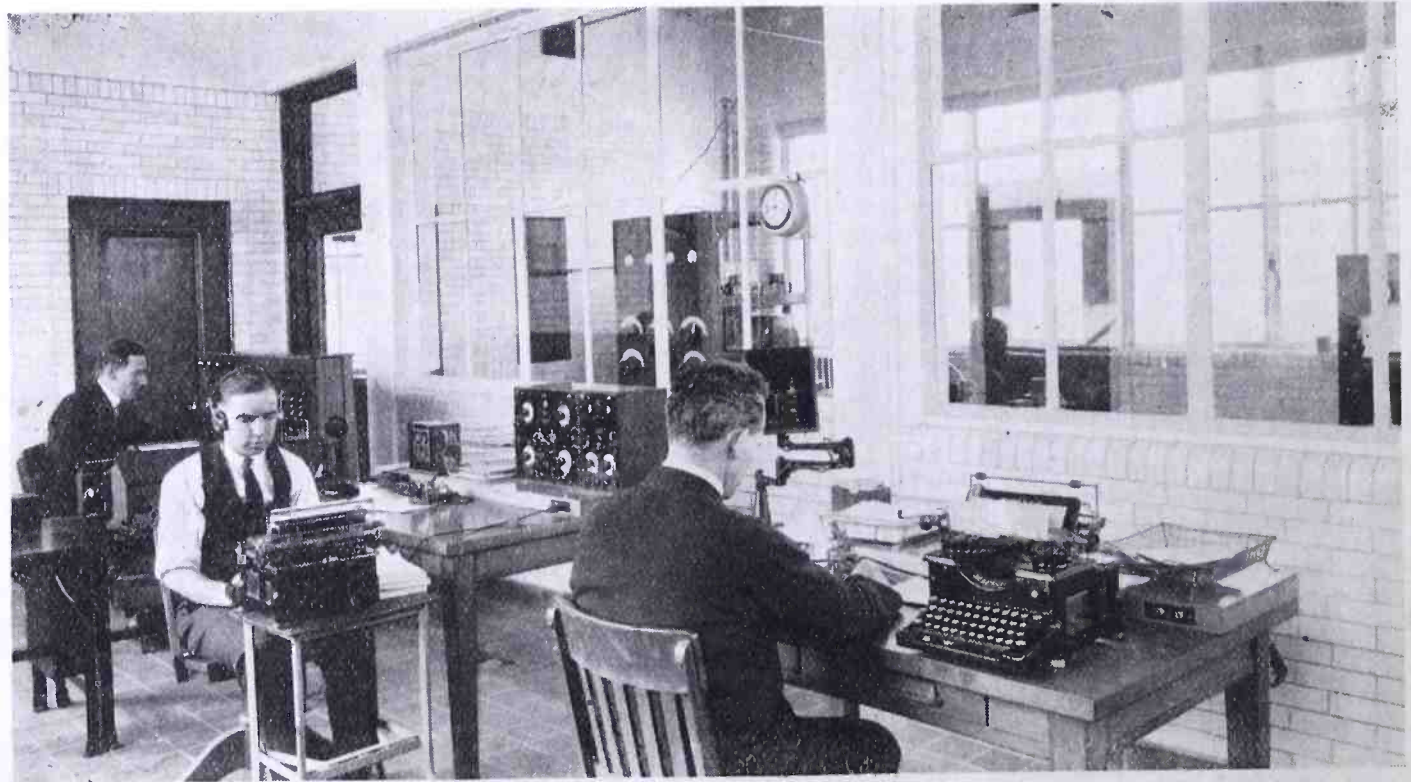

*Operating Room at KDEN*

**RADIO STATION 9AMU**

Station 9AMU is owned and operated by C. Hoover at 210 East State St., Marshalltown, Iowa. The transmitter is equipped to use two UV-203 oscillators in the reversed feed-back circuit. High voltage a.c. is supplied by an Acme 200 watt and a home-made transformer of equal rating, and rectified by two UV-217 kenotrons. The pulsating d.c. is then fed to three 1-mfd. Faradons in shunt. In series with the negative lead is an RCA UP 1654 filter reactor shunted with a W. E. 1/20th mfd. condenser; and an Acme 1 1/2-henry choke. In series with the

lower pointer controls the master filament rheostat in series with the primary of the filament transformer. The set is controlled by a single-key switch, which throws the magnetic antenna change switch and operates the transmitter power supply.

A cage antenna 20 in. in diameter and 45 ft. high and 62 ft. long, with a counterpoise as large as space permits, makes up the outside equipment.

Using one oscillator on 1200 volts at 140 mills, the antenna current is from 5 to 6 amperes. During the past winter the set was in operation but two nights each week, and all districts and Canada were worked. Reports were received from Porto Rico, Cuba, and ships at sea.

The receivers used are: Paragon RA-10, Zenith R-1, and a low loss tuner. Three steps of amplifier are available, though seldom more than detector is used.

**NEWS OF THE AMATEUR OPERATORS**

QRA of 6CTP is D. J. Atherton, Ostrich Farm, Fullerton, Calif.

1BOM is owned and operated by D. L. Darling, 19 Maple St., Greenfield, Mass. The transmitter is on top of Shelburn Mt. three miles from town.

2CHY, W. A. Schudt, Jr., Brooklyn, N. Y., was recently logged by French 8CS. 2CHY uses only one 5-watt tube and has been heard in every district except the seventh.

Call 6CTE has been assigned to Tom Banzhaf, Brookdale, Calif. 50 watts C. W. and phone. All reports appreciated.

Call 3SP has been assigned to Arthur B. Cochrane, 317 Main St., Crisfield, Md., and not 3SJ as reported in the call books.

6BQR operated by J. F. Moss has changed QRA to 1422 Allison Ave., Los Angeles, California, and will soon be on with 50 watts C. W. All reports on signals appreciated.

8XT has been reassigned to Oberlin College, E. W. Thatcher, Oberlin, Ohio, for experimental work on 100-125 meters. Reports from the West Coast on these sigs especially appreciated and all will be answered. 8ZE-8GX 150-220 meters 8XT 100-125 meters.

Radio 7JH, Truman A. Gadwa, Box 5, Pendleton, Oregon, is on the air with 5 watts C. W. and will QSL all cards.

Call 2CV has been assigned to Irving Korenman, 1465 60th St., Brooklyn, N. Y., who wants QSL on his 50 watt C. W.

**ERRATA NOTICE**

WNP was heard by 7DJ, E. L. Sutton, Port Angeles, Wash., on April 13th, and not by 7JD as reported in June RADIO. This error was reported by both stations.

Call 9UC and 9BWF was erroneously listed as 9UC ex 9BWF in May "Calls Heard."

**CALLS HEARD**



Readers are invited to send in lists of calls heard from stations distant 250 miles or more from their own station.

By 6AAN and NALM, Calwa, Calif.

1cmp, 1bnt, 1om, 1bqd, 2rk, 2bqu, 2awf, 3lg, 3zh, 3tb, 4ft, 4eq, 4er, 4my, 5xd, 5alm, 5as, (5az), (5bd), 5aic, 5aaq, 5aaw, 5ql, (6aa), (6aao), 6aam, (6cjl), (6qa), (6zh), (6nb), (6chv), (6gq), (6acl), (6bur), (6asv), (6afa), (6emu), (6enh), (6enl), (6acu), (6lb), (6bpm), (6cbf), (6cju), (6bdt), (6or), (6adb), (6chx), (6hou), (6mp), (6asw), (6afn), (6buh), (6che), (6awe), (6buo), (6cdc), (6kt), (6ego), (6emi), (6eib), (6bls), (6clb), (6bny), (6alo), (6eka), (6ckr), (6dd), (6cd), (6cgd), (6cjd), (6emo), (6jm), (6blq), (6cgw), (6rn), (6ux), (6ky), (6atn), (6brf), (6ahu), (6bwd), (6chz), (6afq), (6afg), (6ainw), (6anp), (6anx), (6anq), (6cfm), (6caq), (6li), (6cgl), (6bd), (6bd), (6ra), (6blz), (6ary), (6agk), (6adt), (6qb), (6buo), (6bih), (6cbw), (6pb), (6blm), (6aoc), (6bij), (6clv), (6hui), (6nx), (6zar), (6ebr), (6bfq), (6ih), (6bbq), (6jj), (6bel), (6ajl), (6aqd), (7fq), (7no), (6fr), (6ft), (6fs), (7aiv), (7aky), (7akh), (7wq), (7aby), (7aha), (7gr), (7vm), (7acf), (7adg), (7gu vry vry qsa), (7ke), (7agz), (7av), (7sy), (7ajt), (7gq), (7hw), (7qd), (7ju), (7aj), (7ut), (7lh), (7aci), (7adm), (8cnl), (8cwr), (8czy), 9ape, (9dun), (9eep), 9bjk, 9bkg, 9dez, (9caa), (9eea), 9mc, 9q, 9hun, 9eak, 9avg. The above were heard on a detector with Baldon fones. Anybody hearing my 5-watt C. W. pse qsl! Tnx in advance. Will skt with any of above.

By 6CDC, Earl Barnett, 3024 44th St., Sacramento, Calif.

3dd, (4my), (5aiu), 5ajj, 5akf, (5az), 5be, (5dc), 5dw, (5lr), 5ql, 5rv, (5zav), (7acm), (7aiv), (7ajq), (7ali), (7av), (7is), (7ke), (7mf), (7mi), (7no), (7vn), (7ws), (7zu), 8ak, (8dae), 8ks, 8tt, 9aau, 9afm, 9ahz, 9amb, 9and, 9aod, (9aoi), (9aom), 9apf, 9azl, 9beu, 9bsp, 9bxq, (9caa), 9edo, 9eds, 9edw, 9cju, (9cju), 9cwi, (9cyg), (9day), 9doe, (9dyi), 9dyn, 9dxr, (9eae), 9eak, 9eam, 9eig, 9eb, 9fm, 9hg, 9ql, 9ss, 9xb. Alaska—(7mn). Can.—4aa, 4dq, (4er), 5ef.

By 8DNF, WM. D. CRAFT, 802 Enterprise Ave., McKeesport, Pa.

(1aal), (1axk), (1bom), (1ctp), (1vc), (1um), (2acs), (2byg), (2cjl), (2cp), (2fo), (2xna), (3ade), (3ape), (3arp), (3ccu), 4af, 4ag, 4by, 4er, 4fz, 4gh, 4io, 4iu, 4og, 4rr, 4sh, 5aac, 5ek, 5lr, 5zr, 6cgw, 6lv, 7co, 8ty spark, 9alc, 9aes, 9alv, 9abl, 9ave, 9boh, 9bye, 9bfb, 9cmf, 9cow, 9cuv, 9cgr, 9cea, 9dnf, 9dro, 9dvw, 9drr. Canadian: (3oh), 3tm, 2bn, 2be, 2dn, 1ar. Wl snd crd to ani above if wanted. Wud appreciate reports on my ac, cw. All crds answered.

By 7AJT, Basin, Wyoming

C. W.: 1avf, 1axn, 1xah, 1xc, 2cfx, 2cqz, 2el, 2sq, 2vh, 2xna, 3aa, 3adb, 3blu, 3cfn, 3dq, 3xir, 5aaq, 5ad, 5ae, 5ald, 5amu, 5ek, 5lp, 5lr, 5ql, 5rg, 5rm, 5sk, 5sp, 5zh, (6aan), 6adb, 6age, 6agk, 6akz, 6alc, 6amn, 6apw, 6aqm, 6arb, 6atn, 6avm, 6bbw, 6bm, (6bqs), 6brf, 6cb, 6cc, 6cdg, 6cfz, 6cgd, 6egg, 6egw, (6che), 6ckh, 6ckr, 6clq, (6cmu), 6dd, 6eb, (6fm), 6ja, 6kj, 6rn, 6vd, 6xbe, 6zu, 7abb, 7aby, (7acf), 7adi, 7ads, 7aex, (7ahs), 7aim, 7aix, 7ald, 7alk, 7bt, 7dz, 7fa, 7fq, 7fs, 7gi, 7go, 7gr, 7iu, 7jh, (7ju), (7ke), 7lg, 7lk, 7lh, 7ma, 7mi, 7no, 7qc, 7ry, 7sh, 7sy, (7ut), 7vn, 7zj, 7zz, 8abx, 8acm, 8ah, 8amr, 8apt, 8arp, 8ate, 8axf, 8bn, 8bpy, 8bsq, 8bum, 8bxx, 8byn, 8cbw, 8cko, 8cnw, 8cpk, 8crw, 8cyi, 8ddx, 8dhs, 8dil, 8djd, 8fc, 8fm, 8hn, 8ig, 8ij, 8pl, 8ry, 8tt, 8ur, 8vt, 8xbe, 8xbh, 8xhp, 8yv, 8zz, 117 nines hrd. Can.—3ws, 4aa, 4bk, 4cb, 4cr, 4dq, 4eo, 4er, 4fm, 4io, 5ah, 5ef, 9cf. Fone: 5akf, (6fm), (7co), 9aj. I. C. W.: 2sq, (6fm), 8apt, 8cfs, 8dmx, 9aec, 9beu, 9cev, 9dlm, 9rc, 9xba. Spk: 9aau (spk?), 9btx, 9es or 9esn?, 9rr. Dalite: 5air, 5aiu, 5amw, 5lg, 5na, 5qi, 6sm, 7ke, 9aby, 9ac, 9atl, 9avv, 9aws, 9bav, 9bcx, 9beu, 9bfp, 9bhd, 9btm, 9btx, 9bx, 9caa, 9ccs, 9cen, 9cju, 9ckj, 9ctg, 9ddf, 9dmv, 9dro, 9dwn, 9dyy, (9dxr), (9ebt), 9ecn, 9ejn, 9iw, 9eky, 9elw. Qrk 7AJT on 10-watt crac? Wl qsl abv if requested.

Continued on page 44

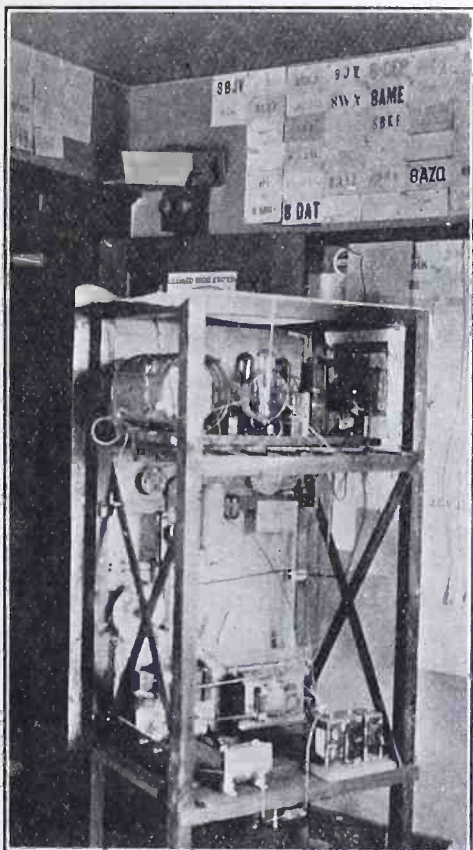

Rear of Transmitter Panel at 9AMU

positive lead is an RCA UP 415 choke and an L 300 honeycomb coil. This constitutes the filter and pure d.c. goes to the plates, as many reports prove. The keying relay is in the grid return, and working simultaneously with it is a filament drop compensating relay.

The layout is mounted behind a 31 by 47-inch panel and is easy of access, or may be moved about by disconnecting only the antenna and counterpoise, and 110-volt leads.

On the panel are: a Weston 0-10 TC radiation meter, a filament voltmeter, and a plate current ammeter and voltmeter. The pointer at the upper right of the panel, when rotated, varies the taps on the grid coil, and when pulled out varies the coupling. The

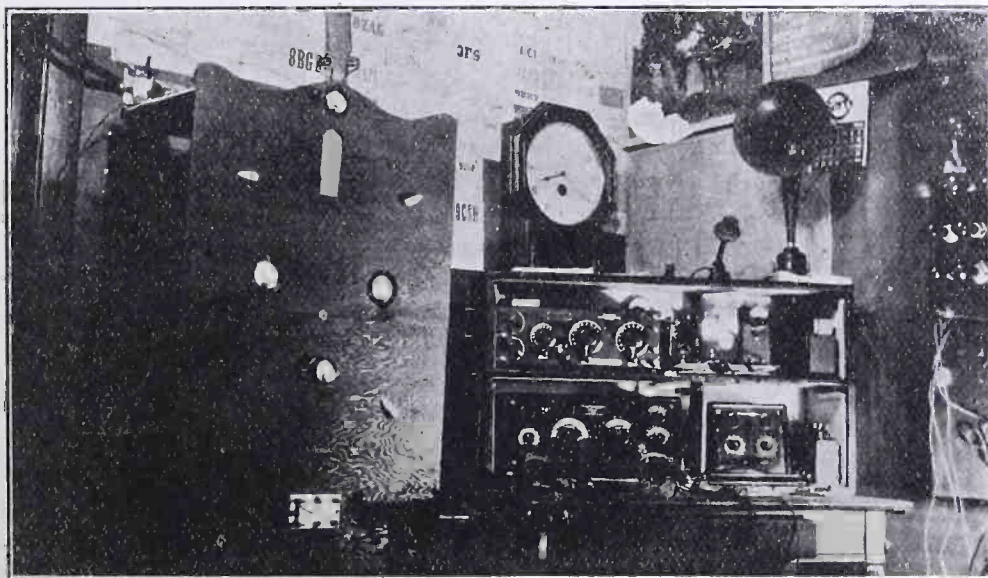

Transmitter Panel and Receiver at 9AMU

# FROM THE RADIO MANUFACTURERS

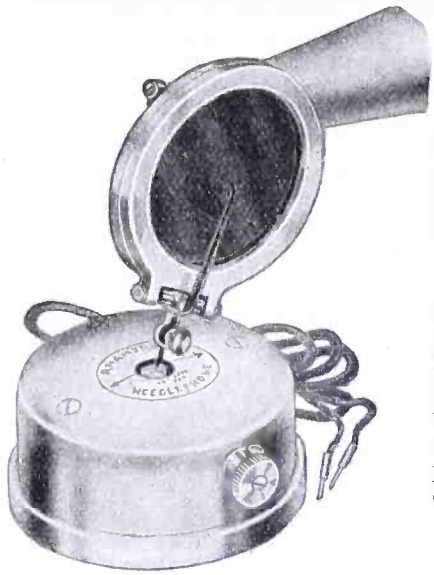
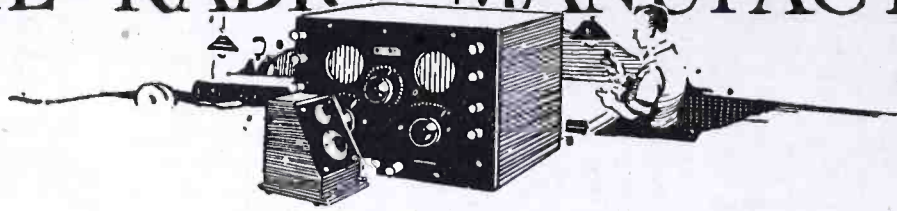

The Rhamstine Needlephone phonograph loud speaker is a new device for utilizing the sound chamber of any standard phonograph except the Edison as a radio reproducer. The phonograph needle is merely rested on it without removing the reproducer. No external battery or special hook-up is required. The cord is attached to the radio set in the same manner as any loud speaker. Perfect sound reproduction is claimed for this device.

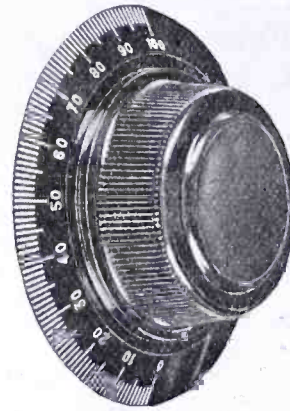

Na-ald Super-De Luxe dial is manufactured in the  $3\frac{7}{8}$ -in. size, and has a large beautifully shaped knob. It is made from black Bakelite with uniform back ribbing and cure. Graduations and numbers are placed on the bevel and are marked with a permanent, brilliant white. The dial is provided with a large positive grip set screw. No special screw driver is required for setting.

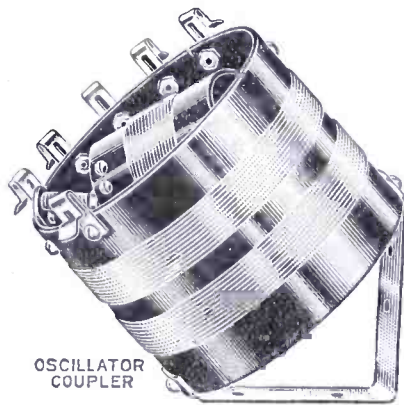

OSCILLATOR  
COUPLER

The New York Coil Company's oscillator coupler is especially designed for use in a super-heterodyne set. The stator is wound of low resistance double silk covered wire on a  $3\frac{3}{4} \times 3$  in. bakelite tube. The rotor is the 180 degree type. All metal parts, including six Fahnestock terminals, are nickel plated.

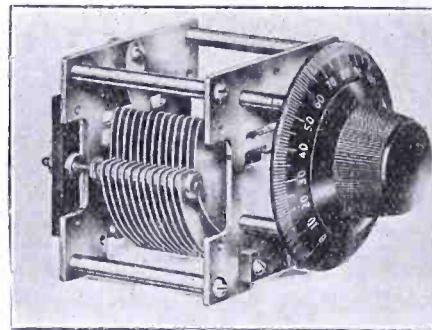

National Perfect Vernier Condensers are made in four sizes with 13, 17, 25 or 43 plates having respective maximum capacities of .00025, .00035, .0005, or .001 mfd. Rough tuning may be accomplished by turning the dial, and fine tuning by turning the knob, one complete revolution of which gives  $1/10$  revolution of the dial. This gives a smooth and even reduction of motion with no back lash. Each unit may be used either for table or panel mounting. Mechanically, it is compact, rugged and of the finest workmanship. Electrically, it has less than 1 ohm resistance at 89 meters and is tested to withstand 1200 volts 60 cycles a.c. It is well adapted for use in super-heterodyne and other circuits when dependable vernier action is essential.

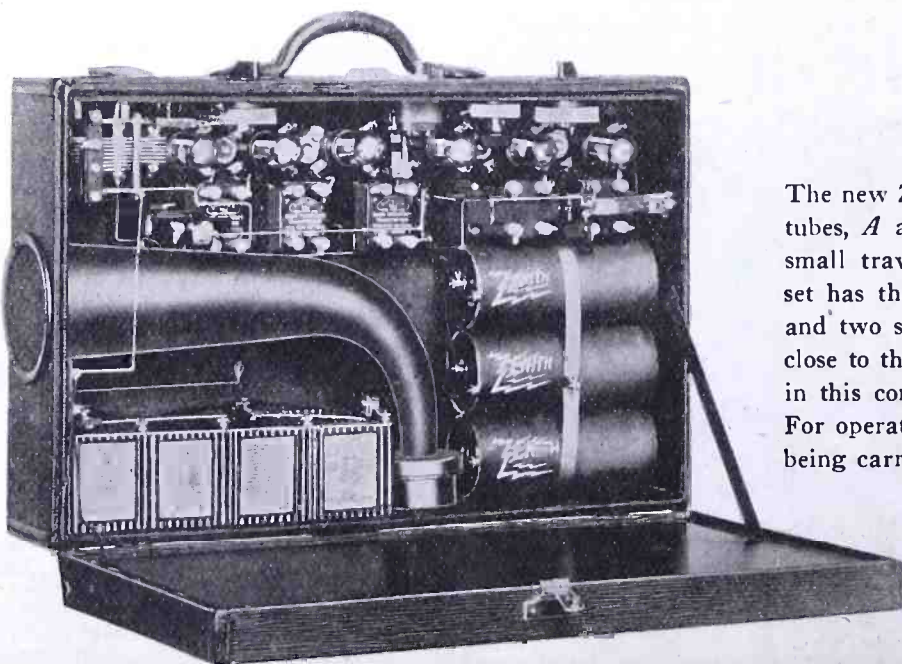

The new Zenith Super-Portable is a six-tube radio set, complete with tubes, A and B batteries, loud speaker and loop aerial, fitted into a small travelling case, the whole outfit weighing 24 pounds. This set has three stages of transformer-coupled radio-frequency detector and two stages of audio frequency. Its three controls are mounted close to the carrying handle in recessed dials. It has been designed in this compact form to give clarity, quality, volume and distance. For operation, it is unnecessary to open the case and it works while being carried. It is highly selective.

# Improve your set with an ACME "lowest loss" condenser

*Because of low losses and sharp tuning practically all the currents on the antenna can now be used*

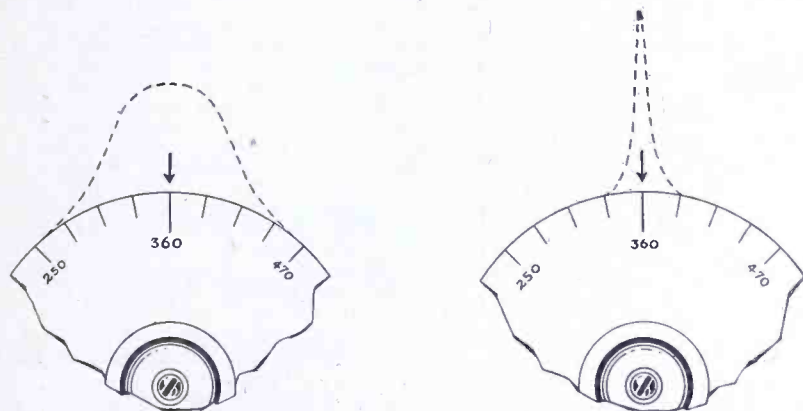

Which one is your  
tuning circuit

*--the hump or the peak?*

**H**ERE are the curves of two tuning circuits. The hump has a high loss condenser and the peak a low loss condenser. Both receive broadcasting, but the peak receives local and distant stations without interference, while the hump receives only the nearby stations with interference. The new Acme Condenser will change your tuning circuit from a hump to a peak.

The Acme engineers have been working for two years to bring out a condenser which would give to Radio experimenters sharp tuning and minimum losses. The new Acme Condenser has these fundamental advantages and also has many new improvements in structure and equipment. See the illustration with explanation, and, for more information, write to us for booklet—"Amplification without Distortion," which contains many diagrams and helpful hints on how to build and get the most out of a set.

ACME APPARATUS COMPANY

Dept. 78

Cambridge, Mass.

Booth 62 at Pacific Radio Exposition

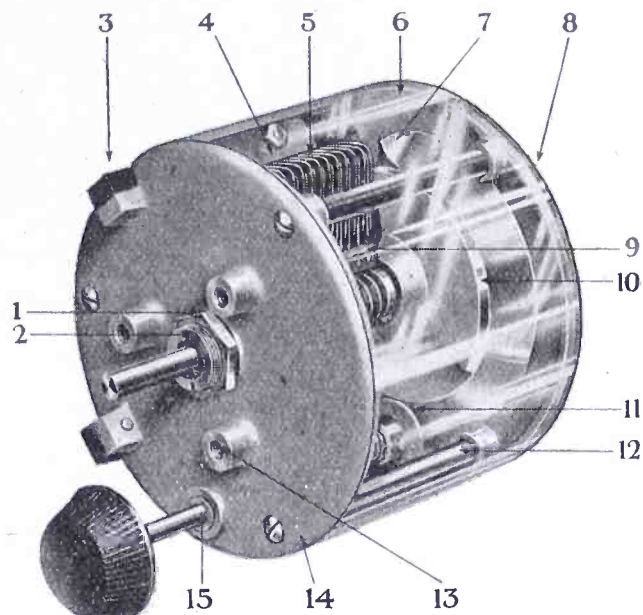

1. Steel brass cone bearings adjustable.
2. Lock nut for bearing.
3. Highest grade hard rubber Dielectric in that part of the field to prevent losses.
4. Brass separator to which both rotary and stationary plates are soldered, making continuous circuit for each.
5. Brass silver plated plates; rotary plates logarithmic.
6. Dust proof covering.
7. Stops at extreme end of movements.
8. Coiled connection between shaft and heads allowing lubrication of bearings.
9. Brass separator to which both rotary and stationary plates are soldered, making continuous circuit for each.
10. Counterweight which balances rotary plates.
11. Noiseless friction Vernier control seven to one ratio.
12. Brass separators to prevent twisting and to take strain off Dielectric.
13. Panel mounting holds for 120 degrees spacing.
14. Metal heads.
15. Steel bushing to prevent wear on Vernier shaft.

ALL parts are of non-rusting metal, except steel bearing which is covered with nickel-plated protective surface. End plate capacity is .000016 m.f., full capacity is .0005 m.f.  
Price \$6.50

*Cut out and send this coupon*

Acme Apparatus Company  
Dept. 78, Cambridge, Mass., U. S. A.

Gentlemen: I am enclosing 10 cents (U. S. stamps or coin) for a copy of your book, "Amplification Without Distortion."

Name .....

Street .....

City ..... State .....

# ACME ~for amplification

Tell them that you saw it in RADIO

See It At The Pacific Radio Exposition, San Francisco, Booth No. 48.



### The Super-De Luxe Dial

The Na-ald Super-De Luxe Dial is the crowning achievement of dial design and manufacture. It is a truly beautiful creation, which gives that final touch of dignity and attractiveness to the quality set.

All Na-ald dials express beauty. They have generous knobs which fit fingers perfectly and help to tune. Graduations, placed on the bevel of Na-ald Dials, are even, and marked with a permanent, brilliant white.

Na-ald dials are made of genuine Bakelite, with patented construction. They are trued with a diamond and provided with a generous-sized, positive-gripping set screw. No special screw-driver is required for setting.

- Na-ald Super-De Luxe (with large knob) ..... \$1.00
- Na-ald 3 7/8-in. Dial ..... .75
- Na-ald 3-in. Dial ..... 35c, or 3 for 1.00
- Na-ald 2-in. Dial ..... 35c, or 3 for 1.00

The new rotogravure booklet, "What to Build" now packed with each Na-ald product. If your dealer's stock hasn't this, send cover of any Na-ald carton or 15c for it.

**ALDEN MANUFACTURING CO.,** Dept. H. Springfield, Mass.



### CALLS HEARD

Continued from page 41

By 9AYX, Belleville, Ill.

(1fn), (1fh), 1hn, 1rb, (1db), 1my, (1kc), 1iv, 1lc, (1fs), 1ci, (1pl), 1cg, (1vc), 1ka, (1il), (1aou), 1agh, (1arc), (1aac), (1arf), 1aix, (1aur), 1akl, (1azr), (1awe), 1ayt, (1avw), 1aal, (1afa), (1adn), 1bsz, (1bsd), 1bqe, (1ber), 1bze, 1bbo, (1bom), 1bie, 1biz, (1btt), (1blb), (1bgq), (1bnt), (1bgt), (1bhn), 1bhm, (1cmx), (1cpl), (1cit), 1cpi, (1ctp), 1cbh, 1cab, 1ckp, 1cib, 1xah, (2wr), (2kr), 2vv, (2mu), (2bt), (2bm), (2aay), 2ala, (2apy), (2acr), (2abn), (2axf), 2brb, 2bwp, 2bee, (2bav), 2bgo, (2bec), 2buy, (2cac), 2cvj, (2cqp), 2cpd, 2xna, (3wb), (3hh), (3oe), (3bb), (3vw), 3gc, (3me), (3kd), (3oq), 3aeb, (3adv), 3arp, 3aoj, (3akr), 3adb, 3auv, (3bel), (3bva), 3bwj, (3bdi), (3bpp), (3bno), 3bce, 3cez, (3cgs), 3cjn, (3ccu), 4ai, 4bq, 4af, 4rr, (4dg), (4ez), (4fz), (4qy), (4ba), 4xc, 4sh, 4oh, (4li), 4oa, 4io, (4mb), 4er, 4cb, 4tj, 4kl, 4tf, (5lr), (5ad), (5eh), (5li), (5wm), (5oc), (5oq), (5aas), (5akp), (5agv), (5aiy), (5ado), (5adv), (5ajt), (5aom), (5ail), (5ajh), (5xau), (6gt), (6bh), 6tu, 6tv, 6nb dlte, 6eb, 6zp, 6qj, 6avr, 6aaq, 6agk, (6ame), 6apw, 6alk, (6bau), (6bur), 6bbw, 6bdi, 6bbe, 6bnh, 6blk, 6bpm, 6bic, (6bql), 6civ, 6emi, 6cmr, 6cgw, 6cdg, 7it, 7iw, 7fd, 7fr, 7co, 7qu, (7tq), 7iy, 7lu, 7ahv, 7adg, 7abb, 7ael, (8gp), (8ak), (8hj), (8fg), (8kc), (8rj), (8sr), (8oe), (8alm), (8aii), (8alw), (8agw), (8abs), (8alf), (8hoe), (8bcd), (8bce), (8blb), (8bpa), (8cwp), (8cmu), (8crv), (8con), (8cln), (8cwr), (8ddy), (8dbm), (8dki), (8dde), (8dkj), (8dcw), (8xhp), (8zu).  
 Can.—1ef, (2be), (2bn), 2cg, 2az, 2dn, (3xi), (3ph), (3kq), 3yh, 3pz, (3he), (3tf), 4fz, 4dq, 4ad. Mex.—bx. All west coast stns listed r hrd kdef consistently. Qrk? mi 5 or 10-watt C. W. All crds qsl'd.

At 5AOX, Sam Zimmerman, Box 483, Port Lavaca, Tex.

C. W.: 1cpn, 1epr, 2by, 3kq, 3mo, 4oa, 4qy, 4xj, 4gx, 4rf, 5za, 5sd, 5ph, 5pv, 5do, 5ak, 5on, 5gb, 5mm, 5kr, 5ho, 5uk, 5zas, 5ou, 5amu, 5ed, 5kc, 5ac, 5xa, 5hl, 5qz, 5wi, 5jw, 5qq, 5xac, 5jb, 5air, 5aki, 5aac, 5xd, 5xq, 5ajp, 5ed, other 5's too numerous, 6ajj, 6ava, 6jj, 6zn, 8bk, 8dp, 8bcj, 8zc, 8ata, 8ate, 8cgj, 8axb, 8atx, 8cfm, 8vc, 8zu, 9cc, 9cyf, 9zz, 9ebq, 9akl, 9dfv, 9wm, 9hm, 9dj, 9as, 9oz, 9ai, 9zu, 9bvd, 9avs, 9cf, 9esk, 9dun, 9caa, 9vm, 9dzi, 9ck, 9bid, 9cco, 9dyy, 9ake, 9edl, 9lp, 9erm, 9euj, 9rp, 9dak, 9axb, 9elw, 9awg, 9ear, 9ta, 9bfn, 9dml, 9cmv, 9cgv, 9edo, 9ba, 9lfp, 9ehv, 9efo, 9ai, 9erm, 9dmg, 9xn, 9dkx, 9awr, 9ee, 9dng, 9ekj, 9bsp, 9auy, 9cju, 9bfj, 9ccq, 9aed, 9aau, 9day, 9bpv, 9cao, 9djb, 9aay, 9eky, 9cvu, 9aed, 9cfi, 9hh, 9aau, 9lb, 9bhp, 9dmw.  
 Fone: 9ebq, 9esk, 9cit, 9esk, 9cgu, 9aj, 9cop, 9caq, 9ebq, 9cdl, 9xn, 9ff, 9aaq, 9gi, 9mf, 9rq, 9ei, 9lr, 9ka, 9za, 9sk, 9mn, 9jr, 9akn, 9cd, 9td, 9zai, 9xaj, 9kc, 9jb, 9ma, 9aki, 9alw.  
 Spark: 9tg, 9gy, 9hm, 9ees, 9abp.  
 Can. C. W.—5cn. Mex. C. W.—ng (qra?), es gj (qra?).

By Jack Stevenson, 5108 Wadsworth St., Los Angeles, Calif.

1js, 3bvw, 4av, 4ev, 5adb, 5ado, 5ahd, 5aiu, 5aky, 5anb, 5eo, 5es, 5ft, 5gm, 5hl, 5jl, 5jk, 5kc, 5ko, 5lr, 5mk, 5ml, 5mo, 5na, 5ns, 5xd, 5za, 5zav, 5zb, 5zh, 6abh, 6abk, 6acd, 6ach, 6acm, 6acn, 6adh, 6aea, 6aeb, 6age, 6ahz, 6aih, 6aja, 6ajj, 6alv, 6and, 6aur, 6uoi, 6aol, 6aor, 6aos, 6apg, 6apk, 6arb, 6asa, 6asf, 6atn, 6atu, 6aur, 6aau, 6avg, 6awt, 6bah, 6bbh, 6bbi, 6bbx, 6beh, 6bel, 6bcm, 6bex, 6bda, 6bdu, 6bez, 6bfa, 6big, 6bih, 6bip, 6blg, 6blh, 6bmf, 6bnf, 6bnt, 6buy, 6bud, 6cax, 6cbp, 6cbu, 6cbw, 6cca, 6cek, 6ceq, 6ccu, 6cdg, 6cdi, 6cdp, 6ceu, 6cf, 6cgd, 6cgv, 6chd, 6ehj, 6ehl, 6ehm, 6cie, 6cjb, 6cjj, 6ckc, 6cki, 6cku, 6ckx, 6clb, 6hv, 6oi, 6oz, 6pe, 6sj, 6ti, 6tq, 6tu, 6tv, 6uo, 6ve, 6xn, 6zz, 7abb, 7acf, 7adp, 7adr, 7aea, 7ael, 7aer, 7afk, 7agi, 7ahs, 7aj, 7ajd, 7ajn, 7ak, 7alk, 7ax, 7bj, 7co, 7dc, 7ez, 7ft, 7fy, 7ge, 7gf, 7hg, 7hm, 7hw, 7io, 7ks, 7kv, 7lh, 7lw, 7nn, 7ob, 7od, 7ot, 7ou, 7pj, 7px, 7qd, 7qj, 7qk, 7rn, 7sc, 7sf, 7sy, 7to, 7tq, 7tt, 7uh, 7vn, 7ve, 7wi, 7wm, 7ya, 7zd, 7ze, 7zl, 7zo, 7zu, 7zv, 8ago, 8ajz, 8avd, 8blx, 8bxs, 8cei, 8eky, 8com, 8eva, 8dat, 8gz, 8hv, 8ko, 8nd, 8om, 8sp, 8wt, 8yn, 9aac, 9au, 9afi, 9ahj, 9ahu, 9ahz, 9aim, 9ajv, 9amb, 9amu, 9apf, 9apw, 9ard, 9ati, 9aul, 9aux, 9avo, 9avz, 9awv, 9azg, 9bak, 9beu, 9bez, 9bfo, 9bik, 9bji, 9bjk, 9bli, 9bof, 9boz, 9bqi, 9bre, 9bug, 9hun, 9hvc, 9bx, 9bxt, 9bye, 9bzi, 9caa, 9cat, 9cbj, 9cek, 9cel, 9cem, 9ccz, 9eda, 9cdv, 9cea, 9cfi, 9cfy, 9cga, 9cgc, 9cgu, 9cgv, 9cgy, 9cht, 9ciy, 9cje, 9cjj, 9cld, 9cnv, 9con, 9erc, 9ct, 9cuc, 9cvs, 9czm, 9czw, 9dbf, 9dbs, 9den, 9dfs, 9dge, 9dkg, 9dqy, 9dsm, 9dte, 9dtl, 9dun, 9dxn, 9dxu, 9dyz, 9dzy, 9eek, 9tky, 9elb, 9er, 9go, 9id, 9kj, 9km, 9lc, 9mc, 9nm, 9no, 9ql, 9yan, 9yau, 9yy, 9zt.  
 Can.—4cb, 4cl, 4co, 5cn, 5go, 9bp. Mex.—bx. jh and kfz while in Mex. Alaska—7uf. Daylite: 5jk, 5za, 5zav, 6acn, 6adh, 6bez, 6cf, 6cke, 6xn, 7qj, 9apf, 9bjk, Can. 5go.

Continued on page 46.

Tested and Listed as Standard by Underwriters' Laboratories

The **FANSTEEL** **Balkite**

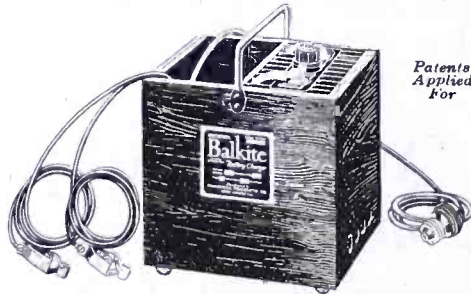

battery charger is noiseless and has no bulbs or moving parts

The Fansteel Balkite Battery Charger for Radio "A" (6 volt) Batteries is an entirely new type of rectifier, based on the use of Fansteel Balkite, a new and rare metal developed for this purpose.

1. It is entirely noiseless.
2. It cannot deteriorate through use or disuse.
3. It has no moving parts.
4. It has nothing to adjust or get out of order.
5. It cannot discharge or short-circuit the battery.
6. It requires no attention other than an occasional filling with distilled water.
7. It will not over-charge.
8. It cannot fail to operate when connected to the battery and line current.
9. It is unaffected by temperature or fluctuations in line current.
10. It is simple, efficient and indestructible except through abuse.
11. Without added attachments the charger may also be used to charge "B" storage batteries.
12. It can be used while the radio set is in operation.

The Fansteel Balkite Battery Charger will charge the ordinary 6 volt radio or automobile storage battery at 3 amperes, from 110-120 AC, 50-60 cycle current.

Price, \$20 \$19.50 East of the Rockies

Manufactured by Fansteel Products Company, Inc., North Chicago, Illinois

Sales Representatives

A. S. LINDSTROM  
111 New Montgomery St.  
San Francisco

GEORGE H. MAIRE  
95 Connecticut St.  
Seattle, Wash.

H. A. KILLAM  
312 McKay Bldg.  
Portland, Ore.

CARL A. STONE & CO.  
537 Fernando Building  
Los Angeles, Calif.

Tell them that you saw it in RADIO

Have You Ever Wondered  
What the Sea-Going Wire-  
less Operator's Life Is Like?

Read—

# “The Radiobuster”

—and find out!

A thrilling book from the skilled, whimsical pen of a wandering adventurer who has faced Arctic blizzards upon the decks of ice-crusted square-riggers and sat at the key in the radio rooms of the greatest ocean liners.

“A good series of yarns.”—*New York Herald.*

“To one who likes his radio stories crammed full of action and adventure, \* \* \* ‘The Radiobuster’ should prove an extremely entertaining book.”—*New York Telegram.*

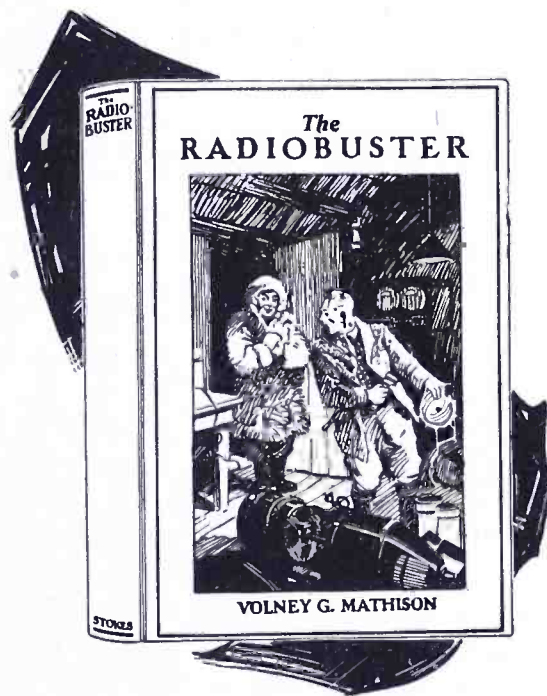

**DEALERS—**

There is a big demand for this book. Write us for trade information.

**\$1.00**  
Per Copy  
Postpaid  
in the U.S.

**RADIO FANS—**

Order your copy right now. The supply is limited.

For Sale by

## Pacific Radio Publishing Co., Inc.

Pacific Building,  
San Francisco, Cal.

17 West 42nd St.,  
New York, N. Y.

157 East Ontario St.,  
Chicago, Illinois

*Orders for copies of this book can be filled from any of our three offices.*

Tell them that you saw it in RADIO

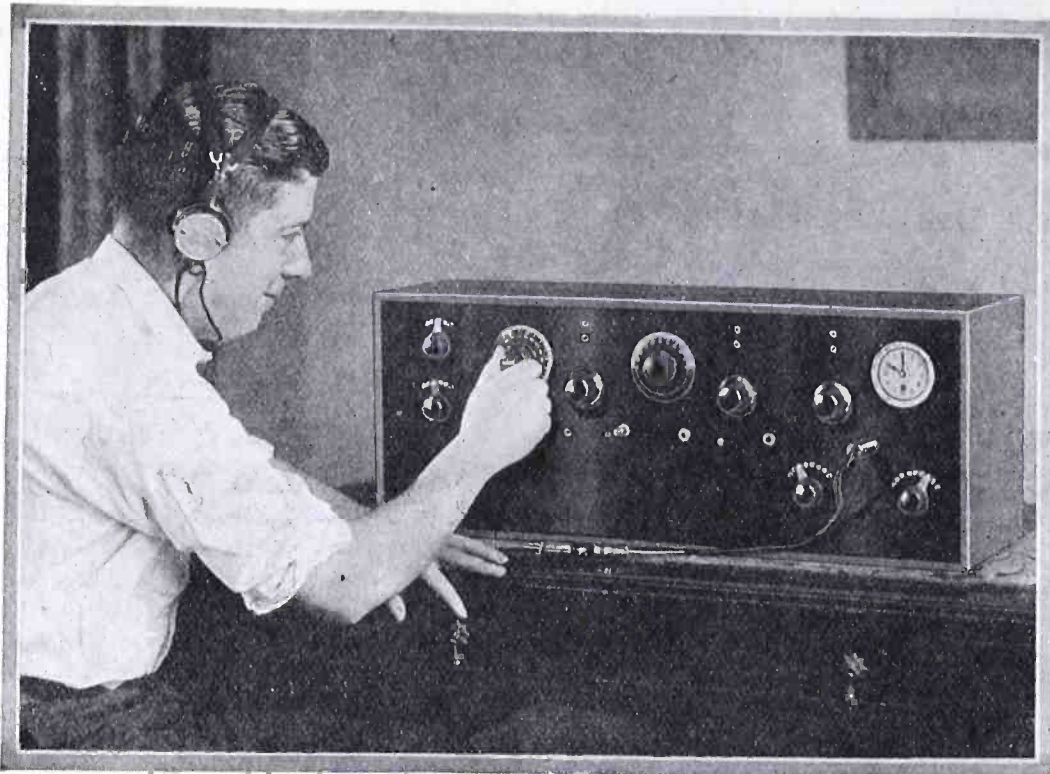

With the clock in his panel Mr. Kent checks time with the Government signals from Arlington and keeps track of broadcasting schedules. Note the beautiful finish of the Celoron panel.

## What Kent says about panels

Albert Kent builds his own sets. He uses instruments of the highest quality. He has found that it does not pay to mount his parts on just any old radio panel. He writes:

"Having completed over thirty radio receivers of various styles, I thought you would like to know of the truly wonderful results obtained with the use of Celoron panels.

"After a great deal of experimentation, I developed a simple three circuit regenerative receiver: and in order to obtain a constant normal range of approximately 2,000 miles with three tubes, apparatus of the highest quality had to be used.

"By the process of elimination, I found that Celoron was the only sat-

isfactory panel, mainly because of its extremely low loss of high frequency currents. This characteristic brings in distant stations clearly with a simple hook-up. I find working with Celoron a pleasant task and every completed receiver makes a strikingly beautiful appearance. The first one, after three years' hard use, still looks like new.

"I wish I could tell every experimenter to begin building his set in the right way by using the best obtainable panel—and that is Celoron."

### CELORON

#### A Bakelite Material

For set builders we have a special free booklet, "Getting the Right Hook-Up with Celoron." It contains valuable hints for set builders. Write to Department 4A for your copy.

## Diamond State Fibre Company

Branches in Principal Cities Bridgeport, Pennsylvania Toronto, Canada—London, England

*We Repair*

**RADIO TUBES**

WD-11, WD-12, UV-200, UV-201, C-300, C-301, DV-6, DV-1, DV-2, DV-6A, UV-199, C-299, UV-201A, C-301A, Marconi Moorhead.

6v. plain Detector, 6v. plain Amplifier

**\$2.50 for any type**

Dealers' and Agents' Special Discount

Mail orders solicited and promptly attended to

**H. & H. RADIO CO.**

P. O. Box 22-M, Clinton Hill Sta., Newark, N. J.

### HEATH RADIANT CONDENSERS

Micrometer geared vernier enables hair-line adjustment.  
PERMANENTLY FLAT PLATES  
**HEATH RADIO & ELECTRIC MFG. COMPANY**  
208 FIRST ST., NEWARK, N. J.  
Canadian Distributor: Marconi Wireless Telegraph Co. Montreal, Canada

### Distance! The Only AUTHORIZED COCKADAY COIL

Gets distant stations easily and clearly. Made in strict accordance with specifications by L. M. Cockaday, inventor of the famous Cockaday Four Circuit Tuner. Greater volume, sharper tuning, maximum selectivity. Guaranteed. At your dealers—otherwise write us direct.  
**PRECISION COIL COMPANY**  
200-C Centre Street New York

Continued from page 44

By 8DBM, Wooster, Ohio

- C. W.: (1ah), 1ay, (1ci), 1db, (1fm), 1fs, 1gh, 1gl, 1gv, 1ii, 1il, 1ko, 1kw, (1kx), 1ml, 1mv, (1my), (1nd), (1nt), (1py), 1qm, 1qr, 1rr, (1se), 1sw, 1sn, 1sk, (1uj), (1vc), 1vq, (1wd), 1wo, 1xz, 1yb, 1yk, 1zj, 1zt, (1aal), (1aur), 1aol, (1aoo), 1apc, 1aqu, (1are), 1arp, (1ary), 1asd, 1ask, (1atj), (1auk), (1aur), (1avf), (1avj), 1avx, (1awe), 1awy, 1axn, 1ayi, (1ayt), 1azr, (1bcr), 1bec, 1bes, 1bez, (1bge), 1bhn, (1bie), (1bip), 1biz, 1bis, 1bjo, 1blb, (1bnt), 1bom, 1boq, (1bqd), 1bqk, 1bql, (1bsd), (1bsz), (1btt), 1bub, (1bvr), 1bwj, (1cab), 1caz, 1ebj, (1ede), 1cer, 1cfj, 1egq, 1chk, 1cib, (1cit), (1cjo), 1ckr, (1cmp), 1cmx, 1coe, (1cre), (1ctp), 1esz, 1xah, 1xam, 1xaq, (2al), (2bm), 2bt, 2cg, 2cx, 2em, 2fj, 2gk, (2jf), 2kf, 2ku, 2kx, 2le, 2me, 2mu, (2qf), 2qs, 2rk, 2rm, 2ts, 2wb, (2wr), 2aay, 2aco, (2acs), 2adc, 2adk, (2aey), 2ale, (2aoo), (2aoy), 2ana, 2ane, 2atf, (2axf), 2ayo, 2azy, 2bbn, 2bbx, (2bee), 2beo, (2bbg), 2bgj, (2bgo), (2blp), 2bqh, (2bqu), 2bqv, (2brb), 2bre, 2bse, (2buy), (2bxp), 2bxw, 2byd, (2byg), (2cdp), (2cee), 2cez, 2cgj, 2cgk, 2chz, (2cjr), 2cwo, 2cla, (2cor), 2cpa, 2cpd, 2cqz, 2csl, 2csr, 2cts, (2cyu), (2cwj), 2cwp, 2cxd, 2cxl, (2cxw), (2cxy), (2czz), 2czy, 2dae, 2xna, 3be, 3bj, (3bx), 3cx, 3ds, (3dt), 3dq, 3gc, 3gr, 3hg, (3hh), 3hi, (3ii), (3iw), (3je), (3kd), 3lg, 3ln, (3ly), (3me), (3mk), 3ms, (3oe), 3oq, 3pz, (3qt), 3sd, (3sh), (3sl), 3sm, (3tf), 3ty, (3tr), 3vw, 3wf, (3wx), 3yo, 3abw, 3adb, (3ade), 3adt, 3adv, (3aek), (3afb), 3agf, (3ahp), 3ajn, (3akl), (3ale), (3alx), (3apv), (3apc), 3aqr, (3atb), (3auv), 3ava, 3avm, 3avy, 3awa, 3baq, 3bbt, (3bbu), 3beg, 3bdi, (3bdo), 3bdr, 3bgj, 3bhv, 3bkl, 3blp, (3bmn), 3bmz, (3bpf), 3bpm, 3bpp, 3bpw, (3brf), 3bsb, (3bta), (3btl), 3buu, (3buy), (3bva), 3bvv, (3bwt), 3cah, 3ccd, (3ccu), (3ccv), 3ccx, (3cdk), (3cdu), (3cel), 3cez, (3cfn), 3ckj, (3ckl), 3ckp, (4ab), (4af), 4ag, (4ai), (4ba), 4bx, 4cl, 4db, 4dt, 4dv, (4eq), 4er, 4ez, (4fa), 4fs, (4fz), (4gv), 4gz, (4hr), (4hs), 4ik, 4io, (4it), 4iu, 4jd, 4jk, (4jr), 4jv, (4li), 4lj, (4ll), 4mb, (4mi), 4my, 4nd, (4oa), 4og, 4oh, (4pb), (4pi), (4pk), 4pv, (4qw), 4qy, 4rf, (4rr), (4sh), 4sb, (4sf), (4su), wx-5 (5bd), 5bx, (5bz), 5ce, 5cm, (5cv), (5dj), 5dm, 5dq, 5dw, 5ed, 5eh, 5ei, 5ek, 5fj, (5fu), (5gn), 5gm, 5hy, 5in, (5io), (5ka), 5kc, 5kf, (5kg), 5lr, (5mb), (5mi), 5ml, 5mo, 5mq, (5na), 5nk, 5nw, 5od, 5ph, 5pv, 5pw, 5qh, (5qi), (5ql), 5qq, (5qy), 5qz, (5rg), 5rj, 5ro, 5ru, 5rv, 5sd, 5sz, 5tj, (5to), (5ts), 5ua, 5uk, 5uu, 5vc, 5vm, 5vv, (5we), 5ws, 5xd, 5yw, (5zb), 5zr, (5aac), 5aaq, (5aas), 5aaz, (5abf), 5abn, 5abw, (5adv), 5aek, 5afq, (5agh), 5ags, 5agt, 5ahd, 5ahh, 5aic, (5air), (5aiu), (5aiy), (5ajb), (5ajg), (5ajj), (5ajq), 5ajt, 5alr, (5alv), 5alx, (5alz), (5amg), (5amu), 5anc, 5anf, 5anw, (5aom), 5aqr, 5zas, (5zv), 6ao, 6bh, 6bm, 6ea, 6en, 6fc, 6fp, 6gr, (6gt), 6lv, (6nb), 6nx, 6of, 6rn, 6tv, 6uw, 6vb, 6zi, 6zt, 6aao, (6aaq), 6abx, 6acm, 6adh, 6age, 6agk, 6afa, 6ahp, 6akj, 6akz, 6aoc, 6ape, (6aqd), 6arb, 6arw, (6avr), 6avv, 6auu, 6awq, (6bau), (6bbc), (6bbw), 6bcl, (6bdi), 6bdt, 6bic, 6bih, 6bik, 6big, 6blw, 6bmr, (6bnt), 6bnu, 6bqe, 6buh, (6bui), 6buy, 6bvr, 6bvz, 6cbd, 6cdg, 6cej, (6cek), 6cee, 6ceg, 6ego, 6egs, 6cgv, 6cgw, 6cic, 6civ, 6ckr, (6cmr), (6cmu), (6cng), 6zah, 6zar, 6zba, 6zcd, (7bj), 7br, (7co), 7fa, 7fd, 7fq, 7fs, (7go), 7hw, 7ij, (7iw), 7lh, 7pw, 7qc, 7to, 7tq, 7wp, 7zu, (7abb), 7adi, 7afs, 7aiy, 7akh, (8iy), (8dde), (8dam), (8yah), 9ak, 9ap, 9az, (9bk), (9ck), 9cp, 9ca, (9dp), (9dr), 9du, (9ef), (9ep), (9er), 9eq, 9fb, 9fm, 9hd, 9hg, (9hm), (9hw), 9hz, 9kd, 9la, (9lb), (9le), 9lz, (9mc), 9mm, 9no, 9nu, (9ou), 9pf, (9po), (9qe), 9qi, 9ql, (9ro), 9ss, 9st, 9tm, 9ur, 9vc, (9vm), 9vz, (9wu), 9yy, 9zt, 9za, (9aa), (9au), 9abc, 9ach, (9aci), (9acs), 9add, (9adp), 9aec, 9aef, 9aen, 9aep, 9af, (9afy), (9agb), (9agl), (9agz), 9ahj, 9aih, 9ahq, (9ahv), 9aic, 9aif, 9aim, (9aju), (aku), 9ajw, (9alc), 9alx, 9alz, 9amb, (9amf), 9ami, 9amp, 9amq, 9amu, 9ana, 9aog, 9aom, 9aou, 9apd, (9ape), (9apf), 9aqc, (9aqd), 9aqk, 9aqg, (9aqq), 9aqj, 9arr, (9aru), (9ase), (9asn), (9asx), (9ato), (9arf), (9aua), (9aue), 9auc, 9avc, 9avg, 9avn, 9avs, 9avt, 9awp, (9awv), (9axs), 9ass, 9awe, (9ayj), (9ayl), 9ayp, (9ayx), (9azg), 9azj, (9azr), 9azv, 9bav, (9bbg), (9bch), (9bex), (9bdc), 9bdb, 9beb, (9bed), 9bes, (9bep), 9bez, (9bfi), (9bfp), 9bgc, (9bgh), 9bgx, 9bhh, (9bhi), (9bhq), 9bib, (9bie), 9bis, 9biv, 9biz, 9bjr, 9bjt, 9bkk, 9bhl, (9hld), 9blm, 9blr, 9bly, 9bmd, 9bmu, (9bmx), (9bna), 9bnv, 9bop, 9bpm, 9bpn, (9bps), 9bpv, 9bpu, 9bqa, (9bqj), 9bq, (9brk), 9brs, 9bso, (9btt), 9buj, 9bui, 9bsj, (9bss), (9btk), (9btl), 9bttm, (9btt), 9bun, 9buu, 9bvs, 9bvt, 9bvn, (9bvv), 9bwc, 9bww, (9bxl), 9bxq, (9bxw), 9byx, 9byz, 9bzh, 9bzc, 9bze, 9byp, (9caa), 9cay, (9ceg), 9ccn, 9cjh, (9ccs), 9ccw, 9ccz, 9cda, (9cdb), (9cdo), 9cdu, 9cee, (9ceh), 9cek, 9cej, 9cel, 9cfi, 9cfl, 9cgb, 9cgn, 9cic, 9cis, (9cjm), 9cnc, (9chn), (9che), 9cho, (9cii), (9ciu), 9cip, 9cin, 9cja, (9cje), (9cka), 9ckh, (9cko), 9cld, 9cly, 9cmc, (9cme), 9cmn, 9cow, (9cpc), 9cph, 9cpz, 9cpu, 9crm, 9crx, 9csr, 9ctg, 9ctr, (9cvo), (9cvf),

Continued on page 48

Tell them that you saw it in RADIO



**THE GREATEST RADIO SHOW YET HELD IN AMERICA WILL BE STAGED IN THE CIVIC CENTER AUDITORIUM, SAN FRANCISCO, AUGUST 16-21. THERE WILL BE 150 EXHIBITS—MANY OF THEM DIRECT FROM THE EASTERN FACTORIES. EVERY EXHIBIT WILL BE A SHOW IN ITSELF. NUMEROUS LEADERS OF THE RADIO INDUSTRY WILL BE AT THE SHOW TO DEMONSTRATE THEIR LATEST INVENTIONS. IT WILL BE A CO-OPERATIVE AND NON-PROFIT SHOW—CONDUCTED BY THE PACIFIC RADIO TRADE ASSOCIATION FOR THE GOOD OF RADIO.**

---

*Admission—25 Cents*

---

**PACIFIC RADIO EXPOSITION**

*Executive Offices—***PACIFIC BUILDING, SAN FRANCISCO**  
17 WEST 42nd ST., NEW YORK    157 E. ONTARIO ST., CHICAGO    52 IRVING ST., BOSTON

Tell them that you saw it in RADIO



## “Simply Divine”—Tamaki Miura

THE golden witchery of Tamaki Miura's internationally famous art finds ideal counterpart in the marvelous purity and tone quality of Erla Duo-Reflex reception.

“Never have I heard anything so beautiful,” concludes the eulogy of the Japanese nightingale upon the supreme flawlessness of Erla reproduction. “The tone is simply divine, so pure, so perfectly natural.”

Foremost musical authorities of all nations acclaim the exquisitely true, rich tone exclusive to Erla receivers as the ultimate in radio achievement.

Responsible for this unique excellence are Erla radio and audio transformers, synchronizing perfectly received and reflexed radio, as well as rectified radio and reflexed audio currents, in their simultaneous passage through amplifying tubes, with consequent unprecedented elimination of distortion.

You, too, can enjoy outstanding Erla superiority, at minimum effort and cost. Complete Erla parts, for sale by leading dealers, are assembled into the most modern and efficient of receivers in a few hours' time. Easily understood blueprints guide every step.

Ask your dealer; or write, giving your dealer's name.

Manufactured by **Electrical Research Laboratories**, Dept. H, 2500 Cottage Grove Ave., Chicago  
 Coast Representative **Globe Commercial Co.**, 709 Mission Street, San Francisco

# ERLA



Supreme sensitiveness and amplifying power of Erla reflex transformers is the secret of unmatched Erla range and volume. List, \$5



None but Erla transformers are encased in costly, one-piece, drawn steel housing, completely eliminating magnetic interaction. List, \$5



Superior accuracy of Erla tested capacity condensers is invaluable for securing utmost efficiency from any receiving unit. 30c to 75c.

Continued from page 47

(9cvi), (9cvv), 9cwz, 9cyb, (9cyd), 9cye, 9cyn, (9cyw), 9czg, 9czm, (9daw), (9day), 9dbj, 9dbk, (9dbm), 9dbw, 9dce, 9dch, 9dct, (9dcw), 9dct, 9dde, 9ddd, 9dev, 9dfh, 9dfn, (9dfq), 9dft, 9dga, (9dgi), 9dgv, 9dhh, 9dho, 9dhr, 9dhs, 9dhw, (9dip), (9dja), 9djb, 9dkb, 9dkh, 9dli, 9dlm, 9dlq, (9dlr), 9dlv, 9dlw, 9dmc, (9dmj), (9dng), 9dnn, 9doe, (9dof), 9doj, (9dpp), 9dqr, 9dqu, (9dro), 9drs, 9dry, 9dsa, 9dsv, 9dsw, 9dsx, (9dte), 9dtn, (9dtt), 9duc, (9dub), 9dun, (9dvw), 9dvn, 9dwa, 9dwn, (9dwx), 9dwe, 9dxc, 9dxx, (9dxi), 9dxx, 9dyt, 9dyz, 9dzf, 9dzo, 9dzs, (9dzu), (9eak), 9eam, (9ebh), 9edb, (9edd), 9edo, 9eeg, 9eep, 9eer, (9eev), (9efh), 9efq, (9efz), (9egu), (9egw), (9eht), 9ehw, 9ehi, (9ehj), (9eib), (9eja), 9ejo, (9ejx), (9ejy), 9ekf, (9eky), (9ela), (9elb), (9ell), 9elz, 9elw, 9xbd, 9xbe, 9yau.  
 Can.—1bd, 2az, 2be, 2bg, 2bn, (2cg), (2cm), (2do), 2fo, 2hg, (3bi), 3db, (3ia), 3if, (3kq), (3ms), (3oh), 3rg, 3tf, 3vh, 3ws, 3yv, (3yh), 3yv, 3zt, (3adu), 4co, 4dq, (4fz), 9bx.  
 I. C. W.: 1ckp, 2ana, 2atf, 2bbx, 2bqb, 2cwx, 3gc, (3qv), 3ud, 3adv, (3ahp), (3ava), (3blp), (3cdn), 4bz, (4hw), (5aaw), (5cn), 5agj, (5aom), 8vq, 9dc, 9rc, (9aaw), (9aec), (9afy), 9ahj, (9amf), 9aor, 9aus, 9bqj, 9brx, (9bzi), 9ecs, 9edb, (9cyd), (9cyg), 9day, 9dqu, 9drs, 9dxx, (9edb), (9yau), (2cnk).  
 Fone: 3hom, 5amf, 5ana, 5za, 8com, 8ann, 8com, 8dde, (9arf), 9dzo.  
 Spark: 1ave, 1btf, 2om, 2rp, 2bpr, 2bqz, (3hj), (3jj), (3), 3me, 3oe, (3qv), 3rp, 3sf, 3acy, 3brl, (4hl), 4ez, 4hs, 4io, 4mv, 5bs, 5qz, (4fg), 5agv, 8ew, 8tj, 8ao, 8atr, 8axn, (8bda), 8ced, 8cvh, 9ca, 9cs, 9nq, (9yj), 9aaw, 9ajw, 9amz, (9aru), 9bag, 9bux, 9civ, (9crm), 9czl, 9dhz, 9dtn, 9duu, 9ees.  
 Dalite C. W.: 1fd, 1fh, 1iw, 1va, 1aez, 1afa, 1akl, 1all, 1arp, 1atj, 1aww, 1vr, 1bge, 1bof, (1bqe), 1bvx, 1caz, (2hj), 2bm, 2aay, 2acs, 2ana, 2cqi, 2chz, 2cqi, (2crp), 3hh, 3iw, 3lg, 3oq, 3ph, 3te, 3uz, 3ahp, (3alr), 3agr, 3arp, 3bez, 3bge, 3bkl, (3blc), (3bml), (3bva), (3bwt), 3cbl, 3cbx, 3cdk, 3cdn, 3ckj, (3ckl), 4gv, 4hs, (4mi), 4si, (5be), 5fj, 5fv, (5qd), 5qh, (5aaz), 5ajb, 9es, 9fb, 9lb, 9le, 9vc, (9wc), (9abl), 9ach, (9aem), 9afy, 9agb, 9agy, (9ahj), (9ahq), 9aio, 9ajd, 9amt, 9apd, 9aqb, 9aui, 9aus, 9avb, (9awq), 9azp, (9bec), 9bec, 9bgh, 9bhh, 9bkj, 9boe, (9bpt), 9brx, (9btt), (9buk), 9bvw, 9ccv, 9cdo, 9cfk, 9cfi, 9cea, 9cmz, 9cno, (9esy), (9exx), 9cyw, (9dap), 9dcp, 9dcw, 9dlo, (9dlr), 9dzo, (9eak), 9efz, (9eja), 9ekf, (9eld). Can.—3db, (3ia), (3xi), 3yv.  
 I. C. W.: 1bbo, 2aay, 3lg, 9amk, 9bqj, 9csw, (9diz), kdef.  
 Spark: 4io, 8th, 8bfy, (8ctd), 9bef. Crds qsl'd and appreciated—especially fm N. Mex., Nev., Idaho, es Wyo.

By Lynn McMoran, R. F. D. No. 1, Mt. Vernon, Wash.

1bdu, 1wa, 2um, 2aw, 2cla, 2xi, 5ajj, 5alj, 5kc, 5hc, 5kc, 6cef, 6avv, 6wo, 6am, 6efa, 6dn, 6cgo, 6aja, 6ajo, 6buh, 6cla, 6ajc, 6dd, 8ar, 8boe, 8abs, 8avd, 8ad, 9awc, 9ajs, 9jw, 9xw, 9sp, 9aap, 9wc, 9ahz, 9asw, 9bpv, 9eep, 9jo, 9cqa, 9jc, 9xn, 9kk, 9kc, 9aj, 9aru, 9ub, 9aj, 9ul, 9cwm, 9bwu, 9au, 9agr, 9cwa.  
 Can.—4aj, 4aw, 4cn, 4dq, (5ek), (5hk), 5aw, 5is, 5ak, 5eh, 5du, 5as, 5ah, 5bc.  
 Phone: 7ali, 7gl, 7qc, Can. 5ef, 5hk, 2xil  
 All cards answered.

By 6ACM-6ZCD, 2130 Emerson St., Palo Alto, Calif.

1ag, 1ayt, 1br, 1bdi, 1ze, 1xae, 1xah, 2agb, 2cee, 2cpd, 2rk, 2xr, (3adb), 3abw, 3fs, (3hh), 3me, 3oi, (3qv), 4ao, 4bz, 4cb, 4cs, 4eq, 4er, 4fs, 4ft, 4fz, 4gf, 4gu, 4gx, 4hs, 4ik, 4io, 4oa, (4xc), 4za, 5aac, 5aar, 5aaw, 5acc, 5adb, 5ado, 5agv, 5ahr, 5air, (5aiu), (5ajh), 5ajj, 5ajp, 5ajt, 5aky, 5amb, 5amo, 5amu, 5anc, 5ev, 5dc, 5do, (5dw), (5ef), 5ek, 5fj, 5ga, 5gj, 5gm, 5in, 5je, 5kj, 5kx, 5lr, 5lg, 5mi, 5na, 5nw, 5ph, 5rv, 5sz, 5to, 5uk, 5ve, (5xd), 5za, 5zal, (5zav), 5zh, 8abs, 8acy, 8age, 8aig, 8anp, 8apt, 8ard, 8avt, 8azr, 8bce, (8bda), 8bf, 8bmk, 8bog, (8bpa), 8cci, 8cfq, 8ckv, 8cpx, 8cxi, 8cyu, 8czy, 8czz, 8dac, 8dak, 8dcy, (8dgp), 8djn, 8dp, 8er, 8es, 8fm, (8jj), 8kg, 8oa, 8pl, 8rj, (8rn), 8ry, 8uk, (8vy), 8wp, 8xan, 8xc, 8xe, 8xs, 8yn, 9aab, 9aau, 9ab, 9aci, 9aez, 9aft, 9agl, 9ahz, 9aim, 9aks, 9ami, 9amu, 9amv, 9aou, 9apf, 9aqc, 9asn, 9ato, 9ats, 9avs, 9awv, 9axx, (9azg), 9bab, 9bay, 9bcb, 9bdf, 9bed, 9bez, 9bhw, 9bih, 9bic, 9bis, 9bji, (9bkf), (9bly), 9bmx, (9bof), 9bp, 9bpv, 9bsi, 9brk, 9brs, 9bum, 9bus, 9bzcn, 9bxq, (9bzh), 9caa, 9cem, 9ccv, 9ccz, 9cdo, 9cek, (9cdv), 9ceq, 9cfy, 9cgn, 9che, 9cho, (9cht), 9cjh, 9cjj, 9cjm, 9cjq, 9cjr, (9cka), 9cki, 9ckm, 9ckz, 9cmk, 9err, 9ctr, 9cvc, 9cvo, (9cxp), 9czg, 9czm, 9czw, 9czx, 9dbh, 9dce, 9dce, 9dfh, 9dge, 9dgv, 9dmk, 9dp, 9dpx, 9dte, 9dtg, 9dug, 9dun, (9dvw), 9dwn, 9dxn, 9dxx, 9dxu, 9dxy, 9dyi, 9dyz, 9eam, 9edb, 9eea, 9ehj, 9ehn, 9ei, 9eja, 9eky, 9eld, 9elj, (9elv), 9eq, (9hm), 9ih, 9mc, 9oa, 9qe, 9ry, 9vm, 9xax, 9xbe, 9yu, Mex. hx.  
 Can.—3eb, 3je, 3vh, 3ws, 4ab, 4cb, 4cl, 4co, (4dq), 4ef, 4er, 4fn, 4hh, 4io, 5as, 5ct, 5cn, 5ef, 5go, (5hq). Wud appreciate reports on our sigs.

# RADIO INSTITUTE OF AMERICA

TRAINING IN ALL COMMERCIAL BRANCHES OF RADIO

If you cannot attend the Radio Institute of America in person the same instruction can come to you through our recently inaugurated “HOME STUDY COURSE”—Investigate.

Detailed information free on request.

Conducted by

THE RADIO CORPORATION OF AMERICA

331 Call Bldg.  
98 Worth St.

Phone Douglas 3030  
Phone Franklin 1144

San Francisco, Calif.  
New York City

Tell them that you saw it in RADIO

By 6BQE, J. F. Moss, 1422 Allison Ave., Los Angeles, Calif.

1abf, 1ajp, 1akl, 1bcr, 1bgq, 1ci, 1cmp, 1fd, 1gv, 1kc, 1xak, 2agb, 2bqh, 2cqq, 2gk, 2rk, 2xac, 2bg, 3bj, 3gk, 3hh, 3lg, 3mb, 3pz, 3xaq, 4ai, 4bq, 4cs, 4ft, 4io, 4oa, 4qy, 4xc, 4xe, 4xu, 5aar, (5adb), 5ado, 5age, 5agl, 5ahd, 5ahr, 5aic, 5air, 5aiu, 5aja, 5ajb, 5ajj, 5akf, 5akn, 5aky, 5alx, 5amw, 5az, 5be, 5bm, 5bz, 5cv, 5dw, 5ft, 5gm, 5he, 5ht, 5je, 5jl, 5lr, 5mi, 5ml, 5mo, 5na, 5nn, 5ov, 5po, 5pw, 5qd, 5ql, 5qq, 5qy, 5tj, 5ug, 5uo, 5va, 5vf, 5vl, 5vm, 5xab, 5xat, 5xaw, 5xd, 5xt, 5za, 5zav, 5zaw, 5zax, 5zh, 6ceu, 7acf, 7aci, 7adm, 7adp, 7adr, 7ads, 7adt, 7aea, 7ael, 7afe, 7afn, 7afu, 7age, 7agi, 7agv, 7agx, 7ahs, 7ahv, 7aim, 7aip, 7ajv, 7akm, 7akz, 7ald, 7amu, 7aov, 7bj, (7br), 7cf, 7co, 7dc, 7du, 7ea, 7em, 7ez, 7fd, 7fl, 7fq, 7gh, 7gp, 7gr, 7hg, 7hi, 7hm, 7hw, 7ij, 7io, 7it, 7iw, 7iy, 7jd, 7jv, (7ks), 7lh, 7ln, 7lr, (7lw), 7ly, 7nn, 7ob, 7oh, 7ot, 7pj, 7qc, (7qj), 7qu, 7rd, 7sc, 7si, 7so, (7sy), 7to, (7tq), 7tt, 7vn, 7wm, 7ws, 7ya, 7yl, 7zd, 7ze, 7zf, 7zl, 7zn, 7zo, 7zr, 7zt, 7zu, 7zv, 7zw, 7zx, 7zz, 8acy, 8agp, 8amm, 8aol, 8aoq, 8apn, 8apt, 8atc, 8bda, 8bdu, 8bfm, 8bly, 8bxh, 8bzc, 8bzy, 8cdz, 8cfd, 8cgl, 8chy, 8cpk, 8cud, 8cwu, 8dat, 8dhs, 8fm, 8fu, 8gz, 8hv, 8jj, 8jy, 8oa, 8pl, 8qk, 8tv, 8wx, 8xba, 8xbh, 8xbp, 8xc, 8xs, 8yn, 8yv, 8zc, 8zz, 9aaq, 9aau, 9aav, 9acw, 9aep, 9aey, 9afm, 9ahj, 9aim, 9aiy, 9al, 9amb, 9ami, 9amk, 9amm, 9an, 9and, 9aon, 9ape, 9apf, 9aqc, 9arj, 9atn, 9auw, 9avn, 9avs, 9avu, 9awv, 9azg, 9bav, 9bcb, 9bcg, 9bdz, 9bed, 9beu, (9bez), 9bfb, 9bfc, 9bfp, 9bhd, 9bik, 9bjk, 9bkf, 9bly, 9bmj, 9bmx, 9bof, 9boz, 9bp, 9bqj, 9bqq, 9bre, 9bri, 9bsp, 9bto, 9btt, 9btv, 9bug, (9bun), 9bu, 9bxq, 9bze, 9bzi, 9caa, 9can, 9ccz, 9cdv, 9ceh, 9cfi, 9cfy, 9cga, 9cgu, 9cht, 9cju, 9cjj, 9cka, 9cld, 9clq, 9cly, 9cpu, 9crl, 9crr, 9csi, 9cte, 9ctg, 9cvc, 9cvo, 9cwj, 9cyw, 9czg, 9czm, 9dcp, 9dew, 9dfh, 9djb, 9dkb, 9dkq, 9dky, 9dli, 9dpp, 9dpx, 9dro, 9drw, 9dsw, 9dte, 9dtm, 9dug, 9dui, 9dun, 9dwn, 9dxn, 9dxr, 9dyr, 9dzo, 9dzy, 9eae, 9eak, 9ebt, 9eea, 9eep, 9efh, 9egh, 9ehj, 9ekf, 9eky, 9elv, 9ely, 9gz, 9hs, 9mc, 9ql, 9rc, 9ss, 9vm, 9wm, 9xaa, 9xat, 9xax, 9xba, 9xbe, 9xcb, 9xw, 9yt, 9yy, 9zt, 9zy.

Can.—3aa, 3bp, 3bq, 3co, 3kg, 3xn, 4oo, 4cw, 5cn, 5go, 9bp, 9bx. North Pole—wnp. Air Mail Service—kedf voice and c.w. 6BQR is gld to qsl crd to any station listed. Pse note the new qra es qsl there. Tnx.

By 6BQA, 855 Birch St., Los Angeles, Calif.

1ci, 1ka, 1akl, 1aur, 1bcr, 1cpn, 2gk, 2wr, 2agb, 2bcs, 2brb, 2cdp, 2cee, 2clw, 2xab, 3hs, 3hh, 3bva, 3me, 3qv, 3yo, 4cw, 4eb, 4eq, 4fz, 4hf, 4hs, 4ll, 4mb, 4my, 4oa, 4xc, 5ap, 5bx, 5bd, 5cv, 5bm, 5dm, 5dw, 5eh, 5ek, 5ft, 5ga, 5gj, 5gm, 5in, 5io, 5jl, 5kc, 5lr, 5lp, 5mi, 5ml, 5mq, 5na, 5nn, 5nw, 5ov, 5ph, 5pl, 5qd, 5ql, 5qy, 5qh, 5rg, 5rv, 5xd, 5xv, 5aac, 5aar, 5aas, 5aaw, 5adb, 5ahd, 5aic, 5aiu, 5agv, 5ain, 5aiy, 5ajb, 5ajd, 5ajj, 5akn, 5alv, 5amo, 5amu, 5anc, 5za, 5zav, 7bj, 7af, 7cf, 7cw, 7ei, 7em, 7ey, 7eh, 7fq, 7gd, 7gr, 7gp, 7gq, 7gk, 7gw, 7ip, 7it, 7jw, 7ke, 7ks, 7lh, 7lr, 7ly, 7ln, 7mi, 7ju, 7no, 7om, 7of, 7ot, 7nf, 7qc, 7sh, 7ut, 7vn, 7wd, 7abb, 7acf, 7adg, 7adp, 7afe, 7afk, 7afn, 7ahs, 7aci, 7ajy, 7akh, 7akk, 7ald, 7xaf, 7xbd, 7zd, 7zu, 8cc, 8er, 8fj, 8fm, 8kc, 8ry, 8vq, 8amm, 8apt, 8axk, 8bce, 8bfh, 8cjd, 8cku, 8cwr, 8dgp, 8dha, 8dkj, 8ept, 8drq, 8xbp, 8xbq, 8zk, 8zm, 8zr, 8zae, 9ca, 9ee, 9dp, 9eq, 9hm, 9pe, 9ql, 9rc, 9ss, 9ach, 9vn, 9aam, 9aim, 9agb, 9ahx, 9amb, 9amu, 9ake, 9awa, 9avn, 9and, 9abr, 9agl, 9abc, 9aqc, 9azg, 9azj, 9awv, 9atn, 9amx, 9amp, 9bbs, 9bab, 9alc, 9fm, 9bhy, 9bdj, 9bix, 9bem, 9bez, 9bmx, 9bfp, 9brk, 9bsi, 9bsp, 9bkf, 9aec, 9bpv, 9btk, 9btl, 9bto, 9bmu, 9bwz, 9bwq, 9bxc, 9bun, 9bvn, 9bof, 9bqq, 9bxq, 9byc, 9caa, 9caj, 9cea, 9cfr, 9ccz, 9byb, 9chc, 9ccv, 9cfx, 9cld, 9cjm, 9clq, 9cip, 9cqa, 9cka, 9cmk, 9cdv, 9cms, 9clz, 9cej, 9cjm, 9cxp, 9cwj, 9cvm, 9cvt, 9cvo, 9cwr, 9ctr, 9cpz, 9bpt, 9cob, 9dai, 9biz, 9dbf, 9det, 9dca, 9czm, 9dap, 9dcw, 9dnd, 9dmj, 9dlm, 9djp, 9dun, 9djb, 9dol, 9dhw, 9dwn, 9dtt, 9dxy, 9dyz, 9dyr, 9dyi, 9dsu, 9dte, 9dpp, 9eak, 9eea, 9eht, 9eld, 9elv, 9ejo, 9ess, 9eij, 9eky, 9ekf, 9eht.

Can.—3bp, 4cb, 4cl, 4co, 4cs, 4hh, 4fz, 5go, 5cn, 5ct. Mex.—bx. Pse qsl if u ever hr mi sigs.

By 6CIX-6ABO, 317 N. Friends Ave., Whittier, Calif.

(1are), 1awe, (1bsd), 1ci, (2brb), 2cla, 2cvj, (2wr), 3adb, 3aec, 3hg, 3me, 4bz, (4eb), 4eq, 4io, 4oh, 5aaq, 5adb, 5ajj, 5amo, 5amu, 5anh, 5az, 5cs, 5et, 5gj, (5lm), 5mt, (5ph), 5ql, 5qh, (5rg), 5rv, 5sd, 5vm, 5xd, (6ano), (6asv), 7abb, 7adg, 7ael, 7afe, 7aia, 7aim, 7akh, 7ald, (7ax), 7dm, 7em, 7fq, (7fv), 7gp, 7gr, 7gu, 7hq, 7ij, 7iw, 7lk, 7ls, 7ly, 7ot, 7qc, 7ma, 7no, 8bbf, 8cci, 8cde, 8cko, 8dae, 8cy, 8es, 8gh, 8kc, 8vv, 9abc, (9acx), 9aec, 9aic, 9aqc, 9amb, 9and, 9bav, 9bdj, 9bic, (9bis), 9bjk, 9caj, 9ccw, (9cea), 9cht, 9cju, 9cjj, 9cly, 9cwj, 9dai, (9dfh), 9dmx, 9doe, 9dre, (9dte), 9dwn, 9dxm, 9dxq, 9dzo, 9eak, 9eam, 9eea, 9eld, 9ekf, 9ap, 9bk, 9hm, 9rc, kdkk, wgy.

Can.—3ni, 4ab, 4cb, 4cr, 4cn, 4dq, (4fz), 4ss, Mex.—(bx). Those hring 6CIX pse qsl. All crds promptly ansd.

Continued on page 71



# FADA

## Transformers and Variable Condensers

FADA Audio Frequency Transformer No. 171-A, \$6.00

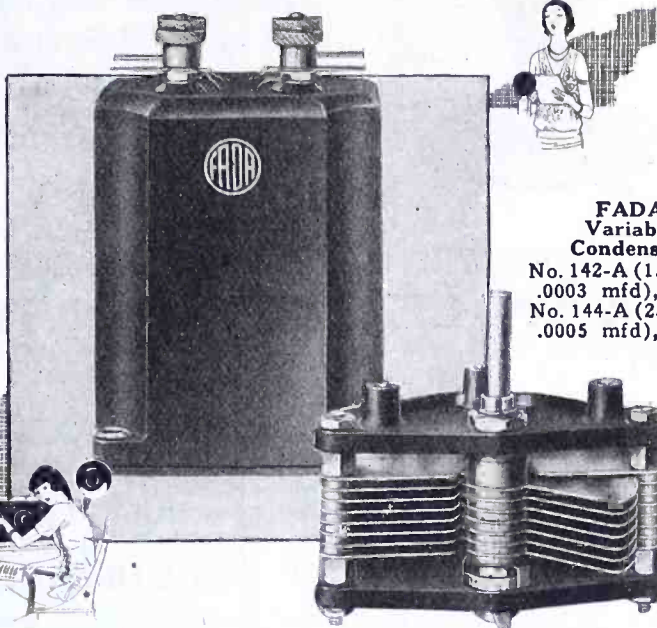

FADA Variable Condensers No. 142-A (15 plates .0003 mfd), \$3.00 No. 144-A (23 plates .0005 mfd), \$3.50

### More volume—finer tuning

POOR condensers absorb radio power—that cuts down volume. Poor condensers add resistance—that broadens tuning. You can sharpen your tuning, increase selectivity and get greater volume with the new FADA “low-loss” variable condensers. Use them. The low power factor and low equivalent series resistance prove their superiority. FADA “low-loss” condensers are more efficient than many of the so-called precision condensers and have a capacity ratio of 40 to 1 as compared with 30 to 1 which is usually encountered. Two sizes—No. 142-A (15-plate .0003 mfd) at \$3.00 and No. 144-A (23-plate .0005 mfd) at \$3.50.

### Performs as well as it looks

The new FADA Audio Frequency Transformer is encased in bakelite with nickeled binding posts and soldering lugs. It looks “quality” all over. And it performs up to its appearance. It has a high average amplification over all the broadcasting wave-bands and reproduces voice and music with a volume and tonal fidelity that is surprising. A wonderful addition to the audio frequency stages of Neutrodyne receivers and equally efficient in other types. This new transformer, No. 171-A, is made possible by correct FADA engineering principles and by uniform production methods. Ratio 4 to 1. Price \$6.00.

Ask your dealer for FADA Transformers and Variable Condensers

F. A. D. ANDREA, INC., 1581 Jerome Avenue, New York



Tell them that you saw it in RADIO



## THE Van-Le Reproducer Electric Lamp Type

An entirely new and radical departure in the amplification of sound waves. Big improvement over Horn Type of Loud Speaker. All throaty tones eliminated. Sound waves carry equally to every part of room. Made in three types: Electric Lamp (as illustrated), Fruit Bowl and Cabinet.

Ask Your Dealer or Write Us

DEALERS WRITE FOR SPECIAL PROPOSITION  
**VAN-LE CORPORATION**

100 Sip Avenue,  
Jersey City, New Jersey

Write for a copy  
today



A new twenty-four page booklet will be sent, gratis, to those interested in building their own receiving sets.

A simplified method of construction is described. Illustrations and diagrams.

On Request

EISEMANN MAGNETO CORPN.  
William N. Shaw, President  
165 BROADWAY, NEW YORK

### A BUFFALO RADIO FAN GETS LONDON WITH THE HELP OF A **KIC-O**

Mr. E. C. Lewis on March 18th, heard Mr. Marconi's voice on a Model 10 Atwater Kent Machine. He said it would have been impossible without a KIC-O Battery. Improve your set with a KIC-O. Our guarantee protects you.

#### GUARANTEE

Your money back on any KIC-O Battery if not satisfied within 30 days' trial.

Write for full information on "A" and "B" Batteries.

Volts	Price, Plain	With Panels
22	\$ 5.50	.....
32	7.25	\$11.75
48	9.50	14.00
68	12.50	17.00
100	17.50	22.50
145	23.50	28.50

Unmounted Rectifier \$1.00  
Mounted Rectifier . . \$2.50

**KIMLEY ELECTRIC COMPANY, Inc.**  
2661 MAIN STREET BUFFALO, N. Y.

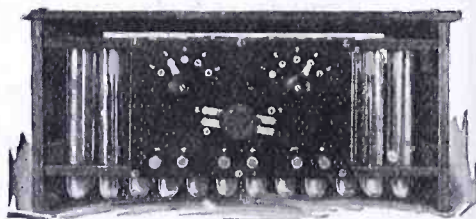

100 VOLT TYPE

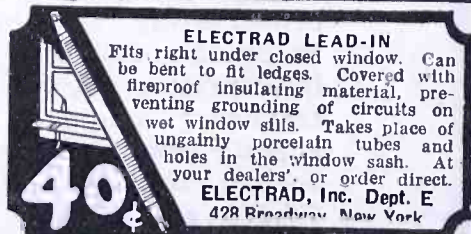

### CRESCENT LAVITE RESISTANCES

Absolutely Non-inductive

12,000 Ohms  
48,000  
50,000  
100,000



List \$1.50

Special Sizes to Order  
Used in all Circuits. Dealers write for discount.  
CRESCENT RADIO SUPPLY CO., 5 Liberty St., Jamaica N. Y.

### SHORT WAVE TRANS- MISSION

Continued from page 12

with a fair degree of reliability which were only occasionally reached on long wavelengths. Furthermore the signals are transmitted so clearly and with such volume that it is possible to rebroadcast them 3000 miles away. On several occasions all eight stations of the British Broadcasting Company relayed WGY's broadcast programs. The most successful experiment was that of April 5 when an entire program of organ, tenor and trumpet solos and an address, was carried by wire from the Wanamaker auditorium in New York to the transmitter of WGY in Schenectady. This entire program was sent out on 107 meters and also on 380 meters and the signals on the former wavelength were picked up and relayed by the British stations. According to a radiogram received from London during the progress of the program the transmission was: "all as clear as if played in London." The short wave signals from WGY have also been heard consistently in Los Angeles with loud speaker strength on only two tubes and this at times when daylight covered the western half of the country. Tests have shown that the signals are remarkably free from the fading which is experienced on the longer wavelengths.

While the design of a short wave transmitter is similar to that of any broadcasting set, the enormously high frequency involved—2803 kilocycles—requires the use of some unusual and novel apparatus. The antenna is of the fan type, but it differs in some respects from the conventional antenna. In order to decrease resistance losses its conductors are made of 3/8 in. hemp, over which is braided many fine strands of bare copper wire. The two wooden poles supporting the antenna are much larger than necessary to support a structure of this size but they are essential to prevent the antenna from swinging. Swinging antenna results in frequency change.

The building sheltering the transmitter is located a short distance to one side allowing the counterpoise to come directly underneath the center of the antenna, greatly increasing the radiating efficiency of the system. The antenna is 80 ft. high and 60 ft. in width at the top part of the fan. It has a fundamental of 160 meters.

To secure maximum radiation the transmitter is located on level ground, a mile from the nearest building.

The oscillating system is of the conventional coupled-type in which the frequency is controlled by a tuned circuit rather than the antenna circuit, this greatly eliminates the possibility of frequency change due to the swinging of the antenna in the wind. The primary coil consists of 1 1/2 turns of copper ribbon

We Repair

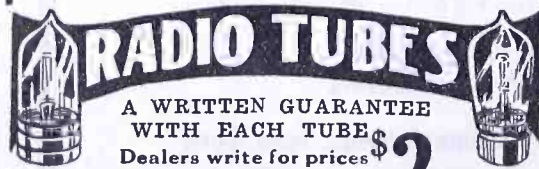

## RADIO TUBES

A WRITTEN GUARANTEE WITH EACH TUBE  
Dealers write for prices

\$2.50

RADIO TUBE MFG. CO.  
154 Nassau St., New York  
Mail Orders Promptly Filled. All Makes.

Tell them that you saw it in RADIO

2 in. wide and this is tuned by an air condenser made of aluminum plates 3 ft. square. In solving the problem of a plate spacer that would not break down, the use of very thin hard rubber strips was decided upon. Power tubes are of the water-cooled type and are connected through a pump to a large radiator which insures an uninterrupted water supply. The entire unit is suspended on springs.

The modulator tube is water-cooled and it is connected to the same cooling system as the oscillator. The speech power amplifier is a 250 watt radiotron, and, because of the intense field from the oscillator and its associated apparatus, it is shielded by a copper box to prevent regeneration and the resulting loss in quality. All wires connected to the amplifier are shielded and the lines to the studio and control room are covered with lead and are buried to prevent the radio signal from getting back into the input circuit.

The plate power supply to the water-cooled tubes is a three phase, full wave rectifier capable of supplying 30 kilowatts at 15,000 volts. Filaments are lighted by special direct current machines to eliminate the ripple which results from the use of alternating current on tubes employing a high filament current.

**PLATE-TUNED REVAMPED**

*Continued from page 29*

the grid condenser is the one really needing the vernier.

Tuning is not difficult as the beginning is made by lighting the tube till the set oscillates and setting the switch in the middle; after that tune with the condenser and variometer for the whistle and clear up for the music. Final adjustment is made with the switch and two dials for maximum volume, after which, generally, the switch can be left set for tuning, reducing the controls of the set to two. For elimination of interference the switch is turned to minimum to give maximum selectivity and then increased until you are getting the station you want clearly and have gotten rid as much as possible of the interferer. It is usually easily possible to receive through local stations with this set. On static days reduction of the switch will usually help a great deal to allow reception when impossible on a single circuit set.

**NEW RADIO CATALOGS**

The Alden Manufacturing Company has issued "What to Build," a booklet showing diagrams and information for several selected and tested circuits using from one to five tubes. Among these circuits are the Neutrodyne, Reflex, Superdyne, and a two-stage amplifier. The price is 15 cents.

Bulletin No. 10 from the Roller-Smith Co. illustrates and describes their small size instruments for radio control panels. These include d.c. and a.c. ammeters, milliammeters, voltmeters and milli-voltmeters for either flush or surface mounting.

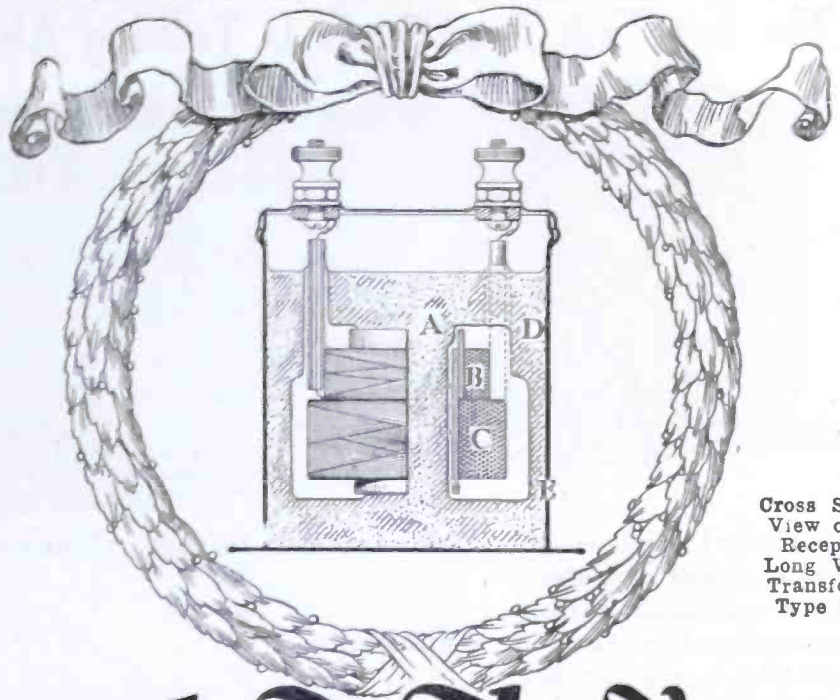

Cross Section View of the Receptrad Long Wave Transformer Type 1716

# Laurels To The Victor!

The design of a perfected intermediate frequency amplifying transformer for use in Super-Heterodyne or long wavelength amplification is a task calling for unusual engineering skill. In the type 1716 developed by RECEPTRAD engineers, it will be seen that unusual skill has been displayed in solving this most important unit in Super-circuits.

The special core A, is of comminuted iron and forms a closed field. The primary B, is so wound with respect to the secondary C, that it affords the maximum step-up in signal voltage. Both are "Herring Bone Winding," a patented type used only by Receptrad. The field is further shielded by a magnetic path D, and is metallically isolated from external fields by the case E.

The RECEPTRAD transformer is a victory for the steel core type but a greater victory for Receptrad because its efficiency exceeds by far any similar intermediate frequency coupler.

*Further Engineering data sent on request.*

**Other RECEPTRAD Super Parts:**

- THE SUPER-HETERODYNE MANUAL**, by Lieut. Victor Greiff.....\$1.50  
Written by Victor Greiff, giving the fullest details and explanations on theory and practice. Includes three full size blue prints for panels, drilling, circuit, etc. The only complete and authoritative text book on the subject.
- TRANSFORMER, TYPE 1716, LONG WAVE**.....\$8.50  
Used in the Intermediate Frequency Amplifier. Covers frequencies from 5,000 to 25,000 meters. Self shielding. Steel core guarantees power and stability.
- OSCILLO-COUPLER, TYPE SW-21**.....\$6.00  
Covers wavelengths between 200 and 750 meters.
- FILTER-COUPLER, TYPE H-34**.....\$7.50  
Special construction, Herring Bone Winding, Sharply Tuned.
- TRANSFORMERS, TYPE ATX AND AT3**.....\$5.75  
High efficiency—clear toned for 1st and 2nd step audio.

*If your dealer cannot supply you, forward remittance and you will be supplied direct.*



**RADIO RECEPTOR CO.**



57 Bank Street

New York City

## A Wonderful Soldering Iron!!

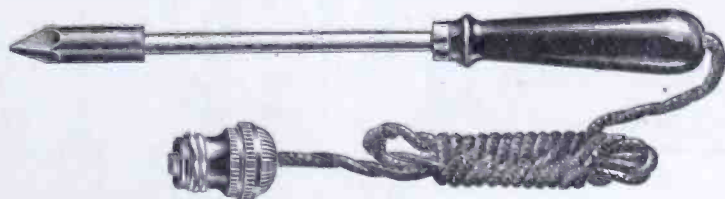

PRICE  
**\$2.50**  
EACH

This "Live Heat" soldering iron will practically last forever. Forged copper tip, and indestructible heating element that gives you a hot tip—just what you want.

We guarantee it, or money back.

**THE HARTFORD INSTRUMENT CO., 309 Pearl St., Hartford, Conn.**

Coast Rep.: F. L. Tomlinson Co., 447 Pacific Bldg., San Francisco  
1111 Wall St., Los Angeles

Tell them that you saw it in RADIO

## The Set That Everybody Is Talking About

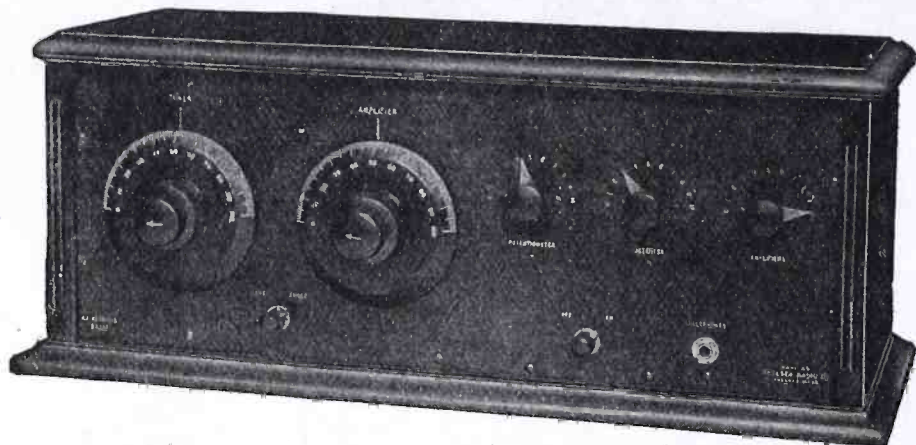

It has a loud speaker range of from two to three thousand miles.  
 It is extremely selective.  
 It gives enormous volume.  
 It reduces re-radiation to a minimum.  
 Its quality is unexcelled.  
 It is simple to operate.  
 It has that essential pleasing appearance.  
 It is fully guaranteed.  
 It requires a small antenna and with such, will give results equal to, or better than the average five, six or eight tube set now on the market.

**PRICE \$75.00**

**CHELSEA RADIO COMPANY**

179 SPRUCE STREET

CHELSEA, MASS.

Western Agents—Frederic L. Tomlinson Co.

447 Pacific Bldg., San Francisco

423 Homer-Laughlin Bldg., Los Angeles, Cal.

## WHAT MUSIC THE PUBLIC WANTS

*Continued from page 16*

Maria," Bach's "Air for the G-string" (not originally a violin solo), and the Bach-Gounod "Ave Maria" (this last, most curiously, a song-melody by Gounod super-imposed upon a Bach Prelude which is better music by itself, though the mass-public will never be taught to think so). Ear-filling tunes, assuredly!

Such popular classics are the "best-sellers" of music. They are not popular merely with the rather wide fringe of musically semi-educated folk who go to concerts and become amateurs of music, but are universally popular. They are the staples, the backbone of the music trade in all its branches, just as Shakespeare, the Bible, Dickens and Thackeray are the backbone of the book-trade. In the long run they may pay better than jazz, whose profits are often feverish, but often lacking. The general public has no idea of how easily huge sums can be wasted on popular songs that misfire.

All this, however, is in line with our previous suggestions. People whose musical appreciation is still on the motor-sensory plane, it has been shown, may speedily reach up to the point where their ears demand something more than the pretty tinkles of jazz; their feet something more than the undeviating tom-tom-tom-tom of popular dance music. They reach up to the fuller harmonies of the Sextette from "Lucia" or the subtler rhythmic graces of Chopin or Mendelssohn.

In the same way, those who love the cruder ballads, or story-songs and sentiment-songs, frequently want something better along the same lines—hence the English ballad-song or "drawing-room ballad." John McCormack understands this better than any living singer, and has said, time and again, that his success has been achieved by singing "good" ballads. That is, songs in which the words express a true idea or sentiment, such as "I Hear You Calling Me," in which the music measures up to that standard and heightens the words, though it may not be of the very best Schubertian excellence.

The logical development of the ballad is the old-time ballad-opera, or opera of the mid-nineteenth century such as "Il Trovatore," "Rigoletto," "Faust" and "Carmen." Here music, words, action and stage-setting unite to heighten the effect. Even when the action and setting are absent, as with the radio or phonograph, some of the operatic "glamor" remains and the music is more intense. Grand opera of this kind is the easiest form of "good" music to popularize.

In the hope that broadcast managers may have read thus far, and found a few ideas of value, may we conclude



# SIGNAL RADIO CABINETS

Signal radio cabinets have been purchased by the big majority of set builders.

Built by radio engineers, they have all the elements that appeal to the average builder and meet all his requirements.

Ask your dealer.

TYPE "B" CABINET

## Sizes and Prices

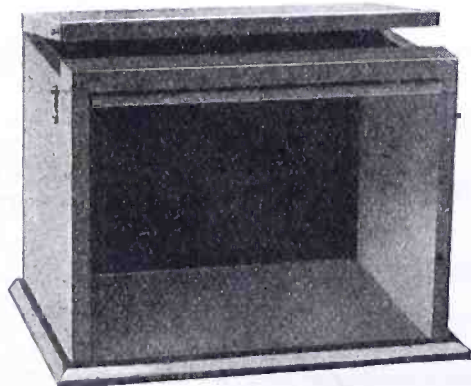

Height	Width	Depth	Regular List Price
7	10½	7	\$3.39
7	12	7	3.57
7	14	7	3.83
7	18	7	4.33
7	21	7	4.71
7	24	7	5.09
7	26	8	5.56
7	30	8	5.94

**SIGNAL Electric Mfg. Co.**

Factory and General Offices:  
 1913 Broadway,  
 Menominee, Mich.

Los Angeles  
 Boston

Chicago  
 Philadelphia

Minneapolis  
 Montreal

New York  
 Pittsburgh

San Francisco  
 St. Louis

Seattle

Toronto

Winnipeg

Havana, Cuba

You'll find our local address in your Telephone Directory.

Tell them that you saw it in RADIO

with a suggestion or two? Variety is the spice of life, and a regular evening's "amusement" program (the specific dance program apart), should include all three of the popular forms of music: Music that is either jazz, or has the rhythmic "punch" and variegated colors of jazz (as in light opera); plenty of story-ballads; and a fair share of the popular classics. And the program should have balance. Every number should lead up to, or away from, something big. That will hold the listener-in.

Radio artists, especially the best, often object to doing what is "hackneyed" or "popular," even though it is of classic origin. They forget that what is old to them is new to many who never heard it.

By all means, of course, include also those admirable programs which are strictly classical, drawing upon unfamiliar works of Bach, Mozart, Schubert, Schumann, Debussy and the moderns. Many music "nuts" (including the writer) are investing in radio equipment entirely on their account, and we, too, have our rights. But such programs will attract ever-wider following if the unthinking masses are given a chance to step up by way of the "hackneyed" popular classics. By all pedagogical precedent, the way to the unknown is by way of the known. The popular classics have established themselves. Their universal popular quality has been proved by experiment, and has often existed definitely over centuries. They will not fail to exert their old charm upon a rising generation of uncounted millions to whom the higher graces of music are still unfamiliar.

ISN'T IT THE TRUTH?

By C. V. BARTON

The first attacks of radio  
 Had no effect on me;  
 But it was well I did not know,  
 And could not then foresee,  
 The changes time would make. I felt  
 Insidious desire  
 My inhibitions slowly melt.  
 At last I got some wire,  
 A paper tube, a dial, a knob,  
 Some sliders and a bit  
 Of silicon—I found the job  
 Would tax my brains a whit.  
 Then when at last the thing was done  
 Successfully, I swore  
 I'd never make another one  
 Nor tinker any more.  
 I've lived a hundred years since then  
 And now I celebrate  
 So agilely it shames me when  
 That set I contemplate.  
 This now the fulcrum of my schemes,  
 This some day shall be mine—  
 Concrete projection of my dreams—  
 A superheterodyne!

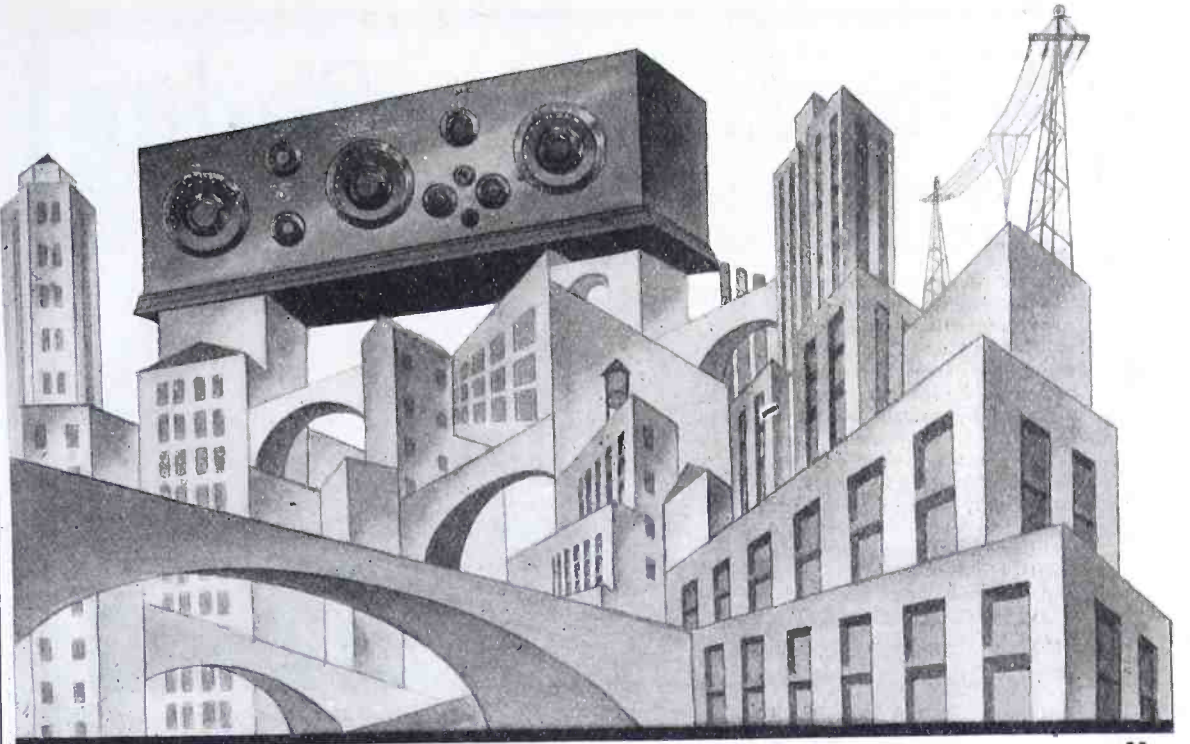

STEEL IS NO BARRIER

Sky-scrapers and thousands of tons of steel may rear themselves to the skies, yet the Melco Supreme Tuned Radio Frequency Receiver nestled deep among these recognized radio barriers still retains its marvelous long-distance reception. Even with high-powered stations broadcasting nearby, the Melco

Supreme will bring in the same long distance without a fractional lowering of the quality or volume of its superb tone. Marvelous though its performance under such severe conditions the Melco Supreme has won its greatest host of followers by its extreme selectivity and simplicity of operation.

SATISFIES EVERY RADIO WISH



AMSCO PRODUCTS, INC.  
 Broome and Lafayette Streets, New York, N. Y.



**RATHBUN**  
 SINGLE-HOLE MOUNTING  
**SUPERIOR CONDENSERS**  
*LEAD by Efficiency and Superior Values*  
 Plain and Vernier Types  
 DEALERS and JOBBERS write!  
**Rathbun Mfg. Co. Inc.**  
 Jamestown, N. Y.

**B-METAL**  
 For reflex and crystal sets it has no equal. The price is your guarantee of quality. Will be with you in August at Frisco.  
**B-Metal Refining Co.**  
 12th floor 525 Woodward Ave.  
 Detroit, Mich.

**AMPERITE**  
 AUTOMATIC FILAMENT CURRENT ADJUSTER  
 FOR EVERY STANDARD TUBE  
 ELIMINATES RHEOSTATS  
 EXPELS ALL TUBE TROUBLES  
 FROM YOUR DEALER OR  
**RADTALL COMPANY**  
 654 GRAND AVE., NEW HAVEN, CONN. \$1.10 WITH MOUNTING

Tell them that you saw it in RADIO

# The Best in Radio

Telmaco Radio Guide Book describes all, 10c.

Our new 64-page Catalog No. TGR contains twenty of the most popular radio circuits printed in blue. These include the Super-Heterodyne, Neutrodyne, Grimes Inverted, Colpitts, Flewelling, Reinartz, Diode Electrad, Super-Regenerative and many others. Each article used in circuits is attractively pictured instead of appearing in straight schematic form. Besides containing blue prints, the best in radio is also illustrated and described. Catalog sent postpaid for Ten Cents. Each circuit worth double.



Send for your copy today.

**DEALERS!** Our New Dealers' Catalog and Price List describes nearly all the better Standard Radio Lines. You should have it. Mailed FREE to all bonafide dealers making request on their business stationery.

**TELMACO**  
Quality Radio Exclusively  
Established 1918

Radio Division  
**TELEPHONE MAINTENANCE CO.**  
20 So. Wells St. Dept. A Chicago, Ill.

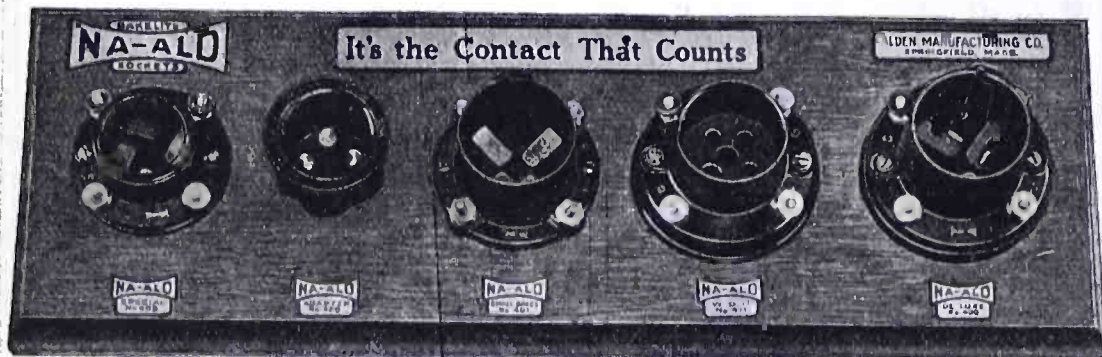

## Look for the socket board

In leading radio stores you will find the Na-ald Socket Board, displaying the five standard Na-ald Sockets: For the 200 and 201 tubes, the De Luxe at 75c, and also the Small Space at 35c. For the U V 199, No. 499 at 50c and adapter at 75c. For W. D. 11, No. 411 at 75c.

Ask your dealer to show you the self-cleaning arrangement of contacts in Na-ald De Luxe, No. 400. These dual-pressure contact strips cut into the sides of tube terminals, keeping their surface clean and bright, and resulting in perfect contact.

These sockets have the highest dielectric properties, obtained by the thorough cure of the Bakelite used, and made possible by uniform cross-section.

There can be no noisy circuits due to poor contact with these sockets in use.

New rotogravure booklet "What to Build" now packed with each Na-ald product. If your dealer's stock doesn't have this booklet send cover of Na-ald carton or 15c for it.

**Alden Manufacturing Co.**

See our Exhibit at the Pacific Radio Exposition. Dept. H SPRINGFIELD, MASS.



UNIFORM CROSS SECTION OF THE NA-ALD DE LUXE SOCKET

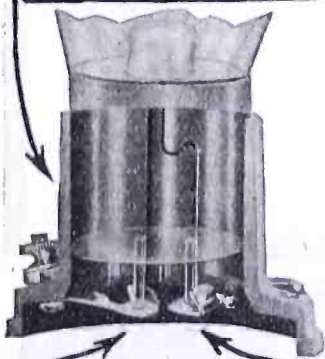

SPECIAL DIPPED BRIGHT PHOSPHOR BRONZE CLIPS, LAMINATED AND EXERTING DUAL-WIPE PRESSURE.

THIS ILLUSTRATION SHOWS HOW THE CONTACT STRIPS CAN BE MADE TO CLEAN TUBE TERMINALS AUTOMATICALLY BY ROTATING TUBE SEVERAL TIMES.

## RADIO SHOW TICKETS FREE!

Subscribe to "RADIO" for 6 months (\$1.00) and we will send you two admission tickets for the Pacific Radio Exposition.

"RADIO," Pacific Building, San Francisco

## A RADIO PIRACY

Continued from page 24

they had brought the *Rosewood* to the rescue before the pirate craft had put in an appearance.

Slowly now the *Rosewood* bore down on the disabled yacht.

"Are we in time to be of service?" shouted Ashbrook from the bow through a megaphone.

A rather oldish man, whom he took from the distance to be Fontaine himself, cupped his hands over his mouth.

"All right, Bender," he replied, "I'll not forget the son of an old acquaintance. You've played your little game and it was smooth, but not quite smooth enough. It's my move now. Watch out!"

He had scarcely finished when there came a puff of smoke from the bow of the *Mercedes* and Ashbrook heard the report of the concealed gun. He felt the *Rosewood* quiver like a frightened animal when the shell struck and exploded. For a moment he stood dumfounded—then suddenly sprang into action.

"Don't!" he screamed through the megaphone, "For God's sake don't shoot again. We came to help you—we're not ———!"

Here he realized it was useless. The decks of the *Mercedes* had suddenly become deserted and even as he stared there came another puff from the gun. This time the shell hit below the waterline, tearing a great hole in the *Rosewood's* side as it exploded. With uncanny accuracy a third shell dropped down the funnel to explode in the engine room, which completed the ill-considered havoc.

Ashbrook turned swiftly to his crew, who were standing dumfounded behind him.

"Quick!" he shouted, "get out the boats. We're sinking. Jeffries you radio our identity to Fontaine and get his help."

Sensing the plight of the *Rosewood*, even though darkness had now fallen, Fontaine had given orders to cease firing, and, as soon as the message was received, left in the first boat to pick up the ill-fated crew of the *Rosewood*. Going on deck of the fast-sinking yacht, he tendered his apologies and regrets to Captain Ashbrook and promised to reimburse him for his loss as soon as they reached Manila.

While both crews were thus busily engaged, Bender and his pirate crew, forgotten for the moment, had come up quietly in the dark and boarded the *Mercedes*, where they quickly overcame the handful of men on the ship and were ready as a reception committee to greet and capture the men in the returning boats as they came on deck. Being taken unawares, Fontaine was an easy victim.

Tell them that you saw it in RADIO



As Ashbrook and Jeffries with three men were delayed for half an hour in leaving the *Rosewood* just before she sank, Bender assumed that he had made prisoners of all the men on both ships and was planning to get the pearls from Fontaine's daughter, who, he suspected, had them concealed on her person. He then intended to dismantle the radio apparatus on the disabled *Mercedes* and get away in his own boat, figuring that Fontaine and his crew would not be picked up until he was far away.

As Ashbrook approached the *Mercedes* he spied the dark hulk of Bender's *El Dorado* alongside and quickly guessed what was wrong. Cautioning Jeffries and his men to wait fifteen minutes before going aboard and then to come at once to his aid, he threw off his coat, leaped into the sea, and, with swift, silent strokes, bore down on the sinister shadow. Several dark forms stirred about the stern and he swam even more cautiously to avoid discovery. A rope dangled from the bow and he pulled himself up on this and climbed aboard, concealing himself behind a wicker davenport that stood near the cabin. Not far from him, but on the other side of the cabin, several of the crew discussed the events of the night, while from nearby came the groans of another, probably a victim of the attack on the *Mercedes*.

As he leaned against the cabin he could hear voices within—that of *Mercedes* and a man who must be Bender. The porthole above him was closed and a blind drawn over it, which however, did not cover the entire opening, and, when it was safe to stand up, he could catch a glimpse of the interior.

*Mercedes*, seated on a couch, was fully dressed, although her hair and clothing were considerably disturbed as though she had put up a struggle. She calmly faced Bender, who stood with his back to the porthole.

"Come now," he was saying, "I'll ask you again. Will you give me the pearls or shall I take them from you by force?"

The girl made no reply.

"You won't answer?" Bender went on threateningly. "I've given you a chance! They're hidden in your clothing and I'll offer again to go out while you get them. But if you don't I'll take them, anyway if I have to search you myself."

*Mercedes* laughed slightly. "I warn you, Bender, don't you try it," she replied calmly.

"Damn you—I will try it!"

Believing the crisis to have come, Ashbrook swiftly got to his feet and grasped his automatic. Through the crevice underneath the blind he saw Bender step toward the girl, who suddenly arose from the couch. He attempted to grasp her arms, but, quick as a flash, her right hand swung from

# BAKELITE

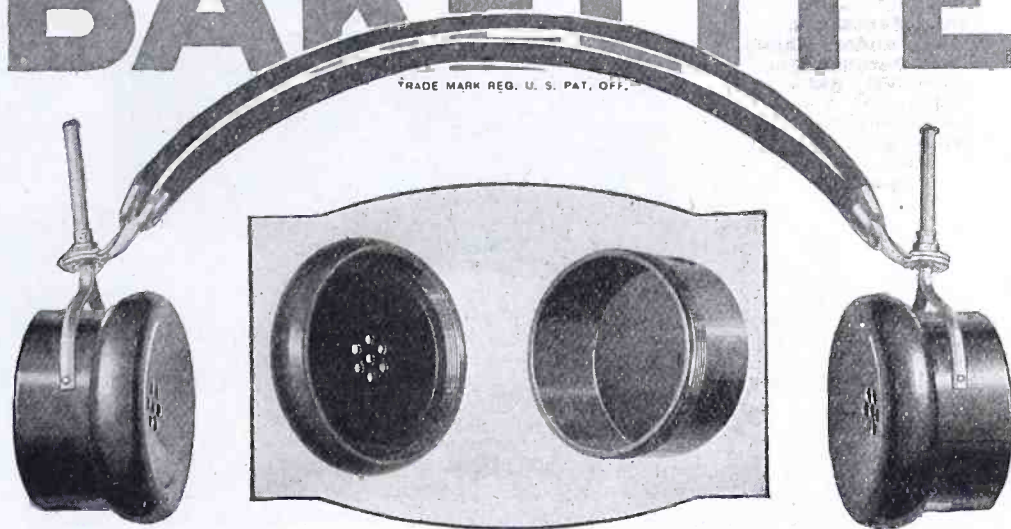

## Baldwin and Bakelite

The clear tone of this popular head-set, made by Nathaniel Baldwin, Inc., of Salt Lake City, has been developed by careful experimentation in every phase of its manufacture, from the selection of raw materials to the final testing of the completed instrument.

Bakelite is used for the receivers because it is strong, and light in weight. After years of service

under varying atmospheric conditions, Bakelite shows no signs of deterioration. Its color does not fade and its fine finish is impervious to oils, acids and moisture.

"The Material of a Thousand Uses" possesses many valuable properties which make it peculiarly suitable for use in radio equipment.

Send for a copy of our Booklet S.



### Send for our Radio Map

The Bakelite Radio Map lists the call letters, wave length and location of every broadcasting station in the world. Enclose 10 cents to cover the cost and we will send you this map. Address Map Department.

### BAKELITE CORPORATION

247 Park Avenue, New York, N. Y.  
Chicago Office: 636 West 22d Street

THE MATERIAL OF A THOUSAND USES

### SPECIALIST IN SUPER HETERODYNE CONSTRUCTION

Complete building and repair service—any type set—  
**Herman E. Erickson**  
(Associate, Institute of Radio Engineers)  
One Union Square New York

### HEAD SETS LOUD TALKERS PHONO-ATTACHMENTS

# TRIMM

RADIO MFG. CO., Dept. 58  
24-30 S. Clinton St. Chicago, Ill.

### Thank Your Favorite Stations—Request Your Favorite Selection

THANK YOU  
YOUR OWN Name and Address Printed FREE On Every Card  
"Thank You" cards are all the rage. Stations appreciate them. A pleasure to use. Be in style. Low introductory price. 100—\$1.65; 200—\$2.60; 300—\$3.50 POSTPAID. Order today.  
MONEY REFUNDED if Not Satisfied  
Good quality cards—High grade printing. You will be DELIGHTED.  
Send order with check or money order today—NOW.  
RADIO PRINTERS, Dept. 55 Mendota, Illinois

### Beat These Wet "B" Batteries If You Can

Rabat Junior (12 cells 24 volts) capacity 800 mil-amps, only, \$3.96; Rabat Senior (2800 mil-amps), \$9.60. Prices F.O.B. Cleveland, Ohio. If your dealer cannot supply you send direct.

The Radio Rabat Company  
814 Bangor Bldg. Cleveland, Ohio

Tell them that you saw it in RADIO

Licensed by Independent Radio Manufacturers, Inc., under Hazeltine Patents Nos. 1,450,080, dated March 27, 1923, and 1,489,228, dated April 1, 1924. Other patents pending.



# The Eagle *Balanced Neutrodyne* "King Of The Air"

THE skill and painstaking care maintained provide a balance comparable, figuratively, with the poise of the soaring eagle. Demands upon quantity production are forgotten in the untiring effort to provide the perfect balance of tube capacities that has made the Eagle the peer of Neutrodyne.

Eagle Neutrodyne cannot radiate nor regenerate. Its remarkable ease of operation makes certain the reception of any station, once logged. As wonderful in simplicity as the phonograph; more wonderful in its volume—clear, loud, actual in tone.

QUALITY FIRST characterizes the Eagle—and prompts the unre-served guarantee.

*We Soar Above*

*Write for Literature*

## EAGLE RADIO COMPANY

17 Boyden Place Newark, N. J.

Pacific Distributors  
SCHWABACHER-FREY STATIONERY CO.,  
609-613 Market St., San Francisco, Cal.

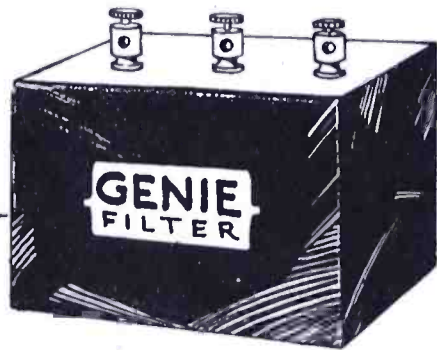

# "Noise Killer" INDUCTION FILTERS

## Given Free this Month

FREE—The new Genie Induction Filter for eliminating induction noises from telephone and power lines, etc. Send us your subscription to "RADIO" for one year, \$2.50, and the Filter is yours. Not another cent to pay. This special offer is made again this month by popular demand. Almost 1000 Filters were given free to our subscribers during the last two months. This is your last chance to get one of these practical and useful instruments. Every radio receiving set should be equipped with this device. Don't be bothered with induction noises in your receiving set. Install a filter. This device was designed by Don Lippincott, Radio Engineer. It is manufactured by the Aerovox Corporation of San Francisco. Send your \$2.50 to us right now and you will get a Filter by return mail and receive "RADIO" every month for a full year.

*Diagram shows simplicity of connection to your set. No tuning controls to bother with. Can be installed in a few moments.*

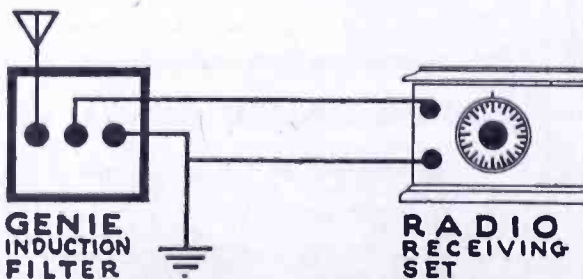

"RADIO," Pacific Building,  
San Francisco, Calif.

Herewith is \$2.50. Send me the Genie Induction Filter at once and put me on your subscription list of "RADIO" for one full year.

Name .....

Address .....

City .....

State .....

behind her back and in its grasp gleamed a tiny blade. It flashed quickly across his face and Bender fell back, his gashed cheek spurting blood.

"Michael - Fu - Wainsworth - help!" he shouted loudly, quickly retreating to the other side of the room.

From the opposite side of the cabin, Ashbrook heard the men suddenly stir. If he were to act, now was the time, and he, too, rushed for the cabin door. The three men had preceded him into the room and he followed, the automatic held before him.

"Stick 'em up!" he cried as he entered and leveled his weapon. When the surprised men had complied, he turned to the girl: "Get back of me, Miss Fontaine and lock the door. You men line up over there by that port-hole and keep your hands high. I'll shoot the first one who moves."

At the moment Mercedes swung the door shut someone grasped it from the outside. Ashbrook partly turned to help her and, as he did so, the man Michael leaped like a cat at him.

Ashbrook's partly lowered arm suddenly stiffened and the automatic crashed. Michael stopped midway in his leap and staggered back clawing at his breast. Slowly he sank to the floor.

"Ashbrook—the Chink!"

Mercedes' quick shout caused Ashbrook to turn in time to see the Chinaman leaping with a knife. Twice he pressed the trigger, but the little gun failed to respond. It was stuck! With a muttered oath, he flung it fairly into the Chinaman's face and the oriental fell back, his battered cheek streaming blood.

Wainsworth and Bender closed in on Ashbrook before he could recover. He struggled fiercely with them while, at the door, Mercedes fought valiantly to hold it closed. The little dagger still gleamed from her hand clenched over the knob and the dark eyes flashed with the fire of a roused tigress.

For what seemed a long time, Ashbrook held his own in the unequal combat. Then the ghastly-faced Chinaman rose and rushed in. Someone tripped Ashbrook's legs from under him and all four went down in a heap. As they fell, Bender's revolver struck him a glancing blow on the side of the head. Faintly he heard a scream of despair from Mercedes, dimly through the meleé saw her step suddenly back from the door and, as two of Bender's crew rushed in, she fell upon the first one, slashing at him with the knife. An instant later he heard Jeffries, then Mayes and McNeal of his own crew—shots from without—another scream—blackness as his eyes irresistibly closed.

Mercedes had beaten off her second assailant when the newcomers entered and she rushed at Mayes, and, before the big second mate of the *Rosewood*

Tell them that you saw it in RADIO

had fully realized her mistake in identity, his right sleeve had been neatly ripped from shoulder to elbow by the little dagger. But, in an instant more, he had grasped her arm and held it while she struggled furiously.

"Hold on there, young lady," he broke in, "You're prodding the wrong man with that knife. We ain't here to hurt you. We just got here from Captain Ashbrook's boat. You look as though you'd done enough fightin' to last a while, so now you just lay off a minute while I help swab decks with what you've left of these fellows."

As he started in on his task, the girl felt suddenly weak, almost sick. Mayes was holding Bender and his disheartened men at bay while Jeffries and McNeal busied themselves with their captain, who lay writhing on the floor. Mercedes ran to them.

"Is—is it really Mr. Ashbrook?" she asked half fearfully.

McNeal looked up surprisedly. Sure it is," he replied brusquely, "Who'd you think it was, Don Quixote himself?"

"I—I wasn't sure," answered the girl, "I thought for a while maybe—maybe he wasn't. He isn't badly hurt, is he? He was so brave—he—he—"

Proving here, after all was over, that she was only a perfectly normal girl, Mercedes fainted.

As she fell in a heap on the floor, Mayes all but forgot his prisoners.

"Good Lord!" he gasped, "Maybe she's been shot and we didn't know it—she acted weak all of a sudden. What if ———."

"Naw," interrupted Jeffries abruptly, "She's only keeled over, Didn't you ever see a woman faint? You just mind your prisoners and I'll get some water and bring her around. Ashbrook's only got a crack on the head, but I guess we'd better take him to Manila and let a doctor look him over. But don't worry about the woman. Fainting does them good on occasions like this. Wonder she didn't do it long ago, but I guess from the looks of things she didn't have time."

At the hotel in Manila there was dancing on the esplanade that evening. Though Ashbrook was up and around, his bandaged head still rang from Bender's blow and he sat in the lobby apart from those on the esplanade. Somehow he only wanted to talk to one—and somehow he felt she would come to him.

He was not mistaken. Mercedes soon found his spot of seclusion.

"I—I don't know whether to thank you first or apologize for ever suspecting you," she faltered. This evening she was no longer the tigress. She was a dark-eyed girl; a very pretty one. "We—dad and I—owe you so much of both. It seems funny now that it's all over—"

# Every Question ANSWERED for only \$1

At last you have under one cover a Complete Radio Handbook

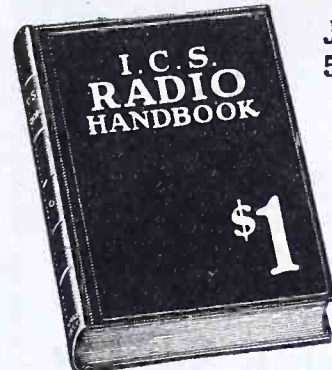

JUST OUT 514 PAGES

Compiled by

HARRY F. DART, E.E.

Formerly with the Western Electric Co., and U. S. Army Instructor of Radio. Technically edited by F. H. Doane.

40,000 ALREADY SOLD

No more need you turn from book to book, hoping to find what you want. It is all here, in 514 pages crammed full of every possible radio detail. Written in plain language, by engineers for laymen. Clears up the mysteries, tells you what you want to know. A complete index puts everything within your reach in a few seconds.

**IT EXPLAINS:** Electrical terms and circuits, antennas, batteries, generators and motors, electron (vacuum) tubes, every receiving hook-up, radio and audio frequency amplification, broadcast and commercial transmitters and receivers, super-regeneration, codes, license rules. Many other features.

**Under one cover.** Yes, it is all in one volume of 514 pages of clear type with hundreds of diagrams and illustrations. Takes the place of eleven or more specialized texts, each costing from two to ten times the dollar you pay for this single book. Belongs in every radio-equipped home, on every amateur's table.

Send \$1 to-day and get this 514-page I. C. S. Radio Handbook—the biggest value in radio to-day. Money back if not satisfied.

TEAR OUT HERE

INTERNATIONAL CORRESPONDENCE SCHOOLS  
Box 8263, Scranton, Penna.

I enclose One Dollar. Please send me—post-paid—the 514-page I. C. S. Radio Handbook. It is understood that if I am not entirely satisfied I may return this book within five days and you will refund my money.

Name.....  
Address.....

## FROST-RADIO

Ask Your Neighbor

No. 140  
**FONE** Plug 60c  
BEST value in a Two-Fone Plug ever offered. Holds fone cord tips under set-screw. Used with two pair head fones or one pair and loud speaker. Get it at your dealer's.

**HERBERT H. FROST, Inc.**  
New York CHICAGO Kansas City, Mo.

Tell them that you saw it in RADIO



# Evenly

in every direction—to every corner of the room—Atlas reproduction sends a clear, rounded, faithful tone.

This is true—with Atlas—regardless of what set you use, regardless of what conditions may be, regardless of what type of program you are receiving. For since these things do vary, Atlas reproduction is provided with a simple adjustment to compensate for variation in receiving conditions.

On local or DX stations, on two tubes or eight, on voice or instrumental music, Atlas floods the room with the best that's in your set. Reponsible dealers everywhere sell Atlas speakers for \$25.00.

Multiple Electric Products Co., Inc.  
36 Spring St., Newark, N. J., Dept. R  
Boston, Philadelphia, Baltimore, Detroit,  
Pittsburgh, Chicago, St. Louis, Denver.  
550 Howard St., San Francisco.

# Atlas

TRADE MARK

## RADIO REPRODUCTION speaker

With the Atlas coupling, complete for \$13.50, any standard phonograph may be utilized to produce Atlas reproduction.

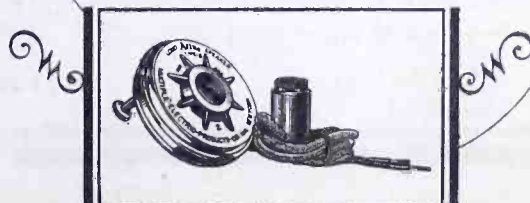

# THOROPHONE

TRADE MARK REG. U.S. PAT. OFFICE

Makes Distant Stations

## LOUDER



High  
Power  
Type  
Model  
S-5  
\$45.00

"The THOROPHONE'S capacity to amplify makes it possible to bring in on the loud speaker distant stations that would otherwise have to be received on the headset," says W. D. Leet, Chicago, Ill.

The THOROPHONE uses a powerful solenoid, whose intense force is added to that of the signals, giving maximum volume of tone.

Second only to the THOROPHONE is the new THOROLA, just introduced to meet the demand for an instrument which does not require a storage battery, but which is built with the same precision as the THOROPHONE. Here you have the same controlled mica diaphragm which gives the finest possible shadings of tone.

Due to the exclusive method of adjustment found only on the THOROLA, together with the Double Push and Pull Principle of amplification, this instrument will reproduce at highest volumes with the same accurate fidelity as at lowest volumes.

THOROLA Three, 12-in. bell horn, \$20  
THOROLA Four, 14½-in. bell horn, \$25

Ask your dealer about THOROPHONE and THOROLA—each the best of its type—or write for booklet.

**Winkler-Reichmann Co.**  
4801 S. MORGAN STREET  
CHICAGO, ILL.



## NO ANTENNA ---Just the Ducon in a Lamp Socket

**S**IMPLY screw the Dubilier Ducon in a lamp-socket — anywhere. Then connect the Ducon with your set. The stations come in strong and clear. No cumbersome outside antenna. Sharper tuning. Less static. Money back if unsatisfactory after five days' trial. Price \$1.50. At all good dealers.

### Dubilier Condenser and Radio Corporation

40-48 West 4th St.,  
New York, N. Y.

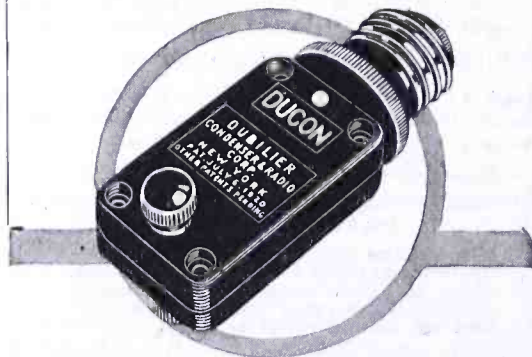

## MU-RAD RECEIVERS

THE ULTIMATE IN RADIO RECEPTION

### R A D I O D Y N E

NO LOOPS — NO AERIAL

Ready for operation by grounding to a water pipe or radiator and throwing a few feet of wire on the floor. Uses any standard tubes—dry cell or storage battery. Extremely selective. Simple to operate—only two controls. Wavelength from 200 to 700 meters. Write for Folder describing this (antennaless) receiver.

WESTERN COIL & ELECTRICAL CO.  
311 Fifth Street Racine, Wis.

Tell them that you saw it in RADIO

doesn't it?" Then she added sympathetically, "I don't suppose it does for you, though. I'm awfully sorry you were hurt."

"Hurt?" Ashbrook was entirely serious. "What does it matter when I've found you through doing it? May I call it the best fortune I've ever had?"

"Not here," said Mercedes a moment later.

"Oh, I forgot," laughed Ashbrook."

So they drew apart into the palms, where the whispering breezes heard another romance of the South Seas.

### THE FINGER OF GOD

Continued from page 30

listening stations. I loved that old 2 KW set of mine; I loved the great game of radio of which it, and I, its operator, were a little part. I wanted nothing—oh, nothing in all the world—so much as that now, at this trying moment, radio should prove itself to be the greatest blessing that modern science had wrought for the safety and well being of the sailor-man.

My call died away. Fearing to miss the answering signal, I cursed the lingering howl of my slowly stopping generator. There was a silence, a terrible silence that brought the beading sweat to my brow, and let my heart go thumping down to a black despair. Was this radio going to fail me now? Was the captain to be allowed another sneer and an "I told you so," when I should report a failure. Rather would I jump overboard than have that happen.

Then—down through the fog choked peril of that well remembered night—came the ringing call of VAV. Just a little jumble of figures and a time group. Next came VAX, nearer and louder, with his QTE. 'Twas the sweetest music that ear ever caught—those drawn out dots and dashes.

After snapping off acknowledgment, and a "thanks" that welled from the bottom of my heart, I rushed to the bridge and gave the captain the bearings. As he hunched over his chart, I could see, by the yellow glow of the night lamp, the skepticism on his face. He did not have faith in this new thing. It was all poppycock to him, and his face showed it plainly. But there was also a worried, hunted expression and an infinite weariness in the eyes. His vessel was in a bad position and he must overlook nothing that might add to her safety. So, he swung his rulers across the chart, drew little lines after repeated looks at my slip of paper. As the plotting progressed, the skeptical look was replaced by one of wonderment. Shoving aside the rulers, he scaled off certain distances with a pair of dividers; jotting down figures, comparing this with that, until, finally he straightened up, his eyes glued to a little dot close in to the irregular line which marked the coast.

"It don't seem possible!" he muttered to himself. "That's almost exactly where I figured her to be. Possibly a bit too close in.—This radio thing must be all right after all. It don't seem possible!"

Leaning over the chart again, he drew a heavy line from the coast out to the little mark.

"That is our true bearing from Chebucto Head, according to the radio," he mumbled again. "That is the course we should make to bring us in.—Provided, Sir —" He turned on me his tired eyes, heavy from sleepless nights on the bridge. "Provided your bearings are correct. They are so close to where I figured, I am inclined to take them. You go down and get me another bearing from Chebucto, and if it checks with this, then I will set a course accordingly. Look alive now!"

The new bearing checked! Needless to say, I was in a seventh heaven of delight. Those weary watchers on the bridge were naturally a good bit doubtful of the accuracy of the bearings. Their close lookout and the constant listening for rumble of distant breakers never ceased. They would step into the chart room, look long at the black line we were traveling down, and then shake their heads in half disbelief as they went to take their places on the bridge again.

But the radio did not lead us astray. Some eighteen hours after we turned southward the lookout picked up the distant growl of the fog-horn. Dead ahead it was! After another hour of slow headway, we ran out of the fog bank, and there, rising full ahead, lay the highlands of Chebucto Head, with the Narrows leading up to Halifax, to the north of the point.

Oh, the radio bearing is a simple thing—to the technical man. Anyone of a myriad army of amateurs can tell you all about the workings of the radio compass. There is truly nothing supernatural about it all. But still! I cannot seem to lose that feeling of awe which came over me that fearsome night when I received my initiation to the QTE. Sitting out here in a world of swirling grayness; lost, helpless and blind; it always seems to be more than something man-made that answers my call for guidance. The *thing* which reaches out so unerringly and says, "There you are"—that which blazes the trail of safety through so many dangers seems to me to be more fitly called—The Finger of God.

**Amplion** THE WORLD'S STANDARD LOUD SPEAKER

WM. JUSTICE LEE  
JACKSONVILLE, FLORIDA  
P.O. BOX 378

March 7th, 1924.

The Electric Specialty Co.,  
Stamford, Conn.

Gentlemen:

You will be interested to hear of the results obtained from the type 11-A 1000 volt, 300 watt motor generator set purchased from you thru the Chase Co. Jacksonville.

This little generator operating at Radio 4XE, has furnished the plate current for 2-way communication with amateur stations in Canada, Porto Rico, France and Holland. When you consider that such a distance of over 5000 miles can be spanned with a power supply of actually 350 watts, (10% overload) and that this motor generator set does the work in first class manner, it seems quite remarkable.

We believe the Esco generator to be the best and most conservatively rated of any we have used to date.

You may use this letter if you please.

Yours truly,

Cooper and Lee  
Owners of Experimental Station 4XE

WJL/MP

*By W. Justice Lee*

TRADE "ESCO" MARK  
*Quality always Supreme*  
ELECTRIC SPECIALTY COMPANY  
STAMFORD, CONN., U. S. A.

*Amplify the MODERN way!*

"Push-Pull"  
"Reflex"  
Standard Audio  
Transformers

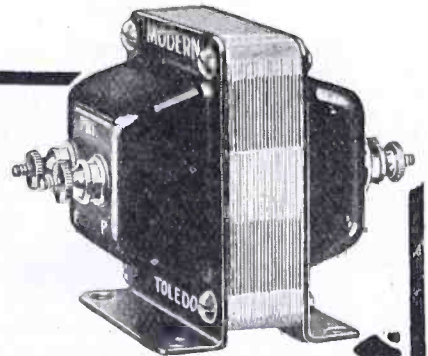

To be absolutely sure of the best results from power amplification, ask your dealer for the MODERN Transformer you need.

**Pacific Coast Distributors**

**LOS ANGELES**  
Globe Accessories Corp.  
Leo J. Meyberg Co.  
Newbery Elec. Corp.  
The Wholesale Radio Elec. Co.  
The Electric Corp.  
The H. Earle Wright Co.

**PHOENIX, ARIZ.**  
Nielsen Radio Supply Co.

**PORTLAND**  
Lectro Mfg. & Sales Co.  
Radio Electric Corp.  
Stubbs Elec. Co.  
The Hunter-Walsh Co.

**SEATTLE**  
The Electric Corp.  
Wedel Company.

**SAN FRANCISCO**  
Alexander & Lavenson Electrical Supply Co.  
Electric Appliance Co.  
Frederick H. Thompson Co.  
The H. Earle Wright Co.  
United Radio Supplies Co.  
Wholesale Electric Co.

**CALIFORNIA SALES OFFICE**  
1113 Wall St., Los Angeles.  
Frederick L. Tomlinson Co.,  
447 Pacific Bldg., San Francisco.

**Modern "Push-Pull"**

Used in addition to one or two stages of audio. Assures clearer and better reception than has heretofore been secured from audio frequency reception.

**Modern "Reflex"**

This is the transformer that makes one tube do the work of three in the Monoflex circuit. Ask for bulletin on the Monoflex Circuit.

**Modern Standard Audio**  
4 to 1 ratio

Designed especially for use in 2-stage amplifiers. Provides greater audibility than three stages using ordinary transformers.

**FREE BULLETIN**

Write for new MODERN bulletin giving simple and complete instructions covering latest hook-ups. Bulletin sent free on receipt of dealer's name.

**DEALERS**

You're overlooking good profits if you haven't stocked MODERN Transformers. Order today from any of the jobbers listed at the left.

The Modern Electric Mfg. Co.  
Toledo, Ohio

Tell them that you saw it in "RADIO"

## FLERON Radio Specialties

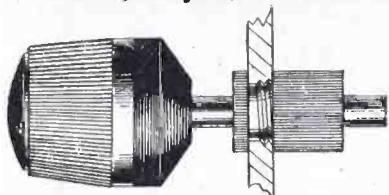

### THE VERNIER ADJUSTER

The best adjuster on the market. Spring holds head away from dial when not in use. With slight adjustment spring can be made to hold head against dial if desired. Patented. 65c.



### THE PORCELAIN INSULATORS

Lowest power losses in the antenna. Dielectric absorption reduced to minimum because of very low phase difference of Fleron Porcelain. Very tough body. Solid Black Glaze. Seven sizes, 20c. to \$1.00. Each insulator in a separate carton.

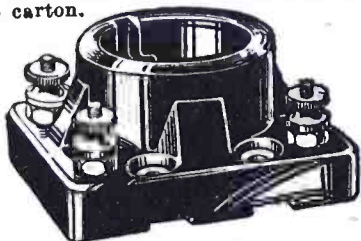

### THE PORCELAIN SOCKETS

Very carefully made. Brass parts nicked. Black Glaze. Two sizes. Standard Bulbs and U. V. 199. Each socket in a carton. 35c. each.

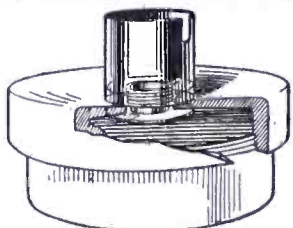

### THE PHONO ADAPTER

Fits through the hole of the receiver cap and then slides on the phonograph tone arm. Fits Victor, Columbia, and others. Works perfectly. Only 35c. ea.

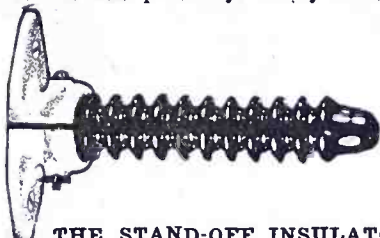

### THE STAND-OFF INSULATOR

Fills the much-needed requirement for a good, strong looking and practical stand-off insulator. Meets every requirement of the Board of Fire Underwriters. \$1.25 each.

For Sale by all Good Jobbers and Dealers

**M. M. Fleron & Son, Inc.**

110 North Broad St., Trenton, N. J., U.S.A.



"REFLEX SPECIAL" QUICK CONTACT RECTIFIER GUARANTEED \$1.00

The Acme Apparatus Co. says "prevent distortion and howling by using a BROWNLIE CRYSTAL in REFLEX SETS." Order From Your Dealer or Direct ROLAND BROWNLIE & CO. 24 Saunders Street, Medford, Mass.

## Write for New Bulletin

Just off the press. Contains information on battery maintenance, station calls and wiring diagrams for basement installation of batteries.

### F-F Battery Chargers

charge a battery for about a nickel. Simple and durable. Type AB charges 2, 4 or 6-volt "A" or auto battery, and "B" batteries up to 120 volts at one time. Type 6 charges Radio "A" and auto batteries.

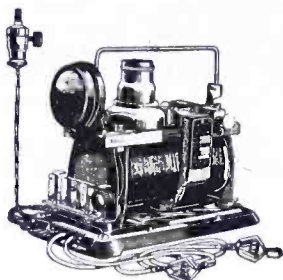

Write for Bulletin, complete information and prices.

### THE FRANCE MANUFACTURING COMPANY

10433 Berea Road, Cleveland, Ohio  
London Office:—24 Maddox Street  
Melbourne, Australia, P.O. Box 1727

## A Pleasant Surprise Awaits the User of the A.C.H. Sharp Turner Dials

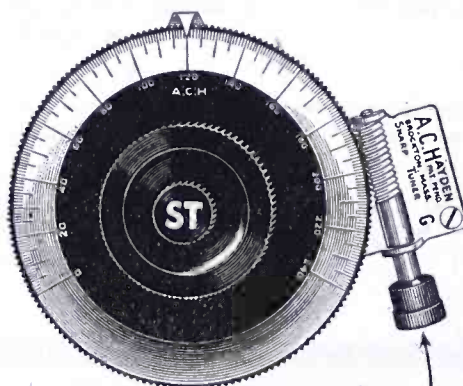

### Why the A.C.H. is different

3 in. DIAL → A.C.H. → 156-T0-1

4 in. DIAL → A.C.H. → 215-T0-1

Will improve any receiving set, making difficult tuning easy

### Money Back Guarantee

Price 3-inch size . \$2.50 Price 4-inch size . \$5.00  
Regular fitting 3/8 shaft 1/4 and 3/8 . . . 5c each extra

### Extra Advantage of the A. C. H.

1. Can be attached or removed from any instrument.
  2. Rough tuning same as any dial.
  3. Movement so fine that the eye cannot detect but the ear can.
  4. Automatically locks instrument so no jar can disturb it.
  5. Dial grounded reducing the body capacity to a minimum.
  6. Special dial 2 graduations where ordinarily one.
- Mail Orders sent Prepaid in U. S. A.

A. C. HAYDEN RADIO & RESEARCH CO.  
BROCKTON, MASS., U. S. A.

Write for complete illustrated FREE Catalog of

## PARAGON

Reg. U. S. Pat. Off.

### RADIO PRODUCTS

Adams-Morgan Co., 2 Alvin Pl.,  
Upper Montclair, N. J.

Pacific Coast Representative—Paul Sutcliffe,  
Rm. 400, San Fernando Bldg., Los Angeles

Tell them that you saw it in RADIO

## LETTERS FROM A "LID"

Continued from page 35

here. Although I might humorously allude to the dinner bell as the "Hash Hammer," Boys, we has something besides hash to eat.

Mabe a little detailed description here wouldn't be aside from proper.

The Captain of course occupies the head seat and I don't think he is a bad guy, though kind of ignorant. You know the kind; good natured and all that, but nothing much sequestered up above. Plenty of volts and no amps. The first question he asks is, "Is you going to get us any press, Sparks?" (Sparks is my title.)

Well I don't tumble exactly to what Press is, but I figures I'll make a good impression, and then bid my time.

"Sure, every hour," I says.

Pretty soon I'm rewarded when a engineer (they is engineers and mates besides Me and the Captain), says that hes interested in Base Ball totals in the press, and then I knows, and rightly, that Press is only newspaper clippings. Which demonstrates, fellows, that its always best to keep a cool head, when you gets in a warm place.

But to get back to the food, often good-naturedly referred to as Chow, I'll detail what we has the first meal so you'll get the idea.

- 1st—Salad (composed mostly of green stuff).
- 2nd—Soup (of a sort of mixed nature).
- 3rd—Mutton Stew (liberally amalgamated with green peas).
- 4th—Potatoes (fried).
- 5th—Peaches (formerly canned).

The comments, of course, is my own.

But all good things must end, as the saying is, and I'm leaning against the railing, leisurley picking my teeth when a engineer draws near. I surmises correctly by his greezy clothes hes a engineer.

"Been to sea before?" he asks gently.

"Sure," I says. And then to let him down I adds, "when I'm eight years old."

He eyes me with suspicions, but its true fellows. Mabe I never tells you, but when I'm eight years old, or thereabouts, my grandmother takes me on a sea voyage for quite a distance, I forgetting where, it being such a long time ago.

"Where you from?" he questions, changing the subject around.

"I originated near Hammerhandle Canyon," I says, "but more recently I been going to school in a Georgian town. "Where do you call home?" I continues.

"New York," he says indefinitely.

"City or State?" I volleys back.

"Both," comes the answer, and we both laughs.

Which puts us on a firm footing together.

But fellows I must needs now inform

you of the tragical part of my first voyage at sea. If some jew fellow, you know the kind, comes along (past tense) about the time we get fairly out on the ocean's bosom, which happens when I gets on a firm footing with the engineer, with a piece of old mother's soil just big enough to stand upon, he wont have to call into play much of his racelike shrewdness to trade it for my license, which you fellows to a man knows I sweats so many months to get and gets turned down the first time on account of a bone-head corrects the papers. I simpathizes why the other guy quits right then. I feels like if I can only get on dry earth I can fairly grovle in it. My land attracted lower extremes aches to be attracted again, and I hates the sights of anything connected to a ship.

And then to tip it all off fellows, the Captain has the exalted nerve to come around with a message to send off, and me laying there on the shelf-like bed as sick as a rumatic guy with chicken-pox just before being hung for some great sin.

He lays the message on the desk and says, "Send this in Sparks." (Thats one thing I takes to him for, he always addresses me by my title.)

Well fellows you know, I'm too ill for words, and I just glares at him with glassy eyes.

When hes gone I'm wandering to make the effort or lay back, and I thinks of old Bill Shakespeare, the former English writer, and his famous, to do or not to do. Its in the tragical moments that the really great authors comes to us.

So I concludes I'll gamble, if I throws up a even number of times in five minutes I makes the effort, odd number, visa versa. Well fellows its six, so I makes the effort.

I weekly looks up a favorable land station in the book of calls, and followed after a long call I lets him have it about 30 per with my snappy fist you fellows know so well.

Well I don't give him much time to answer back for I feels better horizontally stretched, and I retreats to the bed, but some ham says who? like the owl he is, and a lot of others say question marks like they is astonished and I guess mabe its because I'm sending so fast for them. I figures if he don't get it thats his bad luck, and none of mine, I sends it don't I? It might teach them to put shore operators on watch at shore stations what can garner in 30 per for I'm since knowing they is all a gang of hams of the worst water.

I got a date tonight with that frow (Oh Boy), and I'll tell you more in my next but I got to sign off now. Envy me fellows.

Yours truly,

(signed) Henry Speedwell Mosdike, Op'r in charge of Steamship Kekoskee.

**Fibroc Qualities**  
 SILENCE  
 STRENGTH  
 DURABILITY  
 VERSATILITY  
 INSULATION  
 if you... if you... if you...  
**FIBROC BAKELITE**

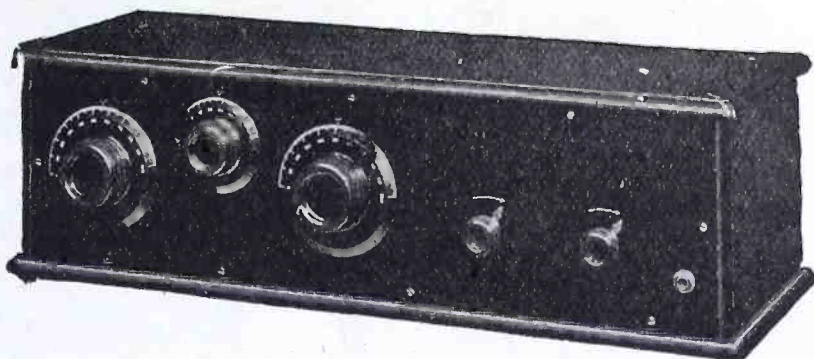

## Your set deserves FIBROC-BAKELITE

Time, labor and money are tied up in the set you build. Give it the sort of panel it deserves, a FIBROC-BAKELITE.

FIBROC-BAKELITE panels are made in black or brown with either a high lustrous polish or velvet surface.

FIBROC-BAKELITE will not absorb moisture and consequently as-

ures freedom from short circuits and distortion.

Manufacturers of radio sets of the highest quality use FIBROC-BAKELITE panels. Good radio dealers sell them in standard sizes, each packed in separate envelope. Look for the name on the package.

Write for information on the further uses of FIBROC in the Radio field

**Fibroc Insulation Co.**  
 255 Lincoln Ave. Valparaiso, Indiana

Built up to a high Standard  
 not down to a low price

# CARTER

Vernier Control  
 RHEOSTAT

6 ohms ..... \$1.50  
 20 or 30 ohms \$1.75

Small spiral coil of resistance wire gives **VERNIER CONTROL**

Heavy phosphor-bronze springs

One-hole Mounting

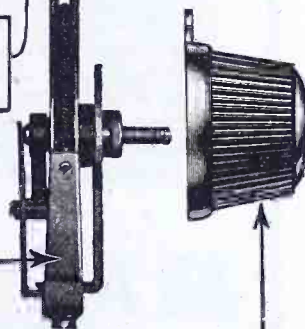

Smooth-running contact; wide surface.

Clock spring pig-tail insures positive connection. No bearing contacts used.

Disc is Finished in a Special Satin Silver.

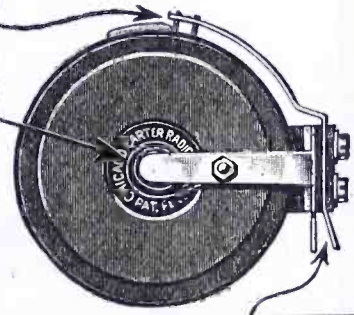

Wide spaced solder terminals

Knob with Pointer adjustable to panels of varying thickness.

Any Dealer can Supply



Write for Catalog

Coast Representative: Atlantic & Pacific Agencies Corp., San Francisco

### JONES "Color Cap" CONNECTORS

Follow the Colors You Can't Go Wrong  
 Radio fans, this is just what you have long been looking for. An insulated plug connector protecting batteries as well as tubes. Remove your old binding posts and put in color caps—7 colors, 25c each.

MANUFACTURED BY  
**HOWARD B. JONES**  
 612 S. Canal Street Chicago, Ill.  
 Western Distributors  
 A. S. LINDSTROM, 111 New Montgomery Ave., S A N FRANCISCO  
 B. W. FRANK, 330 San Fernando Bldg., LOS ANGELES, Cal.



### DO YOU OWN A SET OF

**EBY ENGRAVED Binding Posts**

They excel in quality. You can't lose the parts.



Demand genuine EBYS from your dealer.  
 The H. H. Eby Mfg. Co., Phila., Pa.

Tell them that you saw it in RADIO

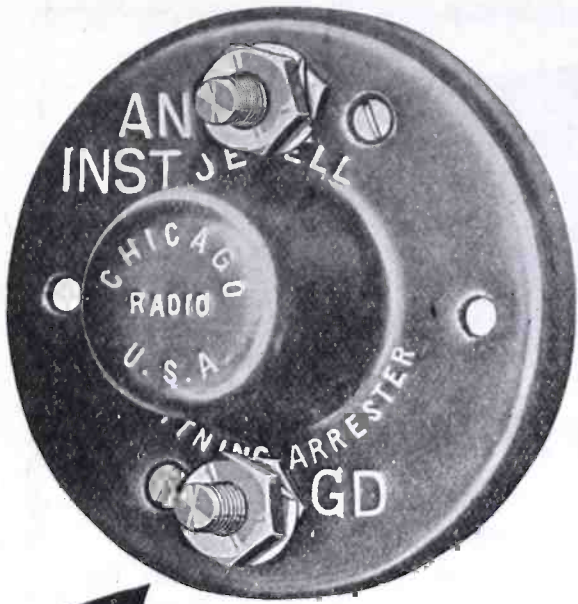

# JEWELL LIGHTNING ARRESTER

Approved by Underwriters

The latest regulations of the National Board of Fire Underwriters call for a lightning arrester on every building having an outside aerial. The Jewell Arrester has passed all the Underwriters' tests and carries their approval.

The case is made of porcelain with a brown finish that harmonizes with interior woodwork. The price is right.

PRICE \$1.10

ORDER FROM DEALER

**JEWELL ELECTRICAL INSTRUMENT CO.**  
1650 Walnut St.  
Chicago



CHARGE YOUR BATTERY FOR A NICKEL

## The Gold Seal Homcharger

Charges Radio and Auto Batteries at home overnight for a nickel. Your dealer has it. Write for FREE booklet and list of broadcasting stations. The Automatic Electrical Devices Co. 117 West Third St., Cincinnati, Ohio

Use — Price 75¢

**DURHAM**

**Variable Grid Leak**

At dealers, or postpaid  
Durham & Co., 1936 Market St., Phila.

The difference between a MAR-CO small part and one that lets energy leak may be just the difference between getting a D.X. station or losing it

Every day, too careful purchasers select MAR-CO STA-PUTs — the famous plugs that do everything you expect, yet cost but 40 cents! Now improved and strengthened, STA-PUT is the outstanding plug value!

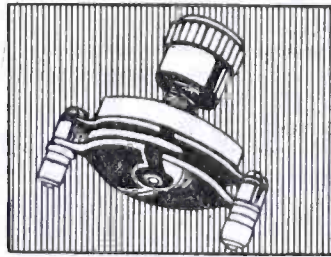

The compact, leak-proof construction, and the amazingly smooth, easy operation, of MAR-CO neutralizing condensers works wonders in all radio frequency circuits. Perfect neutralizing of tube capacity for \$1.25.



\$15.00



**Clear as they are Loud**

with acoustic properties resembling those of a rare old violin.

## MADERA CLEAR SPEAKERS

made from die-cast WOOD, an artificial wood, cast in steel dies under great pressure and heat.

**No More Jangle of Metal Horns**  
But, rather, a pure, full, clear tone that gives radio a new delight.

No. 804, above illustrated, 12 in. high with 10 in. bell, especially suited to summer vacation use. Because compact, sturdy, almost unbreakable Sent postpaid for only \$15.00  
Larger sizes at correspondingly low prices.

When you write for circulars, give name and address of dealer you wish to favor.

**American Art Mache Co.**  
357 W. Austin Ave., Chicago, Illinois

Tell them that you saw it in RADIO

## RECEPTION OF RADIO WAVES

Continued from page 14

tive and the cold plate gives off no electrons itself.

Obviously, if an alternating voltage were applied between plate and hot filament, current would pass during that half of the cycle when the plate were positive but not during the other half cycle. The tube might therefore be used as a detector in place of a crystal and when so used is called a Fleming valve in honor of the man who first suggested its use for this purpose. Fig. 32 shows

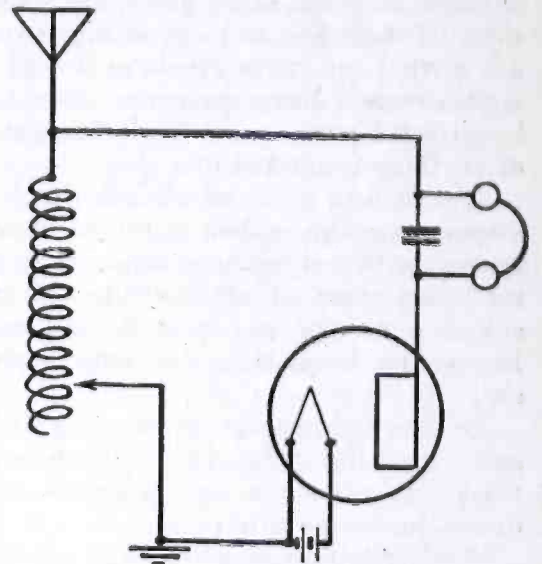

Fig. 32. Circuit with Two-Element Tube as Detector

a receiving circuit using a two element tube as a detector. The theory of rectification is identical with that discussed under crystal detectors.

If a third electrode consisting of a wire grid is placed between the hot filament and cold plate as shown in Fig. 33 it will be found that the current in the plate circuit as measured by the plate milliammeter will depend very materially upon the potential of the grid with respect to the filament. Fig. 33 shows

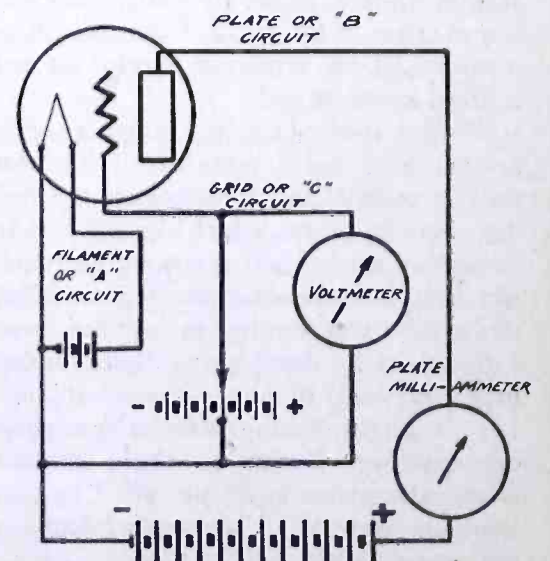

Fig. 33. Circuit for the Study of Three-Electrode Tube

a circuit which may be used to study the effect of the potential of the grid on the plate current of a tube. The filament is heated by a battery of from 2 to 6 volts (depending upon the tube) and kept at



a constant temperature. A battery of from 22 to 110 volts is used to keep the plate positive with respect to the filament. The mid tap of a battery of 10 or 20 volts is connected to the filament as shown.

If the movable tap is shifted to the right the grid will be made positive with respect to the filament. The effect of this is to accelerate the electrons as they leave the filament which increases the current in the plate circuit. Shifting the grid tap to the left makes the grid negative with respect to the filament. This will decrease the plate current as the negative grid tends to drive the electrons back to the filament and prevents their passing to the plate. Curves showing the variation of plate current in a tube circuit as a function of the grid voltage are called the static characteristic curves of the tube. They are very useful in determining how the tube should be used. Fig. 34 shows static characteristic curves of a tube for several plate voltages. Use of these will be made later in discussing the adjustment of tube circuits for various purposes.

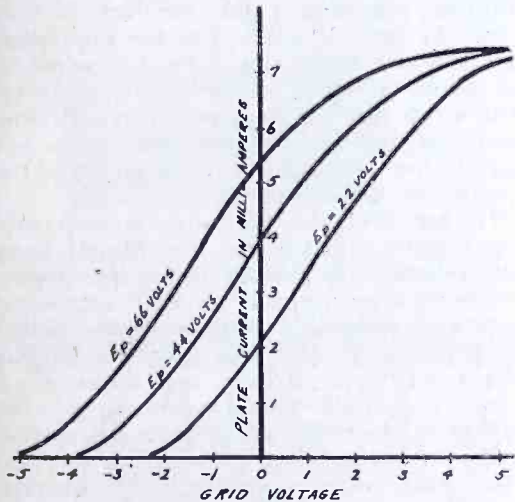

Fig. 34. Static Characteristic Curves of a Three-Element Tube

The circuit which lights the filament is called the filament or *A* circuit. The circuit to the plate is often called the *B* circuit. The circuit connecting the grid to the filament through one or more devices is called the grid or *C* circuit. Batteries in these circuits are called *A*, *B*, and *C* batteries. *A* batteries for receiving tubes may be either storage or dry cells, depending upon the tube. If dry cells are used they are usually of the No. 6 type. *B* batteries are usually blocks of 15 or 30 small dry cells specially prepared for this work. These blocks give 22½ and 45 volts respectively. Small cell storage batteries are also used for this purpose. *C* batteries are invariably of the dry cell type as no current is drawn from them. From 1.5 to 8 volts is usually used.

Three types of filaments are in common use today. Platinum filaments coated with barium, strontium, and calcium oxides are used extensively in tubes manufactured by the Western Electric Company. These filaments have a long

**Thinking Radio?**

Then Get Our Free Bulletin No. 92 It shows recent developments and improvements in parts, and the kind you must use if you want the best in Radio. Send for this book today.

**SENT FREE**

**PREMIER PARTS**

Quality Unsurpassed For Every Known "Hook-Up"—All Good Dealers Sell Them.

**Premier Electric Company**  
3813 Ravenswood Ave. Chicago

**3-360 METER STATIONS**

WGI  
WHN  
WMAX

360 METERS

Price \$5.50  
At All Good Dealers

**Broadcasting at once**  
Tuned in Without Interference with the

**UNCLE SAM MASTER TUNING COIL**

Ask your dealer for free diagram, or just send us self-addressed, stamped envelope for circular and panel layout of this wonderful set.

**UNCLE SAM ELECTRIC CO.**  
Plainfield, New Jersey

**TELOS RADIO**

—that the world may hear the world

Danziger-Jones, Inc. New York

**2650 MILES**

—with ONE TUBE. Broadcasting from Atlantic Coast and Cuba heard in California by users of the CROSS COUNTRY CIRCUIT. This range is due to simplicity of set and operation as only one control is used for tuning. Easily and cheaply built. Dry cell tubes may be used. Complete instructions, with panel layout, assembly views, etc., post-paid for 25c. Or further information for red stamp.

**VESCO RADIO CO., Box R117—Oakland, Calif.**

**U.S. TOOL CONDENSERS**

TRADE MARK

**It's Capacity that Counts**

Good condensers are designed according to microfarads, not number of plates alone. U. S. Tool Condensers are designed for correct capacity.

**100% GUARANTEED**  
END PLATES OF CELORON

**FOR Superheterodyne, Superdyne, Inverse Duplex and Four Circuit Tuner Circuits.**

Condensers of recommended capacity for all known circuits are also carried in stock by leading radio retailers.

Write for Booklet.

**U. S. TOOL CO., Inc.**  
114 Mechanic St. Newark, N. J.

Coast Representatives:  
**THE SPECTOR COMPANY**  
Rialto Bldg. San Francisco, Calif.

Ask Your Dealer For a **MONTROSE VERNIER CONDENSER**

The condenser with genuine bakelite end pieces. Has positive contact between the vernier plate and main shaft. Will get the results where others fail, guaranteed to give entire satisfaction.

**MONTROSE MANUFACTURING COMPANY**  
1333 Fulton St. Brooklyn, N. Y.

**SOLD OUT**

We have no copies of May RADIO available but we can supply reprints of Best's Super-Heterodyne at

**25 Cents Each**

**RADIO :: San Francisco**

**Mail This Coupon To Us!**

Every Issue of "RADIO" for the next six months will contain a valuable constructional article on the new SUPER-HETERODYNE. These articles will cost you hundreds of dollars but you can get the entire series for only one dollar. Write your name and address below, attach \$1.00 to this coupon and mail to us. News-stand copies of "RADIO" will be mighty scarce. Protect yourself against missing a single issue by subscribing today.

Name .....

Address .....

Tell them that you saw it in RADIO

## A Boon to D-X Fans!

# ELECTRASOTE

REG. U.S. PAT OFF

TRADE

MARK

## RADIO PANELS

can be bought at any good Radio  
Dealer's Store

**At 25 to 50% less**  
than any other standard panel

With these panels the surface-leakage and power-loss is reduced to the minimum—hence the volume of your set will be *that much greater*.

A good panel deserves proper handling—therefore, to get the best results, use a *sharp* drill with *slight* pressure.

ELECTRASOTE is one of the "Sote" products of world-wide fame introduced by

THE PANTASOTE CO., INC.

All Standard Sizes

JOBBER AND DEALERS:

Write for our interesting proposition.

M. M. FLERON & SON, Inc.

Exclusive Sales Agents for  
Electrasote Radio Panels

Trenton, New Jersey

## DO YOU LISTEN TO KPO--KLX--KGO KHJ--KFI--KGW?

If so—you need  
"Broadcast Program"  
containing complete detailed  
programs for these stations.

Issued Weekly by the  
Publishers of "RADIO"

Write for Free Sample Copy.

## ENJOY A RADIO SUMMER

RADIO will play a wonderful part in your summer pleasures. At home or vacationing—seashore—north woods or mountain nook, radio will be a friendly, convenient companion.

Broadcasting stations are increasing their sending power. The bugaboo of summer static is no longer feared, and so remarkable has been the improvement and simplification of receiving sets that you will find their cost much lower than you might expect.

Give thought now to summer radio. Replace your worn out batteries with Burgess 'A,' 'B' and 'C's, which are recognized by expert and amateur alike as the best obtainable.

"ASK ANY RADIO ENGINEER"

**BURGESS BATTERY COMPANY**  
Engineers DRY BATTERIES Manufacturers  
Flashlight - Radio - Ignition - Telephone  
General Sales Office: Harris Trust Bldg.,  
Chicago.

Laboratories and Works: Madison, Wisc.  
In Canada: General Offices and Works—  
Niagara Falls, Ont.

## BURGESS RADIO BATTERIES

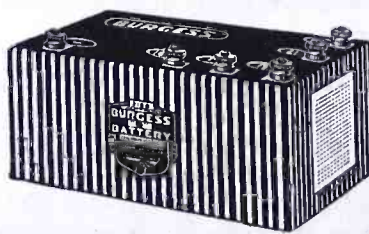

**MIRACO**  
GETS 'EM  
FROM  
COAST TO  
COAST

PRICE ONLY \$29.20

At rock bottom prices you get the efficiency of sets costing three times as much. Users tell us that Miraco Radio frequency receivers pick up stations from coast to coast. Operate either on dry cells or storage battery. Solid mahogany cabinets—finest workmanship throughout. Order direct or send for bulletin.

Two tube outfit . . . . . \$29.50  
Four tube outfit . . . . . \$54.50

DEALERS  
AGENTS—write for proposition quickly—it's a winner.  
THE MIDWEST RADIO COMPANY  
814 Main Street Cincinnati, Ohio

life and give uniform operating characteristics. Oxide coated filament tubes burn at a very dull red. Tungsten filaments are used in tubes made by the General Electric Company. Pure tungsten filaments are burned at almost white heat. Within the past year the General Electric Company has brought out tubes using tungsten filaments which have thorium embedded in the tungsten. The 201-A, 301-A, 199-A, and 299-A tubes are examples. These filaments burn at much lower temperature, require much less power to heat the filament and give excellent operating characteristics.

### AUSTRALIAN NOTES

By L. S. LANE

Radio broadcasting has not progressed with the leaps and bounds predicted for it. This failure to come up to expectations is ascribed to the rather stringent regulations that are in force, which practically mean that there is only one station to listen to, the receiver being sealed in such a manner that only a slight variation is permitted, and if something goes wrong with the transmitting station, whereby the transmitter is sufficiently off its correct wavelength to preclude the receiver from being adjusted accordingly, the program is lost. Then the general public has the impression that they are purchasing a "pig in a poke." As the set is sealed, all one sees is a cabinet with a few dials on the front of it, and some means of inserting a new tube when required, the inevitable result being that the demand for sets is very light.

To get over the difficulty, a conference was recently called by the Post Master General, at which the leading dealers and broadcasters were represented. Several suggestions were put forward, but these finally boiled down into two. One was a scheme similar to that of Great Britain, one broadcasting company controlling and operating all the stations in Australia and collecting a portion of the license fee in payment of their services. The other was a modification, whereby Australia is to be divided into districts, each district to have a strictly limited number of Class 1 stations, these stations being reimbursed on a basis of their operating costs, and also on a vote of the receivers, the revenue coming from the receiving license fees. Then another class of stations were to be permitted. These were allowed to do direct advertising, but were precluded from participating in any distribution of the revenue from receivers. This latter scheme was the one finally recommended for adoption.

The tests with WJAZ, Chicago, were unsatisfactory, static was extremely heavy on the night arranged for, and consequently no definite results were reported. Several experimenters claimed having received music at the time of the test, but these were mostly identified as having originated in Australia. Had the weather conditions been favorable, there is no doubt that success would have resulted from this effort to cross the Pacific and half the United States in one jump.

The new Pacific Coast station, KGO, is received in Australia nearly every time that he works late. When it is considered that Midnight Pacific time is only 6 p.m. East Australian time, one realizes that it is necessary for him to work after midnight to be received after dark in Australia. New Zealand is a different matter, midnight corresponding to 7:30 p. m. New Zealand time. KGO is heard there regularly with sufficient strength to operate a loud speaker, using three and four-tube sets, distance a mere 6000 miles.

Tell them that you saw it in RADIO

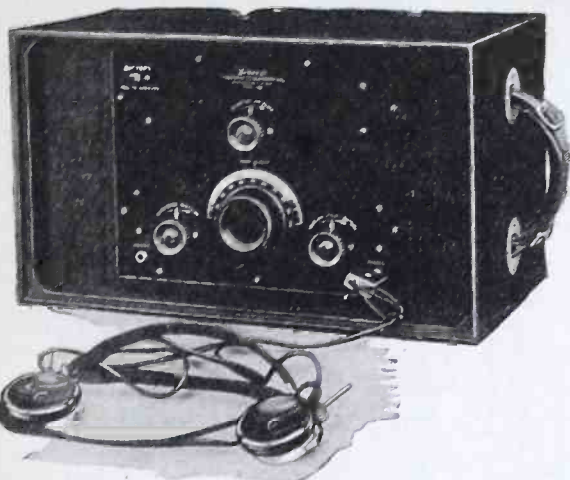

## Federal No. 102 Special Set is "CONVERTIBLE"

"Convertible" is the only word that even nearly describes the Federal No. 102 Special Receiver. It is a complete "portable" set, with dry batteries, head phones, etc., ready for immediate camp or road use—PLUS the capacity for quick and easy changing to wet battery for city or country "home" use. True to Federal standards, the No. 102 Special incorporates exceptional tone beauty, selectivity and distance range. Federal flexibility pervades throughout—the No. 102 Special will operate perfectly on any tube interchangeably.

*Ask any Federal Dealer for a demonstration of the  
Federal No. 102 Special Set*

**FEDERAL TELEPHONE AND TELEGRAPH CO.**  
BUFFALO, N. Y.

Boston, New York, Philadelphia, Chicago, Pittsburgh, San Francisco;  
Bridgeburg, Canada; London, England



Look for this sign



# Federal

Standard **RADIO** Products

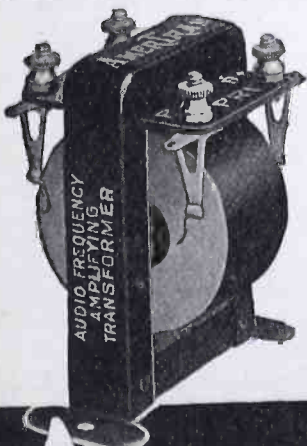
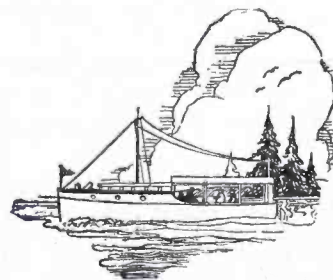

*Improve Your Set  
with an  
AmerTran  
and enjoy radio  
this summer  
as never before*

# AMERTRAN

TRADE MARK REG. U.S. PAT. OFF.

Type AF-6 (Turn ratio 5), has long been acknowledged the Standard of Excellence for audio amplification.

Type AF-7 is now offered for 2nd or 3rd stage amplification in conjunction with AF-6 for 1st stage. In this use AF-7 decreases the tendency to overload the last amplifying tube on loud signals.

Price, either type, \$7.—at your Dealer's

**AMERICAN TRANSFORMER COMPANY**

*Designers and builders of radio transformers for over 23 years*

174 Emmet St., Newark, N. J. Cal. Office, Rialto Bldg., San Francisco

## TRI-JACK

THE most notable improvement ever made in radio jacks. Put **TRI-JACK** on your set and eliminate jack troubles forever.

**TRI-JACK** is dustproof, solderless, and super-compact (solid Bakelite 1" x 1"). It is the nearest to Zero capacity so far. **TRI-JACK** combines the single and the double circuit jack in one. Insist upon **TRI-JACK**. Your set needs them.

Pacific Coast Representative:  
**FREDERIC L. TOMLINSON CO.**  
1113 Wall St., Los Angeles, Calif.  
447 Pacific Bldg., San Francisco  
116 13th St., Seattle, Wash.

\$ 1.25

BROOKLYN METAL STAMPING Corp.  
718 Atlantic Avenue, Brooklyn N.Y.

Tell them that you saw it in RADIO

# "A THING OF BEAUTY" THE "RF22"



A "Five-Tuber" That Acknowledges No Peer

Write us for  
Pamphlet and Testimonials

**HALLOCK & WATSON RADIO SERVICE**

192 Park Street "KGG" Portland, Oregon  
WESTERN DEALERS—MAY WE QUOTE YOU?

## CRYSTAL VS. VACUUM TUBE

*Continued from page 34*

curves of crystals shown in Figs. 3 and 4. They look very much like the vacuum tube, curved at the bottom just like the characteristic of the vacuum tube. In

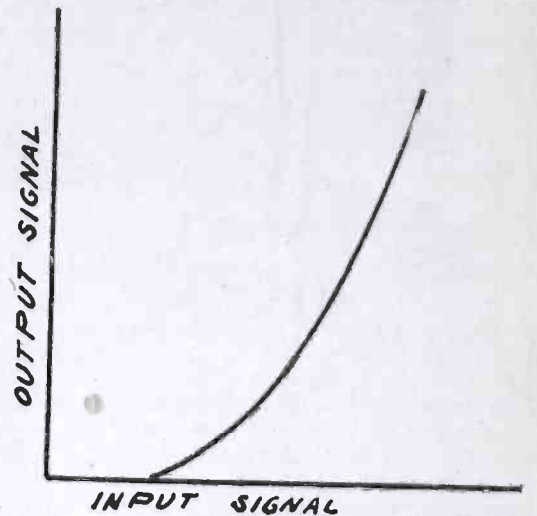

Fig. 3. Carborundum Crystal Detector Characteristics

truth, the crystal follows practically the same law of response as the vacuum tube, it is likewise a "square law" detector, and it introduces the same kind of distortion as the vacuum tube. From the similarity of the curves of these detectors one would expect them to behave the same—and they do. There is no difference in their performance as far as quality of reproduction goes, and there is no logical reason for glorifying the crystal in any way.

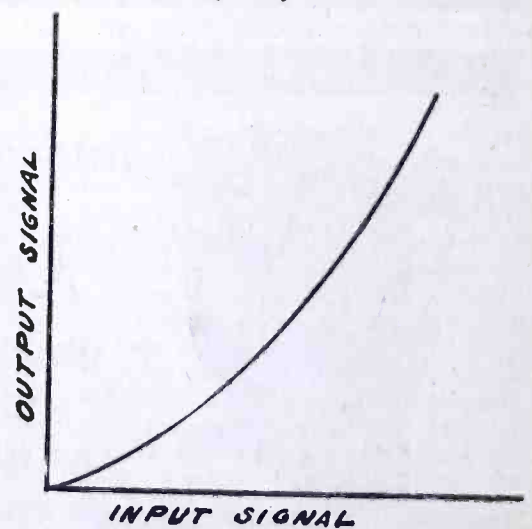

Fig. 4. Perikon Crystal Detector Characteristics

It is of interest to inquire how this myth about the superior quality of the crystal arose. Everybody who has operated a receiving set knows that, when the signal—be it speech or music—sounds bad and raucous, it can be made to sound much better by toning it down, getting a weaker signal. The harmonic distortion introduced by the square law detector is likewise weakened and does not stand out as glaringly. The crystal detector, being considerably less sensitive than the vacuum tube detector, is always in the state where the harmonic distortions are less noticeable, simply because the signal is so much weaker. If the crystal detector were as sensitive and

# RADIO TUBES!

**\$3.25**

**Samson--Apex**

Types C-300, C-301-A, C-299, C-11, C-12,  
UV-200, UV-201-A, UV-199, WD-11, WD-12

Postpaid, Cash or C.O.D., each \$3.25

**We Repair** all Cunningham, Radiotron,  
and other makes bearing  
above type num-  
bers, and give 12-hour service.  
Price, Cash or C. O. D., each **\$2.75**

### GUARANTEE

We guarantee every new tube to be equal to any tube on the market and to give the service you have a right to expect. We guarantee every repaired tube to be as good as new. Return any unsatisfactory new or repaired tube after six days' trial with filament intact, and we will at once replace it, or if desired, your money, including all mailing costs, will be cheerfully refunded.

**BEWARE OF "GYP" TUBES!** We test every tube for vacuum, sensitivity, and stability. We bombard tubes in external high-frequency induction furnaces instead of by tremendously overheating filaments, as is done by many tube makers and repairers. Our tubes are not the cheapest, but they are honest tubes.

**S. P. HANKINS & CO.**

1411 Castro Street

Oakland, California

Tell them that you saw it in RADIO

amplified as much as the vacuum tube detector its distortions would stand out just as much, for they are present to the same extent. There is nothing in the statement that the crystal detector gives better quality than the vacuum tube. It has other virtues, of course, but this one it has not, and this fact should be given as much publicity as the inaccurate and erroneous statement about its exceptional quality of reproduction.

**RECENT RADIO HAPPENINGS**

The proposed 10 per cent tax on radio has been defeated.

The American Tel. & Tel. Co. has offered a license agreement to all broadcast stations whereby a payment of \$4.00 per watt of rated output releases the station from all claims for past patent infringement and allows continued operation for radio telephone broadcasting (including broadcasting for toll or hire). The minimum fee is \$500 and the maximum \$3000.

The Court of Appeals at the District of Columbia has decided that Lee De Forest is entitled to priority as the inventor of the audion as a means of producing sustained electrical oscillations in transmission by radio or otherwise. This reverses the holdings of the Commissioner of Patents, who had awarded the priority to Edwin H. Armstrong. Its effect will be to allow the De Forest Company to manufacture sets employing tubes as oscillators, but not to license others, this licensing right having been transferred to the American Tel. & Tel. Co. It is not expected to affect the Armstrong "regenerative" circuit licenses.

Regular broadcasting in Austria will start July 1 from the War Ministry building at Vienna. Expenses will be covered by the collection of a yearly fee of about 50 gold crowns from each owner of a radio set. There is also a tax of 10 crowns on each set sold.

A personal message from some amateur station in Denmark addressed to L. W. Mammon of Chicago, Ill., was relayed from British 5GV through 1XAH at Cambridge, Mass., to 9BT at Evanston, Ill., who phoned the message to Mr. Mammon on May 11th.

Neither the White nor the Dill bills passed Congress. There has been too much investigation and too little legislation. The only hope left is that they may be passed at the December session.

A committee appointed by the British Post Office has recommended the establishment of a 200-kw. radio telephone station at Rugby, England, the equipment being similar to that used by the American Tel. & Tel. Co. and the Radio Corporation of America in their successful experiments with trans-Atlantic speech transmission.



**Antennae Ammeter**

The Weston Electrical Instrument Company has pioneered the development and manufacture of electrical indicating instruments for 35 years in every branch of the electrical industry. The name Weston on an instrument means that it is the best obtainable. Get one for your set today.

**For Best Results —  
Weston Radio Instruments.**

**W**HETHER in transmitting or receiving —correct voltage or amperage information is of utmost importance to efficient and economical operation.

Control of the filament current or filament voltage makes it possible to prevent premature burn-outs. Facilitates exact tuning. Duplicates results

instantly. The Weston Filament Voltmeter and Filament Ammeter have been designed expressly to meet these requirements. Accurate determination of the plate voltage is also desirable. The Weston Plate Voltmeter is a necessity on every transmitting set and a convenience on all receiving sets.

Booklet J describes and illustrates Weston Instruments. Sent free on request. If your dealer cannot supply you with Weston instruments, we will gladly see that your needs are promptly supplied.

**Weston Electrical Instrument Co., 156 Weston Ave., Newark, N. J.**

Electrical  
Indicating  
Instrument  
Authorities  
Since 1888

**WESTON**

STANDARD - The World Over

**The MASTERPIECE  
of Amplification**

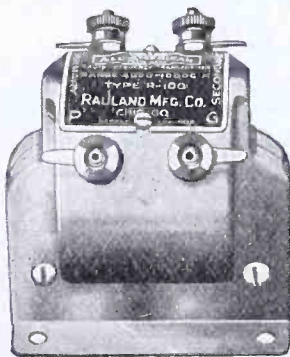

Especially vital to success in Super Heterodyne, Ultradyn and all straight radio frequency and reflex circuits, is distortionless and yet powerful amplification of weak signals. This problem has been incomparably mastered in All-American Long Wave Radio Frequency Transformers, as the most exhaustive and all-inclusive tests have shown. Not only are these latest All-Americans supreme value at six dollars. They are the best long wave transformers that can be purchased at any price!

Watch for the new All-American Low Wave Radio Frequency Transformers.

**ALL-AMERICAN**

**AMPLIFYING TRANSFORMERS**

*Largest Selling Transformers in the World*

RAULAND MFG. CO., 2654 Coyne St., CHICAGO

**BLACKBURN  
GROUND CLAMP**

FOR RADIO CIRCUITS

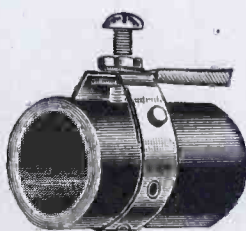

**TYPE No. A-1 CLAMP**  
Adjustable to any size of pipe. Can be attached in one minute. No pipe cleaning necessary. Screw bores through rust and scale. No detachable parts to lose. Assembled with shoe for lead pipe. Not the cheapest but worth more to 10 million users. Heavier types made for lighting circuits.

Samples and prices to dealers.

**Blackburn Specialty Co.**  
1966 EAST 66th ST. CLEVELAND OHIO

**SUPERDYNE**

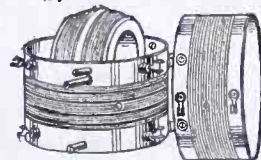

**ORIGINAL GLOBE COILS**  
(Single Mounting)

Wound with silk wire on bakelite to correct specifications. C. O. D. Parcel Post. **\$6.25**

Complete 4-Tube Set, K. D. Panels Drilled, Fitted. **\$35.00**

**GLOBE RADIO EQUIPMENT**  
217 W. 125TH ST. NEW YORK CITY

Tell them that you saw it in RADIO

*New!*

**FIL-KO-STAT**  
SCIENTIFICALLY CORRECT RADIO RHEOSTAT

*with Battery Switch Attached*

**\$2.00**  
AT YOUR DEALER

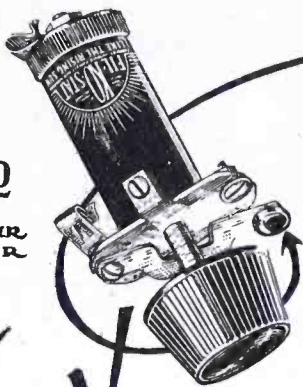

at no extra cost. Still \$2.00. Still the filament control of proven supremacy. The only rheostat and battery switch in one. If you want perfect control of any type tube in any hook-up—if you want DX stations you never heard before—if you want silent tube operation—maximum signal regeneration—longer tube and battery life—then you must use FIL-KO-STAT, the Filament Control of Infinite Adjustment. The Battery switch (patent applied for) attaches to regular mounting screws. No extra holes to drill.

Write for a free copy of our new booklet  
"Improved Reception Through Scientific Tube Tuning"

*New!*

**FIL-KO-SWITCH**  
SCIENTIFICALLY CORRECT  
*Simple-Sturdy-Sure*

**50¢**  
AT YOUR DEALER



A necessity on any radio set. "Current on or off at the touch of your finger." It takes minimum space both on the panel and behind it. The single-hole mounting makes it easy to attach. Fitted with double connections—connect wires to the terminal screws or to the solder lugs. Sturdy interior members give positive contact. Metal parts heavily nicked.

*New!*

**FIL-KO-LIGHTNING**  
SCIENTIFICALLY CORRECT  
*Prevents Leakage Losses*

**\$1.50**  
AT YOUR DEALER



This arrester with its bell-shaped shield will positively keep dry and not gather dust or other conductive matter which causes short-circuits from aerial to ground. This makes certain that all radio impulses reaching the aerial pass through your set, insuring maximum reception. Insulation is of polished Bakelite—the best, most moisture-proof dielectric. It is hermetically sealed—no dirt or moisture can reach the gap. Rugged mounting bracket keeps FIL-KO-Lightning Arrester rigid under all conditions.

MADE AND GUARANTEED BY



HARRISBURG — PENNSYLVANIA  
Dept. R 724

Foreign Representatives

**RADIO STORES CORP.**

New York City

New York Office  
**220 WEST 34TH STREET**  
(Address All Mail to the Factory)

**NEW ZEALAND CALL LETTERS**

- 1YA Auckland Radio Service, Ltd., Auckland, 500 watts 260 meters.
- 2YK Dominion Radio Co., Ltd., Wellington, 500 watts 275 meters.
- 4YO Radio Supply Co. (Norman Arundel), Dunedin, 500 watts 370 meters.

*Private Broadcasting Stations*

- 4YA British Electrical and Engineering Co., (F. J. O'Neill), Dunedin, 500 watts 370 meters.
- 2YM Gisborne Radio Co., Gisborne, 500 watts 335 meters.
- 1YB Pearson, Charles Henry (on behalf of Newcombe, Ltd.), Auckland, 500 watts 260 meters.
- 2YB Wellington Broadcasters, Ltd., Wellington, 500 watts 275 meters.

*Experimental Stations*

- 4XO Prof. Robert Jack (for University of Otago), 50 watts 395 meters.
- 2XB Victoria University College, Wellington, 50 watts 395 meters.

*Transmitting and Receiving Stations, Grade I*

- 4AA Bell, Frank Dillon, Waihemo, 50 watts 171, 161, 151 meters.
- 2AA Bingham, John Merton, Levin, 50 watts 180, 170, 160 meters.
- 2AM Buist, Dr. William Frederick, Hawera, 50 watts 180, 170, 160 meters.
- 3AC Radio Society of Christchurch (Inc.), Christchurch 15 watts 300, 175, 155 meters.
- 2AQ Coutts, William Morton, Taihape 15 watts 175, 165, 155 meters.
- 1AA Edwards, Cecil Norman, Auckland, 10 watts 180, 170, 160 meters.
- 1AM Hamilton Amateur Radio Club, Hamilton, 50 watts 175, 165, 155 meters.
- 1AH Hartle and Gray, Auckland, 50 watts 175, 165, 155 meters.
- 4AD Jordan, Arthur Edward, Invercargill, 50 watts 175, 165, 155 meters.
- 2AC O'Meara, Ivan Henry, Gisborne, 50 watts 175, 165, 155 meters.
- 3AA Orbell, Reginald John, Christchurch, 50 watts 175, 165, 155 meters.
- 4AB Otago Radio Assn. (Inc.), Dunedin (Transmitting apparatus dismantled 17-8-'23), 50 watts 300 and 160 meters.
- 4AC Robinson, Robert Edward, Dunedin, 50 watts 175, 165, 155 meters.
- 2AS Simpson, Albert Edward Huia, Wellington, 15 watts 160, 170 meters.
- 2AF Sinclair, William John, Gisborne, 50 watts 176, 165, 150 meters.
- 3AB Vincent, Francis, Christchurch, 20 watts 175 and 155 meters.
- 2AH Wanganui Amateur Wireless Club, Wanganui, 50 watts 175, 165, 155 meters.

"The Best Built Set in America"

A Fact—Not a Slogan  
R-212  
MATCHED DIAL



Licensed by  
Independent Radio Manufacturers, Inc.  
**NEUTRODYNE**  
Pat. March 27, 1923 and April 1, 1924.  
Hazeltine Pats. Nos. 1,450,080 and 1,489,228  
Other Patents Pending.

ARTISTRY—QUALITY—  
WORKMANSHIP and  
ENGINEERING are exemplified

in the R-212 Matched Dial NEUTRODYNE 5 TUBE MODEL

**RADIO SERVICE LABORATORIES**

1007-11th Ave.

Asbury Park, N. J.

**RADIO Wants You!**  
*Earn \$100 a Week*

Radio, the wonderful new growing profession, offers you a glorious opportunity—big money, fascinating work, easy hours, a real future! Wonderful new course prepares you quickly in spare time at home. Famous radio experts help to give you practical work. Instruments supplied free. Write for Free Book, "Rich Rewards in Radio."

National Radio Institute, Dept. 10GA Washington, D.C.

"Built First - Coto - to Last"

**INSIST ON THE SILVER PLATED AIR CONDENSER FOR YOUR RADIO SET.**

**CONSTANT WAVE AIRCRAFT TRANSMITTER AND RECEIVER**

By S. R. WINTERS

ENCLOSED in a water-tight jacket, a transmitter designed and built at the Bellevue Experimental and Research Laboratory of the United States Navy Department is a claimant to novelty in several particulars. Significant among

transmitter emits a wave of marked constancy even though 30 or 40 ft. is subtracted from the 150 ft. of trailing-wire antenna. Furthermore, the banking of an aeroplane, or other movements in flight with respect to the body of the air-going machine, does not exercise any appreciable influence on this system.

Enough air gains admission to permit of the proper functioning of the radio instruments.



New Constant Wave Aircraft Transmitter and Receiver

these departures is its capacity to emit a constant wave despite the varying conditions to which it may be subjected on aeroplanes. For this reason it is aptly designated as an aircraft constant-wave transmitter.

The use of continuous-wave transmitters on aircraft, heretofore, has been characterized by indifferent, if not altogether unsatisfactory, results. This has been particularly true when flying in bumpy weather or during other conditions which vary the capacity of the antenna system. The newly designed

The transmitter employs four 7½-watt vacuum tubes. The receiving unit includes three type N tubes, a detector and two stages of audio-frequency. Power is driven from a fan-driven generator.

The complete equipment weighs about 80 pounds. The apparatus was developed under the direction of Dr. A. H. Taylor, head of the naval radio laboratory at Bellevue.

Preliminary tests under flight conditions have indicated that it has a transmitting range of at least 100 miles.

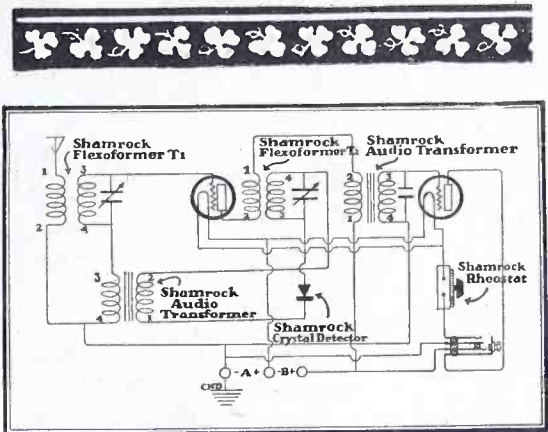

**Radio Marvel of 1924**  
the  
**Shamrock-Harkness**  
**Two-tube Reflex**

THE Shamrock-Harkness Reflex is stampeding the radio world. It's a whiz for performance. By an astonishing feat of engineering craft this two-tube set has the pulling power of a standard four or five-tube receiver. Operates a loud speaker with wonderful clarity and volume. Does not whistle, squeal nor radiate. It's remarkably selective and easy to operate. Many Shamrock fans report that they receive 1500 to 2000 miles consistently with this set.

**Shamrock-Harkness Kit**  
contains all parts to  
build the Harkness  
Reflex

SHAMROCK is a licensed manufacturer of parts to build this set. We have spent months designing the various parts necessary to construct it. All parts are included in the Shamrock Kit. Flexoformers, Rheostat, Crystal Detector, Audio Frequency Transformers, etc.—are Shamrock made and Shamrock guaranteed. Buy only genuine parts—avoid imitations. Only when you buy the genuine Shamrock parts will you be sure of getting maximum results with this set.

**KIT COMPLETE, \$35**

Send for booklet

THE "Shamrock Radio Builder's Guide Book"—contains diagrams and complete instructions for building the Shamrock-Harkness Reflex—and nine other receivers at prices from \$15 to \$50. Send 10 cents for this important booklet today. Shows you how to select the best set for your requirements, and how to construct it at the least cost.

SHAMROCK MANUFACTURING CO.,  
Dept. 72, Market St., Newark, N. J.



SHAMROCK MANUFACTURING CO.,  
Dept. 72, Market St., Newark, N. J.

I enclose 10 cents (U. S. Stamps or coin) for copy of "Shamrock Radio Builder's Guide Book, containing Log Record." Also diagrams and complete instructions for building 10 sets at prices ranging from \$15 to \$50.

Name.....  
Address.....  
Dealer's Name.....



Tell them that you saw it in RADIO

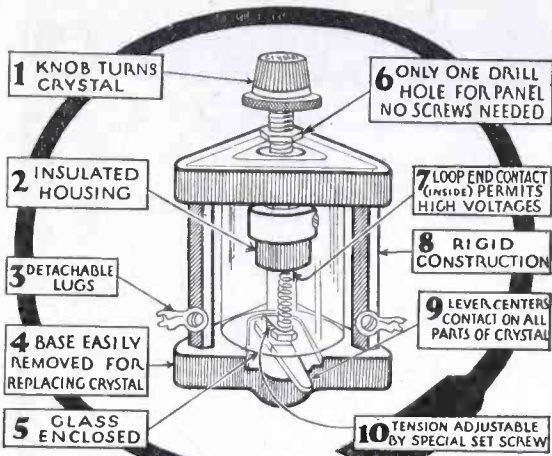

# Best Crystal Ever Designed!

FRESHMAN DOUBLE ADJUSTABLE CRYSTAL DETECTOR, for base or panel **\$1.50**

Super-Cryst. I with Non-Metallic Housing, 50c  
At your dealer's or send purchase price and you will be supplied postpaid.

FREE! Write for building plans and hook-ups of Super-Heterodyne, Reflex, and other popular circuits. Ask for list L-102.

**Chas. Freshman Co. Inc.**  
Radio Condenser Products  
106 Seventh Ave., New York

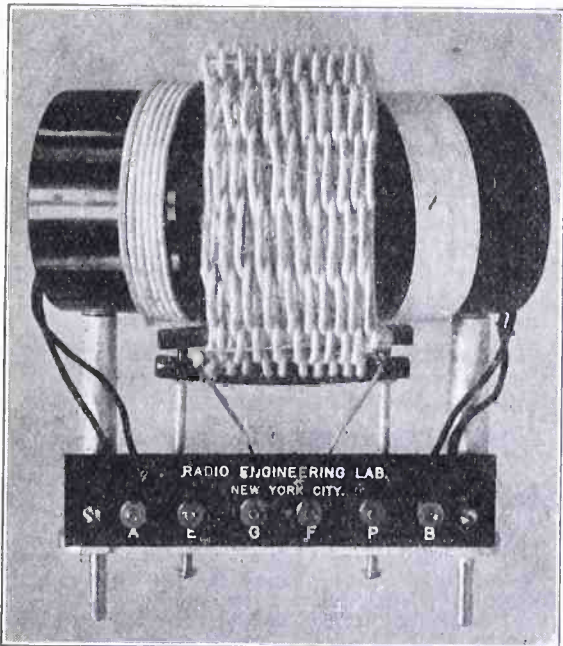

## LOW LOSS TUNER UNIT

Most Efficient Tuner Available  
Real DX. Reception Extremely Sharp Tuning

TWO TYPES: AMATEUR—90 to 275 METERS  
BROADCAST—250 to 550 METERS  
Price \$10 each Write for Information

**A. C. LOPEZ & CO.**  
Sole Distributors

334 FIFTH AVENUE NEW YORK CITY

## To Manufacturers of Radio Receivers

- We will make horns or concealed loud speakers and sounding boxes to order, using Madera die-cast wood in any size, shape, or quantity.
- Or, we will supply our regular Madera "Clear-Speakers," in quantities, to be offered by you as standard equipment. This will insure the 100% performance of your sets and protect you from being blamed for the "frightfulness" of metal loud speakers.

AMERICAN ART MACHE COMPANY  
357 West Austin Avenue Chicago, Illinois

**RADIO K. B. PARTS**

Formerly  
"MASTER" Line

**REDESIGNED AND IMPROVED**

For ACCURACY, EFFICIENCY and APPEARANCE, insist on "K.B." products from your dealer. Ask to see our new type variable condensers. Special New Features.

Jobbers and Dealers write for attractive prices and discounts.

**K. B. MANUFACTURING CO.**  
Dept. C—No. 222 Eighth St.,  
San Francisco

*BAKELITE Mouldings, Dies, Custom Work*

**50¢** **50¢**

*Genuine*  
**Miller-B-Metal**  
Crystal

Reg. U. S. Pat. Office

Once you use Miller-B-Metal Crystal you'll have no other—it certainly makes your set "talk up." Two extra pieces of Miller-B-Metal sent free with every crystal container. Order from your dealer or direct from factory **PACIFIC COAST DISTRIBUTOR** Somewhere in San Francisco or Los Angeles there is a man or organization who can represent us on the coast. If seriously interested write immediately.

**THE A. H. MILLER RADIO COMPANY**  
1218 20th Street Detroit, Mich.  
The formula for B-Metal was originated by A. H. Miller

**ALIVE-LOUD**

*from the R-B laboratory*

This 52 page Book describes how to make **9 KNOCKOUT Radio Receivers**

**50¢**

B. R. Linton, Hapeville, Ga., using the 1-tube Knock-out set described in this book, hears KFI, Los Angeles and many other distant stations regularly on his loud speaker.

YOU, too, can build a Knock-out distance-getter. This book tells you how! No "trick" circuits; each of the sets has been built and tested in the Radio Broadcast laboratory—where all new circuits are tried out—under the personal direction of Arthur H. Lynch. The 9 Knock-out sets described in this book were chosen because of the exceptional results obtained with them by hundreds of Radio Broadcast readers. You can buy all of the parts from your nearest dealer.

The first edition of Radio Broadcast's Knock-out series was sold in less than 10 days. The second edition—more data, more photographs—is going fast. If your dealer cannot supply you, use the coupon today. If dissatisfied we will refund your money.

**RADIO BROADCAST, Doubleday, Page & Co.,**  
Garden City, N.Y.

I enclose 50 cents in payment for a copy of Radio Broadcast's Knock-Out Series to be sent to

R

Tell them that you saw it in RADIO

## A SELECTIVE AND EFFICIENT TUNER

By H. T. GALLAHER

The tuner designed by 6ZJ and described in March, 1923, RADIO is the starting point of the tuner herein described. You may remember an article in December, 1923, RADIO describing some improvement to this tuner. The author has gone further and made a three-circuit tuner out of this hook-up, and, contrary to general assumption, instead of taking more parts it takes less.

The circuit also becomes more selective, less noisy, smoother in operation and easier to handle both as to tuning and as to regeneration control. The switch lever, points and tapped coil are done away with. The entire list of broadcasting stations comes in on one full swing of the condenser dial, thus eliminating the annoyance of changing the switch lever. It also makes calibration easier as the length of the aerial affects condenser setting very slightly. With a tapped coil a station will be tuned in on a certain switch point and condenser setting. On another switch point, it will be tuned in on another condenser setting, thus making calibration cumbersome. Tuning with the condenser only will be readily appreciated by all fans using tapped coil circuits of this nature.

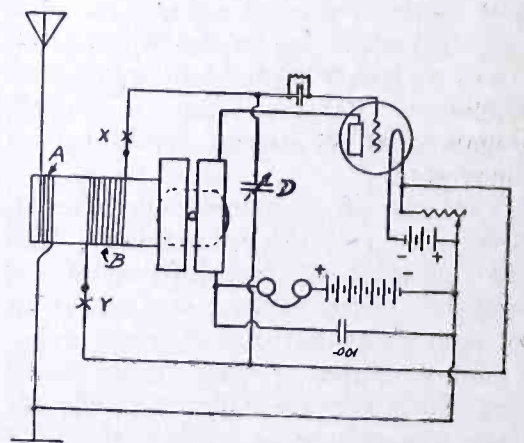

Hook-up for Efficient and Selective Tuner

Now as to the hook-up. Advantage is taken of the untuned primary system coupled to a tuned grid circuit. A variometer in the plate circuit controls regeneration. First secure a piece of tubing 3 in. long and with its outside diameter about the diameter of the rotor ball. On one end of this wind coil A—which for a 3-in. diameter tube should be 8 turns and for a 4-in. tube 6 or 7 turns of No. 22 double silk-covered wire. Start coil B 3/4 in. away. For a 3-in. tube B should be 45 turns and for a 4-in. tube 37 or 38 turns of No. 28 DSC wire. C is a standard plate variometer and D a 23-plate vernier condenser. If the set does not oscillate suitably, reverse connections X and Y of coil B. Potentiometers may be included in both the grid return and



the negative *B* battery circuits with added fineness of control.

This circuit will be found considerably more selective than the single circuit type, really easier to handle, and will bring in stations from as great a distance and as quiet and smooth in operation. Another small feature is that your aerial is always grounded (through a small inductance, however), which in a measure helps out on the lightning protection.

**CALLS HEARD**

*Continued from page 49*

By 7SY and 7PD, 345 Mill St., Eugene, Ore.

1ol, 1abs, 1xah, 2bg, 2cg, 2rk, 2cla, 3mb, 3zl, 3bva, 4dy, 4gu, 4hs, 4io, 4pb, 4rr, 4xc, 5az, 5bo, 5ce, 5cv, 5ez, 5ft, 5fx, 5gj, 5ht, (5in), 5jw, 5lg, 5lr, 5mi, 5na, 5pv, 5ql, 5qx, 5qy, 5rg, 5rv, 5tj, 5ts, 5vo, (5xd), 5xah, 5ya, (5za), 5zb, 5aaw, 5ahd, 5air, 5ajb, 5akf, 5akn, 5alj, 5amb, 6bui, 7mn, 8fm, 8hv, 8nd, 8pl, 8qk, 8vq, 8vy, 8acy, 8aih, 8apt, 8atc, 8bfm, 8bjy, 8bmb, 8bnh, 8bxx, 8cgl, 8cgu, 8cmv, 8cpl, 8cud, 8dat, 8dts, 8xbh, 9an, 9bx, 9dp, 9ee, 9em, 9er, 9iq, 9lz, 9mc, 9ss, 9st, 9tm, 9xg, 9zt, 9aar, 9aa, 9acq, 9acx, 9aec, 9aen, 9aep, 9agl, 9agy, 9ahv, 9ahz, 9aai, 9aim, 9aks, 9aku, 9amb, 9amp, 9ape, 9apf, 9aqc, 9ase, 9atn, 9avg, 9avm, 9avn, 9awp, 9avw, 9axx, (9azg), 9bak, 9bal, 9beh, 9bdq, 9bex, 9bez, 9bhi, 9bio, (9bji), 9bjk, 9bjn, 9bli, 9bof, 9bpu, 9bqq, 9bri, 9brk, 9bto, 9buh, 9bxq, 9bze, 9caa, 9ccs, (9cde), 9cdv, 9ceh, 9cek, 9efi, 9ega, 9ehc, 9eip, 9cjt, 9cka, 9ckd, 9eld, 9cmk, 9cnv, 9cqv, 9cwj, 9daw, 9day, 9dbf, 9dcp, 9det, 9dej, 9dkb, 9dkx, 9dpp, 9dpx, 9dqu, 9dro, 9drw, (9dsw), 9dte, 9dtk, 9dun, 9dvn, 9dwn, 9dxy, 9dyi, 9dyr, (9eak), (9eam), 9ebb, 9edb, 9eea, 9egu, 9egw, 9eht, 9eky, 9xax, 9yam.

Sixes and sevens wk'd: 6dd, 6fy, 6gq, 6gr, 6kb, 6kn, 6la, 6mp, 6nx, 6qh, 6qk, 6rw, 6sa, 6vc, 6vd, 6zh, 6zx, 6aan, 6aao, 6aig, 6aft, 6agk, 6ajh, 6aju, 6anq, 6aoh, 6aqd, 6aro, 6aur, 6avr, 6avv, 6awe, 6bel, 6bez, 6bhw, 6bih, 6biw, 6bjq, 6bji, 6blm, 6bmn, 6bnc, 6bnu, 6bny, 6bql, 6bra, 6buf, 6bed, 6ebf, 6ebw, 6ect, 6ecy, 6egd, 6ego, 6ehe, 6eik, 6eij, 6eiv, 6ekf, 6elv, 6cmd, 6emi, 6eng, 6zo, 7ak, 7af, 7av, 7ax, 7bd, 7be, 7ca, 7cr, 7cw, 7di, 7dm, 7dn, 7dr, 7du, 7dz, 7ed, 7em, 7en, 7ey, 7fa, 7fq, 7fs, 7fy, 7gr, 7gu, 7gv, 7hg, 7ho, 7hq, 7ij, 7io, 7it, 7jh, 7jn, 7kv, 7lh, 7ly, 7mi, 7mp, 7ne, 7nf, 7ng, 7no, 7oh, 7ok, 7ot, 7oq, 7oy, 7pl, 7pz, 7qd, 7qt, 7qu, 7rc, 7rt, 7ry, 7sh, 7td, 7tq, 7wa, 7we, 7ws, 7wu, 7xc, 7yl, 7ze, 7aao, 7aby, 7ade, 7adp, 7adf, 7adr, 7ael, 7afn, 7afo, 7aft, 7age, 7agz, 7aha, 7ahz, 7aib, 7aim, 7aiv, 7aix, 7ajd, 7aja, 7ajv, 7ajy, 7akh, 7aky, 7ald, 7ali, 7ann, 7xac, 7xaf. Cards on my C.W. appreciated. All cards answered.

By 5ANF, 202 Cloworth Bldg., Enid, Okla.

1alj, 1are, 1bie, 1biz, 2iu, 3bpb, 3nr, 4amu, 4cb, 4dc, 4jr, 4my, 4pb, 4pk, 4tn, 5aam, 5abn, 5ail, 5amh, 5cg, 5cn, (5uk), 5xbh, 5za, 6aao, 6aur, (6avr), 6bau, (6bur), 6chv, 6eb, 6zh, 7co, 7cq, 7zu, (8adg), 8anb, 8atc, 8aut, (8bee), 8bch, 8cab, 8cci, 8cwk, 8dgi, 8dhs, 8do, 8er, (8fu), 8jt, 8yx, 8zc, (8zk), 9abk, 9aby, 9adu, 9aep, 9agl, 9ahj, 9ajg, 9ak, 9ami, 9amp, 9amz, 9aqd, 9ayx, 9azr, 9bdq, 9bfa, 9bib, 9bmd, 9bmu, 9bmx, 9bof, 9bqv, 9bqy, 9br, 9brb, 9bri, 9bwu, 9bxv, 9bxw, 9caj, (9ceb), 9ced, 9ce, 9cen, 9efx, 9egq, 9eir, 9eju, 9elx, 9daj, 9day, 9dbq, 9dep, 9der, 9dkq, 9dmw, 9dp, 9dro, 9dsw, 9dwn, 9dww, (9ebt), 9ef, 9efz, 9egt, 9eia, 9ejn, 9ejy, 9eli, 9elq, 9elv, (9le), 9no, 9pe, 9rc, 9rf, (9rx), 9tv.

Can.—4er. Wrked cyl (cy-one) qsa 3/1/24 at 3:45 a.m. C.S.T., qra? Pse qsl. Any rpts on my sigs wud be greatly appreciated; all crds gl'dly ansd.

By 4PV, Davidson College, Davidson, N. C.

1amf, 1boa, 1kr, 2bgi, 2cmg, 2kx, 2lo, 3adv, 3be, 3buy, 3bwt, 3bcm, 3ccu, 3gb, 3gc, 3hs, 3lg, 4eq, 4ft, 4ik, 4io, 4jr, 4oa, 4og, 4qw, 4tj, 5amf (fone), 5amh, 5alj, 5eh, 5ek, 5es, 5gj, 5ka, 5lr, 5mb, 5mo, 5rg, 5ua, 5ue, 5uk, 5xbh, 5abx, 5avx, 5axf, 5bdv, 5bgw, 5bmb, 5boe, 5bvd, 5bzt, 5cep, 5ejp, 5daj, 5dgr, 5dhs, 5es, 5ij, 5lw, 5ry, 5ve, 5xbx, 5xe, 5yd, 9aau, 9aaw, 9afy, 9ahe, 9aim, 9amz, 9atl, 9auy, 9baz, 9bfg, 9bhy, 9bk, 9bna, 9bri, 9brk, 9btk, 9buk, 9bye, 9cfi, 9cfk, 9cmc, 9cmd, 9cow, 9cvi, 9cyv, 9day, 9dbf, 9djb, 9dkk, 9dnp, 9edo, 9eha, 9ekc, 9eky, 9er, 9es, 9fb, 9lt, 9mc, 9nu, 9pb, 9tv, 9wu. Hrd May 10, 11 and 12, on detector only. Those wishing a qsl on their sigs write to 4PV, 148 Avant St., Spartanburg, S. C. 4PV wl be on the air agn after June 1st. All repts appreciated es qsl'd.



a  
**Scotch-  
man**



Plain types: 3-plate \$1.25, 5-plate \$1.50, 13-plate \$2, 17-plate \$2.50, 23-plate \$2.75, 43-pl. \$3, at dealers'.

Vernier type: 13-plate \$4, 23-plate \$4.50, 43-plate \$5.50, at dealers'.

**has nothing on these condensers**

If a Walnut Condenser ever let go of more than .00000? it'd probably buckle up with shame. In which event we'd replace it free. Like the Scotch, these condensers are record-holders for "low losses." And, in addition, they STAY TIGHT for life.

**WALNART  
VARIABLE CONDENSERS**

are the last place to look for trouble. Plates accurately pressed, aligned and locked to stay in strong slotted studs. Bakelite end plates. Ask your dealer first, please.

"Makers of good goods only"

**WALNART ELECTRIC MFG. CO**

Dept. 210

Chicago



See our Booth at the  
**PACIFIC RADIO  
EXPOSITION**  
August 16 to 21

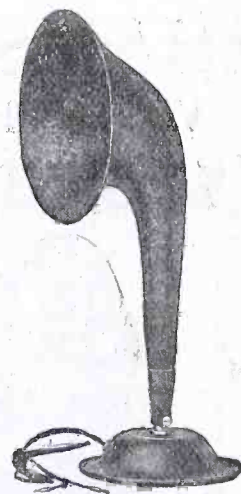

**BRISTOL SINGLE  
STAGE POWER  
AMPLIFIER**

gives additional VOLUME with any two stage amplifier. No separate batteries required. It provides the additional volume necessary to bring in very distant stations on the loud speaker.

**AUDIOPHONE**

Loud Speaker

Quality of reproduction such as only the original itself can equal. Speech that is so distinct that the voice heard is the actual voice of the speaker. Music that requires no tolerant imagination to be recognized as music of the finest type.

The Audiophone furnished in three models — Baby \$12.50, Junior \$22.50, and Senior \$30.00.

Write for Bulletins Nos. 3014 and 3015-R.

**THE BRISTOL COMPANY**  
WATERBURY, CONN.

Pacific Coast Branch Office—Rialto Bldg., San Francisco

**RADIO TUBE  
EXCHANGE**

We Repair All Standard Makes of Tubes  
Including

W.D.-11 or 12  
U.V.-199 or C-299  
C.-11 or 12  
U.V.-201A or C301-A  
D.V.-1 or D.V.-2  
U.V.-200 or 201  
C.-300 or 301

**\$2.50**



**RADIO TUBE EXCHANGE**  
200 1/2 BROADWAY NEW YORK CITY, N. Y.

All Mail Orders Given Prompt Attention  
Orders sent Parcel Post C. O. D.



Registered U. S. Patent Office.

**The Certified Transformer**

Distance **FORD MICA COMPANY, Inc.** Clarity

33 East 8th St.

New York

Tell them that you saw it in RADIO

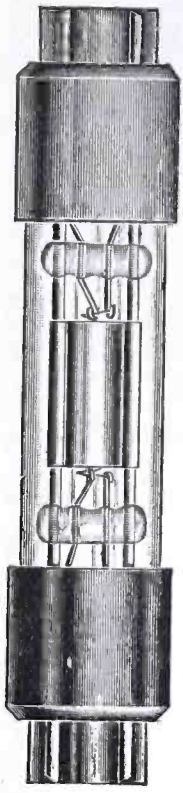

Actual Size

# Around the World!

A New Zealand amateur got Alabama (10,000 miles) on one Myers Tube—heard the signals and message perfectly. Certified by Radio News. This remarkable performance indicates that there is no limit to long-distance reception with Myers Tubes because their design is right.

## Myers Tubes

Practically Unbreakable, add to the efficiency of any set by cutting out noise, tube hiss and interference. Two types: Dry Battery and Universal (for storage battery). Write for free circuit diagrams. Insist on the New Improved Myers Tubes—at reliable dealers—otherwise send purchase price and be supplied postpaid.

**\$5** Each, complete with clips ready to mount on your set; no sockets or other equipment necessary.

**E. B. Myers Co. Ltd.**  
*Radio Vacuum Tubes*  
240 Craig St. W.,  
Montreal, Canada

By 6CEU, Hilo, Hawaii  
1axn, 1cac, 1kc, 1bie, 1aki, 1yk, 1asr, 1xz, 1ary, 1yb, 2azy, 2ana, 2bqh, 2crp, 2awl, 2wr, 2wb, 2le, 2cee, 2xna, 3aao, 3hh, 3ckg, 3bj, 3be, 3lg, 3sh, 3fk, 3blu, 3buy, 3oe, 4io, 4iu, 4gu, 4pk, 4og, 4je, 4rr, 4ob, 4ad, 4gx, 4ai, 4dp, 4su, 4jr, 4ft, 4pv, 4fs, 4xc, 4ll, 4ic, 5ek, 5sd, 5zav, 5ado, (5aic), 5rg, 5jl, 5jg, 5kp, 5zas, 5pp, 5na, 5be, 5ah, 5sd, 5amu, 5cv, 5aja, 5eh, 5aji, 5alm, 5bo, 5aht, 5agh, 5mi, 5uo, 5ot, 5rw, 5rg, 5ajt, 5ft, 5xa, 5qd, 5aas, 5th, 5lr, 5rv, 5aaq, 5aiu, 5alv, 5xac, 5bx, 5dw, 5ql, 5vf, 6ebd, 6brf, 6buy, (6bif), (6arf), 6biw, 6cie, 6aja, (6age), (6afa), (6do), 6zau, 6zt, 6crw, 6avv, 6alo, 6bqs, 6aaq, 6li, 6cfz, 6bsg, (6tn), 6chj, 6cmr, 6aw, 6nk, (6cdb), 6ts, 6nx, 6xn, 6aji, 6che, (6zbu), 6buw (all sixes were hrd in daylight.), 7gs, 7lh, 7io, 7wp, 7co, (7tt), 7by, 7ly, (7agz), 7to, (7fq), 7ali, 7em, 7ju, 7ahv, 7go, 7rk, 8bep, 8asv, 8vy, 8aih, 8cgu, 8epx, 8amm, 8ue, 8apt, 8aig, 8fc, 8er, 8czy, 8acy, 8akd, 8avt, 8wx, 8atc, 8awp, 8ads, 8cud, 8bzd, 8zw, 8bsy, 8yn, 8dgp, 8bkn, 8jy, 8agp, 8dkb, 8com, 8alm, 8fc, 8ago, 8al, 8dae, 8cqx, 8bcz, 8cmv, 8vy, 8rn, 8aaf, 8tr, 8es, 8dki, 8daa, 8dda, 8ic, 8xbo, 8cgy, 8wa, 8uk, 8dhs, 8bed, 8boe, 8bec, 8fm, 8abx, 9aau, 9cgu, 9ell, 9bly, 9elb, (9vm), (9aep), 9ahz, 9ccz, 9am, 9ss, 9bez, 9ehj, 9bze, 9ebt, 9dyr, 9cev, 9bpv, 9dlm, 9bgh, 9aaw, 9daw, 9cvt, 9czo, 9eky, 9ehw, 9dkq, 9qr, 9dli, 9dxu, 9ahh, 9fm, 9ees, 9apf, 9ehj, 9rc, 9ctg, 9baz, 9czm, 9dxn, 9dro, 9aow, 9cks, 9awv, 9ce, 9hg, 9bre, 9vc, 9cpd, 9dxn, 9dyn, 9eep, 9hm, 9ekf, 9bal, 9cjt, 9drw, 9btz, 9cho, 9btt, 9bpa, 9aj, 9ak, 9dwn, 9day, 9eja, 9ddp, 9cvv, 9dcw, 9cyw, 9aci, 9ccs, 9abl, 9bun, 9bxq, 9dbr, 9clq, 9bfp.  
Can.—3bg, 4bk, 4ad, 4co, (5ch), 4dq, 4cn, 3oh, 4aw.

## RHAMSTINE\* VICTOPHONE

For all Phonographs and Loud-Speaking Horns

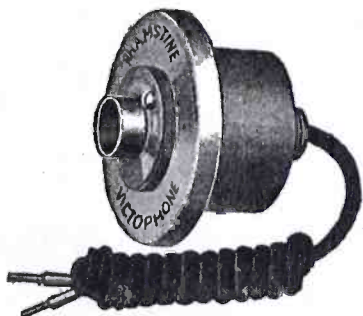

**\$7.50 Postpaid**  
Complete with Cord

In addition to the large diaphragm used in the Victophone, every other detail has been given the closest attention. When incorporated with your phonograph or horn, it will reproduce with the utmost volume and purest tone. No battery required to operate it. Your money back if not satisfied.

It can be furnished to fit all phonographs—the Standard Type fits the Victrola, Columbia, Jewett or Sonora. Specify make of phonograph when ordering. List Price, Standard Type, \$7.50.

Order the New Victophone and test it before buying any other loud speaker.

Manufactured by

### J. Thos. Rhamstine\*

500 E. Woodbridge, Detroit, Michigan  
★Maker of Radio and Electrical Products

SIX MONTHS FOR ONE DOLLAR  
"RADIO" San Francisco

## "B" BATTERIES AN EVEREADY PRODUCT

43V. Batteries, tapped.....\$5.00  
22½V. Batteries, Navy Type..... 3.00  
22½V. Batteries, Commercial Type.... 2.00

Latter two types especially adapted to Cunningham and Radiotron Tubes.  
Postage Prepaid Anywhere in U. S.

### ETS-HOKIN & GALVIN

Wireless Engineers  
10 Mission Street San Francisco

**\$4** POST PAID

**THORIO**  
-RADIO TUBES- U.S. PAT. NO. 1,220,203

1½-3-6-8-6V ¼ AMP. DETECTOR.  
FIT STANDARD SOCKET & WORK ON ANY CIRCUIT—MAIL YOUR ORDER TO  
**HAYDEN-SALES CO.**  
-JERSEY CITY-N.J.-

## 5-PLATE CONDENSERS

Given Free this Month

In return for your subscription to "RADIO" for one year. Full price \$2.50.

"RADIO"  
Pacific Building  
San Francisco

Tell them that you saw it in RADIO

By 6CTE, Brookdale, Calif.  
1bsz, 4aw, 4bz, 4my, 5aaq, 5adb, 5aes, 5aiu, 5alx, 5amu, 5be, 5ch, 5ct, 5dq, 5eh, 5ft, 5lp, 5lr, 5mm, 5og, 5qd, 5ql, 248 G's, 7af, 7abh, 7aby, 7aci, 7adf, 7adg, 7adi, 7afe, 7afk, 7age, 7aho, 7ahz, 7aim, 7aiv, 7akh, 7akk, 7ald, 7ali, 7alk, 7amu, 7bj, 7co, 7cr, 7cs, 7di, 7dr, 7dz, 7em, 7eu, 7fq, 7fr, 7fs, 7fw, 7gs, 7gu, 7gy, 7hun, 7if, 7io, 7it, 7iu, 7iw, 7jq, 7ju, 7ke, 7ks, 7lh, 7lu, 7nt, 7ob, 7om, 7ot, 7ps, 7qc, 7qd, 7qu, 7rc, 7ry, 7sh, 7ut, 7vn, 7wo, 8ago, 8cmv, 8dae, 8gh, 8kk, 8uh, 8vy, 8xan, 8yn, 8zc, 9abc, 9aec, 9aim, 9aka, 9akv, 9amb, 9amp, 9amu, 9aps, 9aqd, 9asw, 9avn, 9awm, 9awv, 9bav, 9beu, 9bfp, 9bjk, 9bly, 9bof, 9bpt, 9bpv, 9bpy, 9bqj, 9bre, 9brk, 9bto, 9btt, 9bun, 9bxa, 9bxq, 9bzi, 9caa, 9cdv, 9cdy, 9cht, 9cjc, 9cjt, 9cju, 9cjr, 9cka, 9ckj, 9cra, 9cvo, 9day, 9dbf, 9dcp, 9dgi, 9dkb, 9dkq, 9dpr, 9dpx, 9dvw, 9dwn, 9dxn, 9dxr, 9dyi, 9dyr, 9dzo, 9eak, 9ebm, 9ebt, 9eep, 9efh, 9ekf, 9eky, 9hg, 9mc, 9ql, 9rc, 9ry, 9ss.  
Can.—4co. Will qsl checks on above calls. Pse report my 50-watt C.W. and phone. Every card ansd.

By 6ARB, C. E. Duncan, 3029 Acton Street, Berkeley, Calif.  
(1ka), (1br), (1bsd), (1cpn), 1xas, 2gk, 2adk, (2brb), 2xab, (2xna), 3me, (3yo), 3zl, 3nec, (3bva), 4eb, (4xc), 5kc, 5ov, (5afh), 5aic, (5ajh), (5ajj), (5aph), 5zav, (5buo), (7abb), (8abs), 8apt, (8zk), 8ctp, 8xbh, (8xbl), (9amb), 9btl, (9caa), (9cid), (9cjr), 9clq, 9dwn, (9dyz), 9dxy.  
Can.—1bq, (3bq), 3cn, 3pz, 4eb, (4cr), 4dq, 4hh, (4io), (5sg), 9av.

At 6BBW, 234 N. Painter Ave., Whittier, Calif.  
1awi (?), (1cmx), 1ka, 2agb, 2brb, 2cee, 3gc, 3hh, (3qv), (4af), 4fz, 5agl, 5aic, (5aiu), 5ajb, 5alo, (6aju), (6cjd), (6cka), (6clb), (6gq), (6hj), (6lv), (6qh), 7fy, (7ga), 7gr, 8abs, 8cei, (8cxm), (8cyi), (8dgy), 9aec, 9aju, 9azg, 9azr, 9buk, (9bvn), 9bvz, 9byc, (9ccw), 9cea, (9cp), 9ctg, 9cwf, 9dap, (9dcj), 9ebh.  
Can.—4hh. All crds ansd.

At 6ANY-6AOF, Box 98, Hilo, Hawaii, T. H.  
5aiu, 5ajj, 5ht, 5hd, 5na, 5ql, 6aao, 6adt, 6afa, 6afg, 6age, 6ahp, 6agk, 6aiv, 6ajd, 6anu, 6aqm, 6baw, 6bdi, 6bez, 6bou, 6bo, 6bel, 6bny, 6edn, 6cer, 6cei, 6cmi, 6cmu, 6cnl, 6cnf, 6ew, 6fe, 6gu, 6gq, 6hs, 6hge, 6js, 6ko, 6la, 6li, 6lv, 6mp, 6nb, 6nl, 6np, 6oa, 6or, 6qj, 6qt, 6rf, 6rn, 6tf, 6zh, 7af, 7agz, 7ahv, 7en, 7fq, 7ma, 7mn, 7no, 7sh, 7vm, 7vt, 8atc, 8cgy, 8qu, 9apf, 9app, 9caa, 9daj, 9dny, 9dxx, 9eky, 9mm, fone 9iv, Can. 4fu. Anyone hearing my 15 watts d.c.-C. W. please qsl.

By 6EA, H. C. Seefred, 343 South Fremont Ave., Los Angeles, Calif.  
(1awe), 1bda, (1cmp), (2bcm), 3bva, 3xaq, 4io, 4xc, 5hg, (5oq), (5xt), (6fh), (6hp), (6jj), (6tu), (6zh), (6acz), (6bez), (6bmd), (6bqb), (6bql), (6cee), (6cef), (6cie), (6ckr), 7bj, 7dm, (7fr), 7gr, 7to, 7vs, (7abb), 7afe, 8bfm, 9amq, 9agl, 9bmu, (9cjt), (9csj). Any reports from far-distant points on my 5-watt tube will be greatly appreciated. After June 1st will only be "on the air" before 8:00 P.M. Reason?—Need Sleep! Will be on for DX again about October.

Continued on page 74

# We Feature the Following Equipment It Is Nationally Known—Has Reputation

**FADA NEUTRODYNE KITS \$25.00. Parts for all circuits.**  
**Kilbourne-Clark WAVE TRAPS \$8.50**

## COMPLETE SETS

Fada 120.....	\$120
Atwater Kent .....	\$104
Radyne .....	\$130
Grebe, C.R. 12.....	\$175

## COMPLETE INSTALLATIONS

We specialize in the installation of complete equipment. Get our prices, they are reasonable. The Warner Guarantee goes with it.

## LOUD SPEAKERS

Atlas Loud Speakers.....	\$25
R3, Model D.....	\$35
Magnavox M1.....	\$35
Magnavox R2 .....	\$60

*Our Line of Parts Includes Every Well Known Make*

**Remember---Our Mail Order Service is Rapid and Reliable**

FOUR  
STORES

# WARNER BROS.

FOUR  
STORES

350 Market Street

976 Market Street  
San Francisco

428 Market Street

Oakland—Twenty-second and Telegraph Avenue



# \$30.00

COMPLETE  
DELIVERED  
FREE TO YOU

## MARATHON ULTRADYNE

(SUPER HETERODYNE)

*The very newest development in Radio at an unheard of low price*

Complete set as shown above including coils and transformers ready for assembly—and with complete assembly chart, \$30.00.

This is the last word in radio. Gives you extreme selectivity, absolute clarity without noise or distortion. No antenna or ground necessary.

Every set of Marathon Ultradyne parts designed and

tested by N. E. Borch, internationally known radio engineer.

Send check or money order for \$30.00 and we will pay all transportation charges.

Or, send no money, and we will send set—you to pay postman upon arrival.

These sets are going like hotcakes. Orders filled in rotation.

**MARATHON RADIO, 579 Howard Street, San Francisco, Cal.**

Tell them that you saw it in RADIO



# SUPER HETERODYNE PARTS

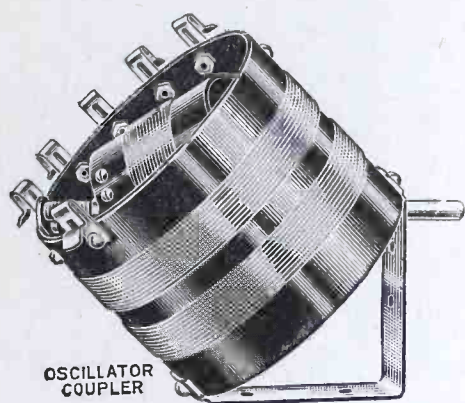

OSCILLATOR COUPLER

OSCILLATOR COUPLER, Large XX Bake-lite Black Tubing, Size 3¼x3 in., using low resistance double silk wire. Rotor, 180 degree type, 6 fanstock terminals, metal parts all nickleplated. Will improve any heterodyne set. Price \$4.00. Send for FREE Hookup Diagram.

## New York Distortionless Audio Amplifying Transformer



Ideally Suited for Super-Heterodyne Sets

**\$4.00**

The New York Audio Frequency Amplifying Transformers were designed after careful series of tests and comparisons with all other makes. They are the choice of the leading radio engineers and have repeatedly proven their exceptional amplifying qualities. Entirely free from distortion, howling and other objectionable noises.

The windings contain 4000 turns on primary and 17,000 turns on secondary of No. 40 wire, which balances out better than any other combination tried.

A closed core construction is employed, eliminating more than one-half of the magnetic joints usually employed, thus greatly increasing efficiency. They occupy small space; are sold with money-back guarantee. Operate with equal efficiency any style tube.

Price \$4.00

## 4 Transformers and Oscillator Coupler \$20.00

Send for free lay-out and operating instructions.

## New York Mica Fixed Condensers

"More Uniform Capacity"

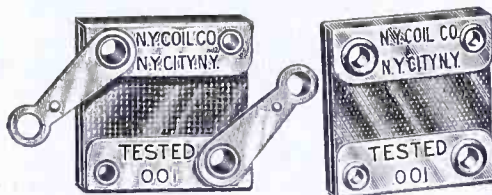

Adapted by Leading Heterodyne Manufacturers on account of truthful capacity rating. This is the only laboratory precision-built condenser on the market, yet sold at a commercial price. It is standard equipment with some of the largest and most discriminating set manufacturers.

Guaranteed for capacity and against leakage or breakdown.

The following sizes always in stock:

Capacity	Retail Price
.0001 Mfd.	.35
.00015 "	.35
.00025 "	.35
.0005 "	.35
.001 "	.40
.002 "	.40
.005 "	.60
.006 "	.75
.00025, with Grid Leak Mounting attached, 45c list.	

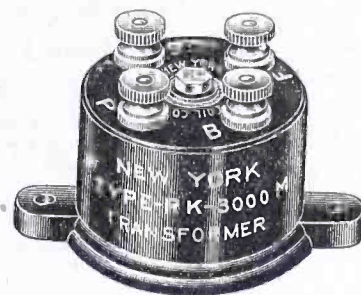

Price \$4.00

NEW YORK COIL, 3,000 Meter R K. TYPE, INTERMEDIATE FREQUENCY TRANSFORMERS are marvels of efficiency. Scientific positioning of primary and secondary, together with their extreme low height—1¼ in.—allows shorter grid and plate, wire connections than found in any other manufactured.

## TYPE 4

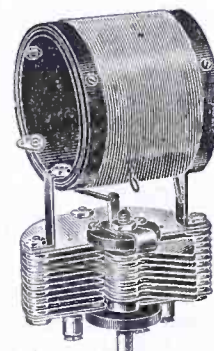

NEW YORK COIL CO.

NEW YORK Condenser Tuned Radio Frequency Transformers are designed to operate in popular present-day circuits. Electrical losses, such as distributed capacity, have been reduced to the minimum.

The transformer is rigidly secured to our universally known New York Variable Condenser of 17 plates, which will tune sharply all wavelengths from 250 to 575 meters.

Price, including Condenser, \$4.50.

## NEW YORK COIL COMPANY

338 PEARL STREET

Pacific Coast—MARSHANK SALES CO., 1240 S. Main St., Los Angeles, Calif.

NEW YORK CITY, N. Y.

## Why Not Use All CHELTEN Quality Radio Apparatus

### The Microfarad Junior

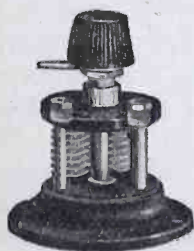

Designed as a Neutralizing Condenser of Low Capacity. Has nine plates adjustable by a knob without danger of body capacity. Absolutely retains adjustment. Priced at \$1.75. Listed below are other Chelten Quality Radio Apparatus obtainable at your dealers.

- MIDGET VERNIER CONDENSER.
- RADIOSCOPE CONDENSER with vernier.
- SPECIAL CONDENSER for high oscillating radio-frequency circuits.
- All types of VARIABLE CONDENSERS.
- JACKS and PLUGS, Vacuum tube SOCKETS.
- CRYSTAL DETECTORS.

Write for Illustrated Catalog.

## CHELTEN ELECTRIC CO.

4865 Stenton Ave., Philadelphia

Tell them that you saw it in RADIO

**MAGNETIC CONTROL**

*Continued from page 26*

one is made double-throw by providing two additional contacts, as will be seen in the illustration. To prevent chattering or contact-rebound, a spring arrangement engages one end of the levers actuating the fibre mountings. The form adopted by us is shown in Fig. 4, a U-shaped affair. This is positive restraint in both directions and is practically in no danger of change as to adjustment.

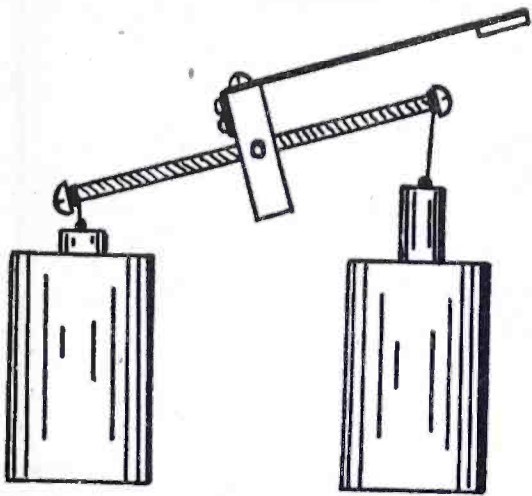

Fig. 5. Contact Unit in "Off" Position

In Fig. 5 one gets an idea as to the assembly of a block and the method of harnessing the underlying magnets for the ON and OFF positions. The use of short thongs of rawhide between the block lever and plunger is recommended.

In connecting up to the storage battery Fig. 6 may be followed. One side of each magnetic unit is connected to a common battery lead, and the buttons are attached at one connection to a common lead. Since the current consumption is but 2 amperes, and that momentary, the battery will not be hurt,

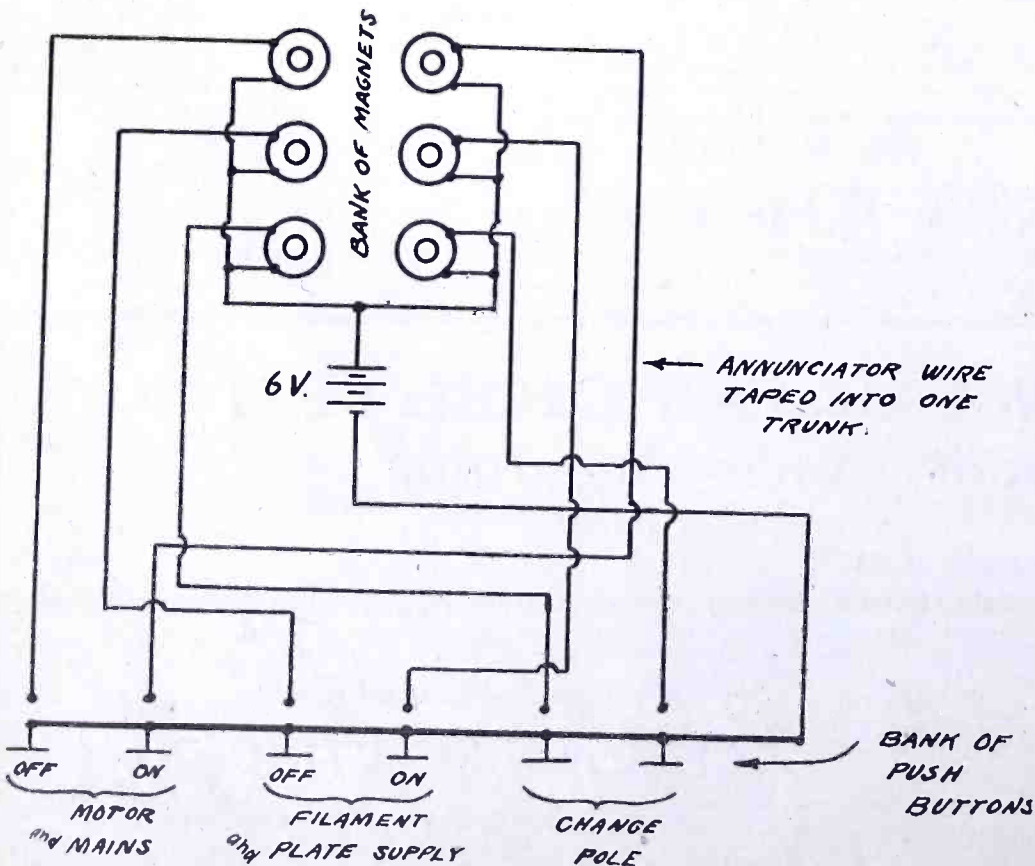
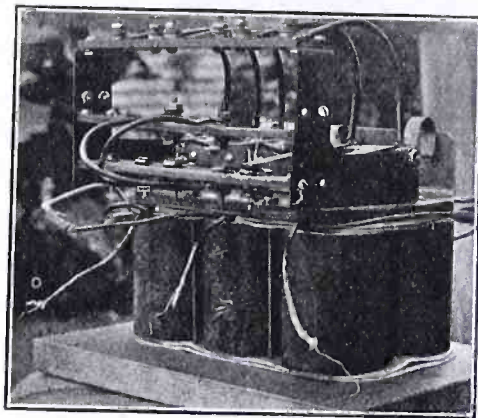

Fig. 6. Wiring Diagram for Actuating Magnets

but the push button contacts should be husky enough to withstand unlimited service, so we installed the regulation door bell buttons, with frames of "moulded mud."

Of course many do not use a "sink" rectifier, therefore the "change pole" unit will not be essential per se. With the need for high voltage d.c. the sink gives freedom from heating, etc., and is infinitely more stable than the chemical rectifier. Where large tubes are in operation it would appear that this method has much to recommend it over its com-



Front View of Switch

only remains to install a thermo-element in the antenna, with the ammeter in

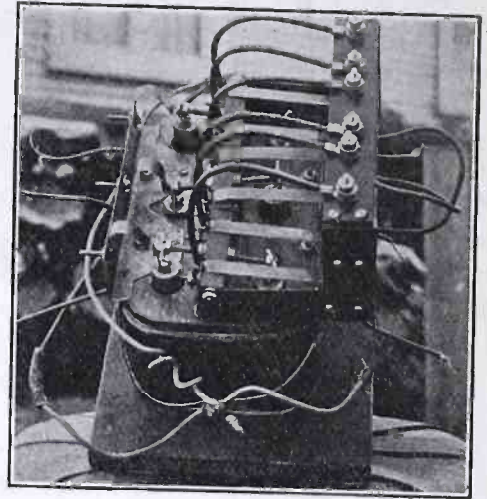

Top View of Switch

front of the operator and the story is complete. A dependable circuit with stable adjustment need cause no worry, however, and the receiver is a perfect index as to what is going on at the "business end."

**CIVIL SERVICE EXAMINATION FOR RADIO ENGINEERS**

The United States Civil Service Commission announces an open competitive examination for radio engineer, \$4,000 to \$5,000 a year, associate radio engineer, \$3,000 to \$4,000 a year, and assistant radio engineer, \$2,000 to \$3,000 a year. Receipt of applications will close July 1. The examinations are to fill vacancies in the Department of Engineering, Navy Yard, Washington, D. C., in the Naval Research Laboratory, Bellevue, D. C., and vacancies in the Federal classified service throughout the United States at the salaries indicated above.

The duties of the positions are to conduct or superintend the development, design, construction, installation, standardization, and the writing of specifications for practical and special apparatus and methods of radio communication, such apparatus to include sets for land use for more or less permanent stations, also for portable land stations, and for airplane and ship sets; to carry out advanced technical work in radio research; to analyze the data accruing from observations of the operation of various radio apparatus and installations; to make recommendations as to policy, apparatus, or installation in accordance with inspections; to plan and execute experimental investigations; and to perform other related work.

Competitors will not be required to report for examination at any place, but will be rated on their education and preliminary experience, special experience and fitness, and publications, reports, or thesis to be filed with the application.

Full information and application blanks may be obtained from the United States Civil Service Commission, Washington, D. C., or the secretary of the board of U. S. civil service examiners at the post office or custom house in any city.

**A GOOD ONE-TUBE PORTABLE**

By PHILIP N. EMIGH

I have built a one-tube portable set that has given surprising results as to distance and selectivity. It requires no ground, and, with a 50-ft. wire thrown over a tree, it brings in broadcast stations 600 miles away. It gives the audibility of a single circuit with the selectivity of a three-circuit tuner. Naturally far better results are secured with a regular antenna.

Although the hook-up looks like an untuned primary circuit, yet the primary is tuned sharply with the secondary condenser because of the connection between the primary and grid.

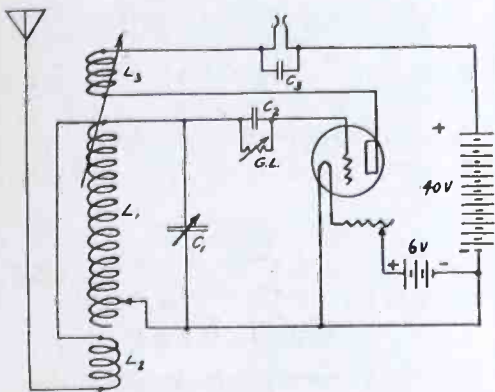

Hook-up for Simple One-Tube Portable Receiver

The secondary inductance  $L_1$  consists of 60 turns of No. 24 SSC wire wound on a 3½-in. by 4½-in. bakelite tube. It is tapped at 0, 5, 10, 15, 30, 45 and 60 turns. A ½-in. space is left at the 15th turn for the tickler shaft. The primary  $L_2$  is wound on the same tube ½ in. below the secondary winding. It consists of 5 to 10 turns of home-made "litz."

This "litz" cable may be made up from about 20 ft. of No. 36 SSC wire, which may be taken from the secondary winding of an old Ford coil. String this wire back and forth between two stout nails until there are 60 strands and then twist it into a cable, fastening one end in a hand drill and the other to a small hook made from a nail.

The tickler,  $L_3$ , consists of 40 turns of No. 24 SSC wound on a standard wood rotor which is mounted inside the secondary winding.  $C_1$  is a 23-plate variable condenser,  $C_2$  a .00025 mfd. grid condenser, and  $C_3$  a .0005 to .0025 mfd. by-pass condenser. The whole set may be mounted on a 6-in. x 8-in. panel. The windings specified give a range of from 75 to 600 meters.



—and listen to the difference!

2000 OHMS  
16000 TURNS  
3200 OHMS  
2,500 TURNS

GREAT VOLUME. PERFECT REPRODUCTION

**Wise Listeners Use These Better Phones**

T-B-H Phones are the best. They will not rattle or distort even on two stages of amplification.

If your dealer does not carry them, order direct from us. Send no money, just pay the Postman when he delivers them.

We pay the postage.

Write for Circular Giving Your Dealer's Name

Distributed by  
Donaldson Radio Company  
Kansas City, Mo.  
Rumsey Electric Company  
Philadelphia, Pa.  
V. R. & A. C. Johns  
Auckland, New Zealand

**The T. B. H. CORPORATION**  
DANSVILLE, N. Y.

**IF YOU WANT A TRANSFORMER**

"that makes it clear when you're near"

USE A JEFFERSON

"to bring them in just as clear from afar"

USE A JEFFERSON

"that has just the right characteristics to meet your particular requirement—two radio—six audio frequency"

USE A JEFFERSON

"that is made by a company who have specialized in this field for more than a generation"

USE A JEFFERSON

The Name JEFFERSON is Known Wherever Transformers are used.

You are invited to write our Radio Engineering Department for amplification data. Attractive descriptive literature is also available. This service is gratis.

**Jefferson Electric Mfg. Co.**

424 S. GREEN ST., CHICAGO

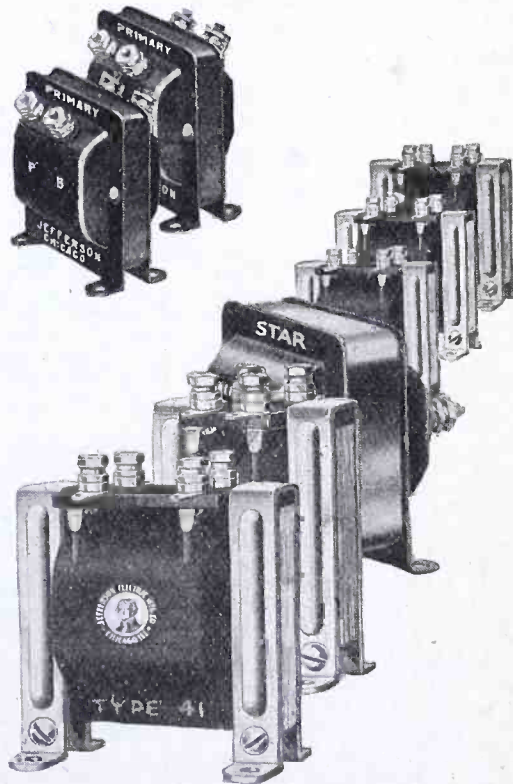

**RADION**  
The Supreme Insulation  
Panels, Dials, Sockets,  
Knobs, Insulators  
American Hard Rubber Co. 11 Mercer St. N. Y.

**RADIO MAP OF THE U. S. 35c**  
For Sale by  
**Pacific Radio Pub. Co., Inc., San Francisco**

Tell them that you saw it in RADIO

# RADIO ADS

**A CLASSIFIED ADVERTISING SECTION READ BY BETTER BUYERS**

The rate per word is five cents net. Remittance must accompany all advertisements.  
Include name and address when counting words.

**ADS FOR THE AUGUST ISSUE MUST REACH US BY JULY FIRST**

**158 GENUINE Foreign Stamps.** Mexico War Issues. Venezuela, Salvador and India Service. Guatemala, China, etc., only 10c. Finest approval sheets 50 to 60%. Agents Wanted. Big 72-p. Lists Free. We Buy Stamps. Established 20 years. Hussman Stamp Co., Dept. 150, St. Louis, Mo. (3T)

**PATENTS PROCURED.** Send sketch or model today for examination, prompt report and advice. No charge for preliminary advice. Write for free Booklet and blank form on which to disclose your idea. Highest references. Promptness assured. Clarence A. O'Brien, Registered Patent Lawyer, 198-C Security Bank Building. Directly across the street from Patent Office, Washington, D. C.

**AMERICAN MADE TOYS**—Manufacturers on large scale, and others wanted to manufacture metal toys and novelties. Millions needed of barking dogs, wag tail pups, wild animals, automobiles, Indians, cowboys, baseball players, cannons, toy soldiers, crowing roosters, statues of Liberty, miniature castings of capital, battling girl souvenirs and others. Unlimited possibilities. Guaranteed casting forms furnished manufacturers at cost price from \$5.00 up, with complete outfit. No experience or tools necessary. Hundreds made complete per hour. We buy goods all year and pay high prices for finished goods. Cash on delivery. Contract orders placed with manufacturers. Catalog and information free. Correspondence invited only if you mean business. Metal Cast Products Co., 1696 Boston Road, New York.

**MAKE BIG MONEY OUT OF RADIO**

Thousands of People want to buy a good Radio instrument. They have read that vast improvements have been made and they are ready to buy now if you show them the best.

It is one thing to make a good radio instrument for your own amusement, but why not cash in now on your experience? Let us send you full particulars of the Ozarka Plan which shows you how to

**"MAKE \$120 WEEKLY"**

selling long-distance Radio sets. The season is on right now. Let us tell you how to combine the clear signal of the crystal detector with the distance of the vacuum tube. Write today and don't fail to give the name of your county.

**OZARKA INCORPORATED**  
814 Washington Blvd., Chicago

**C. W. and RADIO PHONISTS**—Our new converters will satisfy your need for a more efficient and durable direct current plate supply. No armatures to burn out. Output from seven hundred to two thousand volts at 4 amperes. Synchronous Motors, Transformers and other parts sold separate. Write immediately. Kimley Equipment Mfg. Co., 290 Winslow Ave., Buffalo, N. Y. (tc)

**ARC & SPARK SYSTEMS**

Send for Descriptive Circular R.D.

Interesting and Instructive (tc)  
Pacific Radio School 433 Call Bldg., San Francisco

**RADIO WORLD, THE GREAT NATIONAL WEEKLY**—published every seven days with all the latest news, developments and pictures of the radio field. 15c a copy. \$6.00 a year (52 numbers), \$3.00 six months, \$1.50 three months. Special to radio readers. Send \$1.00 and we will send you the next eight issues of RADIO WORLD. Pub. Office, 1493 Broadway, New York. (tc)

**Vacuum Tube Hospital**

We repair and guarantee them.

Agents, Dealers, and Customers Wanted.

Radiotube Co., 903 Broad St., Newark, N. J. to

**TELEGRAPHY**—Morse and Wireless—taught at home in half usual time and at trifling cost. Omnigraph Automatic Transmitter will send, on Sounder or Buzzer, unlimited messages, any speed, just as expert operator would. Adopted by U. S. Government and used by leading Universities, Colleges, Technical and Telegraph Schools throughout U. S. Catalog free. Omnigraph Mfg. Co., 16 J. Hudson St., New York City.

**BIG Money and Fast Sales**—every owner buys gold initials for his auto. You charge \$1.50, make, \$1.44. 10 orders daily easy. Samples and information free. World Monogram Co., Dept. 68, Newark, N. J. (SAS)

If your Neutrodyne won't "Neut" o. k., send 10c for details of Kladag Coast To Coast Circuit, bill of materials, etc., to change over your Neut into a set that will bring them all in from Mexico City to Tunucu, Cuba, on a loud speaker. Or send \$5.00 for all extra parts, blue print, etc., you need to do this. Uses same panel layout. Stamps accepted. Radio List for stamp. Kladag Radio Laboratories, Kent, O. in

**RADIO GENERATORS**—500V 100 watt \$28.50. Battery Charging Generator \$8.50. High Speed Motors. Motor Generator Sets, all sizes. MOTOR SPECIALTIES CO., Crafton, Penna. (tc)

**COMPLETE 3-Tube Radio Set,** Magnavox R-3, Storage Battery, B Batteries and Aerial. Only \$125.00. For information, write Albert Roof, Ottawa, Ohio.

**1500 VOLTS FOR \$45 ! ! ! ! !**  
**BRAND NEW General Electric** ball bearing dynamos, built to Navy specifications for plate supply for transmitting tubes. Intended to run from a 25 volt storage battery, and will deliver nearly twice the normal rating of 233 milliamps. (600 watts). Can also be furnished at \$3.00 extra, with shafts extended permitting driving by an external source, such as a gas engine, motor or anything else you have. When driven this way, can be used to light tube filaments, charge storage batteries, and do anything else a high grade 25 volt shunt wound generator would do. Speed 6,000 RPM. Will make a pair of 50 watters make a noise like a 250 watter! D. B. McGOWN, 1247 Forty-seventh Avenue, San Francisco, Calif.

**FOR SALE CHEAP.** New Murdock loud speaker, head phones and Cunningham 299 tube. Earl Haynes, Owensboro, Ky.

**AGENTS**

Sell, **BIG-BEN** Radio Crystal Receiving Sets, guaranteed sample and working outfit to agents (\$1.00) prepaid. **SOUTHERN SALES CO.,** Box 217A, Washington, D. C.

**I HAVE INVENTED A TELEPHONE RECEIVER EAR PROTECTOR**

(Patent applied for)

I was thinking of persons that refuse to sit or be near people suffering of non contagious troubles and these very same persons, however, **DO NOT PAY ATTENTION TO THE FACT OF BRINGING A TELEPHONE OR RADIO RECEIVER IN CLOSE CONTACT WITH THEIR EARS IN SPITE OF NOT KNOWING WHO USED SAID RECEIVERS BEFORE ! ! !**

**I AM A PHARMACIST GRADUATED IN PORTO RICO AND JEFFERSON CITY, MO. THEREFORE, I KNOW WHAT CONTAGION MEANS.**

My protector is just a device made of sanitary paraffined white paper, crimped and pressed into the proper shape to frictionally engage the whole ear part of the receiver, when pressed upon same and which makes impossible all contact between phone and ear.

This protector is designed to be used but once, so each person uses a new protector and therefore **DANGER OF DISEASES OR CONTAGION IS ABSOLUTELY OBTATED.** Its application? Oh, it is very simple: you place one protector on the palm of your left hand and gently press the ear part of the phone into it with your right hand.

Millions of people use every day telephone or radio receivers and when they bring such in close contact with their ears, you can see on their faces how they hesitate distrustfully: **IT IS JUST NATURAL SELF PROTECTION,** for they just think who knows how healthy might be the previous user of those receivers. I am ready to grant a Royalty to manufacture and sell my invention on basis of reasonable and honest dealing.

I would like to meet some reliable party interested in the business.

Address:

**JOSE A. DOMINGUEZ,**  
71 Mendez Vigo Street,  
**MAYAGUEZ, PORTO RICO**

**RENEW DRY CELLS.** Process 10c. Universal, 650 Center, Waukegan, Illinois.

**MAGNAVOX M4.** Latest nationally advertised battery-less reproducers. Magnetically balanced. Sensitive. Improved rubber cushioned diaphragm. List \$25. Introductory \$21. Radio Central, Dept. P, Abilene, Kansas.

**MAGNAVOX R3.** New but older model. Has crystal finish horn. Big bargain at \$17.50. Sent COD. Van Blaricom Co., Helena, Mont.

**RAY-DEE-ARTCRAFT SUPER-HETERODYNE KIT:** 4 Type 10-A Intermediate Freq. TUNED RF TRANSFORMERS (Tuned! Get that?) ..... \$28.00 (The above transformers have bakelite housings.)  
1 OSCILLATOR COUPLER ..... \$5.00  
1 FRAMEWORK FOR LOOP (knocked down) .. \$2.50  
Blueprint, size 12" by 22" of 8 tube Super-heterodyne Circuit ..... \$0.50  
Total ..... \$36.00

**THIS MONTHS SPECIAL ONLY** ..... \$25.00  
Guaranteed satisfactory or money refunded.  
Remit by M. O. or certified check.  
**RAY-DEE-ARTCRAFT INSTRUMENT CO.**  
1005-17 Tribune St. Redlands, Calif.

# ! FREE !

## RADIO LOG BOOK

For Recording Stations Heard. This Book Free With Only One Subscription to "RADIO" for 6 Months—\$1.00.



### Other Free Premiums—

- 5 Plate Variable Condenser
- Copy of "Elements of Radio Communication" by Stone
- Induction Filter
- Radio Map of U. S.
- "The Radiobuster"

Send \$2.50 and get "RADIO" for one full year and your choice of one of these premiums.



**"RADIO"**  
Pacific Building  
San Francisco, Cal.

Tell them that you saw it in RADIO



# A Radio Library for only \$3.75

ONE practical book on radio communication—another big book of humorous radio sea stories—a radio log book for keeping your records—a large radio map of the U. S.—a copy of the “ABC OF RADIO”—and the Radio Atlas of the World—all for \$3.75! You can’t get a better radio library for the money. This big offer will solve your book problems.

This Offer Good Only  
Until August Fifteenth

## All of These Books for \$3.75

“ELEMENTS OF RADIO COMMUNICATION”

by Lieut. E. W. Stone

“THE RADIOBUSTER”

by Volney G. Mathison

“ABC OF RADIO”

RADIO LOG BOOK

RADIO ATLAS OF WORLD

RADIO MAP OF THE U. S.

This combination of books makes a dandy radio library. The regular price, if purchased separately, is \$4.75. This offer saves you one dollar.

*Library Sent Anywhere by Prepaid Parcel Post*

**THE COUPON SAVES YOU \$1.00**

“RADIO”, Pacific Building, San Francisco, Cal.

I enclose \$3.75 in full payment for which you will immediately send me, parcel post prepaid, the following radio books: “Elements of Radio Communication”—“The Radiobuster”—“ABC of Radio”—Radio Map of the U. S.—Radio Log Book—Radio Atlas of the World.

Name ..... Street and No. ....

City ..... State .....

Tell them that you saw it in RADIO

# For Summer Radio

## Bradleyleak

THE PERFECT GRID LEAK

Range— $\frac{1}{4}$  to 10 Megohms.  
A grid condenser of 0.00025  
mf. supplied extra. Endorsed  
by Cockaday, Amrad,  
Flewelling, Crosley, etc.  
Price - - - \$1.85  
Condenser - .35

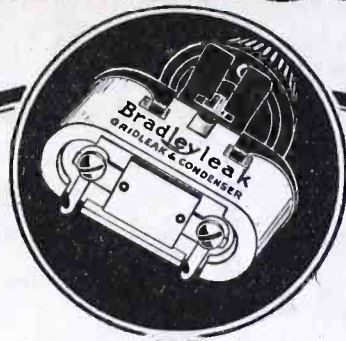

## Bradleystat

REGISTERED U.S. PAT. OFF.  
PERFECT FILAMENT CONTROL

Noiseless, stepless filament  
current control for ALL  
tubes. Is standard equip-  
ment on many sets, includ-  
ing Amrad Console models.  
Price - - \$1.85



## Bradleyohm

THE PERFECT RESISTOR

An adjustable resistor for ra-  
dio circuits. Made in three  
ranges:  
10,000 to 100,000 ohms  
25,000 to 250,000 ohms  
50,000 to 500,000 ohms  
Price, any range, \$2.00

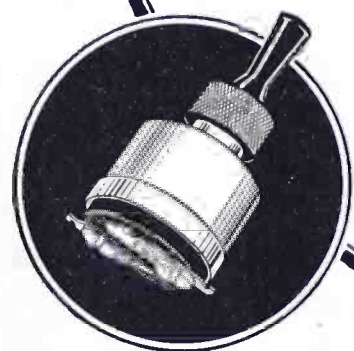

The Bradleystat holds first  
place for long distance re-  
ception in many contests.

## Bradleyswitch

PERFECT BATTERY SWITCH

For A- and B-battery circuits.  
Only ONE hole required in  
panel to mount the switch.  
Nickel-plated and totally en-  
closed.  
Price - - - 60c

## Bradleyometer

THE PERFECT POTENTIOMETER

A stepless, non-inductive po-  
tentiometer for all radio cir-  
cuits. Complete range in half  
turn of knob. Made in 200 and  
400 ohms. Price, 200 ohm,  
\$2.00; 400 ohm, \$3.00.



# Use Allen-Bradley Products

Summer Radio Sets are portable sets! This means that they must be built for abusive service, and must operate under conditions that are often unfavorable for good reception. Short antenna, loop antenna, and similar receptive devices call for extremely sensitive sets. This, again, means that the parts used must be of high efficiency for maximum signal strength.

Allen-Bradley Radio Products are known the world over for excellence of construction and perfection in operation. They make any good set better, and insure a full measure of enjoyment in summer camps when used in portable sets.

Make your set a *good* set. The above radio parts are the finest obtainable. Follow the advice of radio experts. Use them!

Allen-Bradley Co.,  
288 Greenfield Ave., Milwaukee, Wis.

Please send me a complete set of your descriptive circulars on Allen-Bradley radio products.

Name .....

Address .....

Allen-Bradley Co.  
Electric Controlling Apparatus

288  
Greenfield  
Ave.  Milwaukee,  
Wis.

### The Allen-Bradley Guarantee

Every Allen-Bradley radio product is guaranteed for ONE YEAR against defects in material and workmanship. Any defective material will be repaired or replaced, without charge, within the guarantee period.

Tell them that you saw it in RADIO

# LOW LOSS

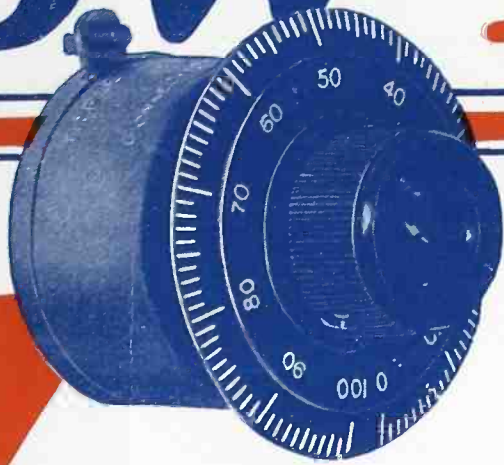

0.1  
ohm

AMATEUR  
150 RANGE 220

226

BROADCAST RANGE

546

## The Test That Tells the Truth

The test which established the resistance of the

### CONNECTICUT

#### Triple Range Variable Condenser

as 0.1 ohm at a capacity of 330 micro-microfarads on a 215 meter wave length shows this to be one of the most efficient instruments of its kind yet developed.

This was a real test—and it tells a real story.

Had it been made in the usual way—by measuring the resistance of the condenser at a certain capacity at 1,000 cycles, audio frequency—it would not give you any more than a general idea of its efficiency—

But because the test was made at a wave length well within the range of amateur and broadcast work—

Because the resistance was measured at radio—not audio-frequency—and

Because the result obtained was secured under the same identical conditions you encounter in every day receiving—

It not only gives you an accurate indication of the losses in this instrument but it gives you a true idea of the extent to which it will increase the selectivity and the signal strength of your set.

#### Triple Range—Three Condensers in One

This is the condenser which enables you—by a few simple changes in the wiring connections, to cover the full field of usefulness with a single instrument.

It is three condensers in one.

The chart tells the story —

The range indicated by Curve B — from .000075 to .000275 mfd. — approximately that of an eleven plate condenser, is secured by wiring into the circuit from posts G and B. The range indicated by Curve A — from .0001 to .0006 mfd. — approximately that of a twenty-three plate condenser, is secured by wiring into the circuit from posts G and A.

The range indicated by Curve AB — from .00015 to .00085 — approximately that of a forty-three plate condenser is secured by bussing A and B and wiring into the circuit from G and B.

**FEATURES: Vernier Scale—Complete Shielding—Compact Size  
And all the convenience that goes with One-hole Mounting**

**PRICE \$4.50**

Complete with dial, index stud, spacing washers and buss bar.

Send for Bulletin A-104 describing this unique instrument, with information and diagrams illustrating its special applications.

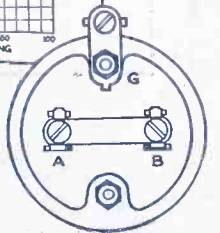
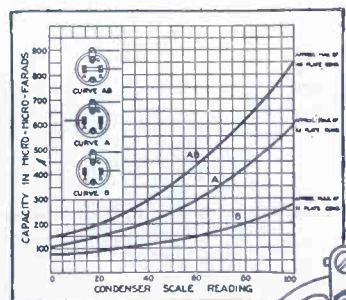

**CONNECTICUT**  
MERIDEN

**TELEPHONE  
& ELECTRIC**  
RADIO DIVISION

**COMPANY**  
CONNECTICUT



# SUPER-HETERODYNE

DISTANCE  
SIMPLICITY  
VOLUME

The ideal radio receiver. That most sensitive of all circuits devised for extreme long distance reception with small loop antenna and dry cell tubes.

TRULY A  
REMARKABLE  
RECEIVER

## THE "PACIFIC QUINTET" SUPER-HET KIT \$15.00

Another Leader Product of the Popular "Pacific" Line

AN UNUSUAL VALUE, made possible through huge quantity production. For the experimenter or anyone who wishes to construct an economical but efficient Super-Heterodyne receiving set. Not a toy or midget outfit but finely finished merchandise built for real work.

### SATISFACTION GUARANTEED

BUILD YOUR OWN SUPER-HETERODYNE. Rebuild or convert your old set to a modern and advanced type Super-Heterodyne. All other parts required are standard. HOOK UP PRINT and simple instructions packed with each "PACIFIC QUINTET" KIT. Order from your regular dealer or

SENT TO ANY ADDRESS Upon Receipt of \$15.00 or by Parcel Post or Express C.O.D.



### SUPERIORITY

ACKNOWLEDGED BY THOSE WHO KNOW

These remarkable transformers are acclaimed by all who use or hear them to be the very best to be had at any price. Their wonderful tone quality and splendid performance are simply a revelation to every one. Beauty of design, with rich black nickel trimmed finish, make this precision equipment an added attraction in the finest set. Made especially for those who demand only the best that can be made regardless of price.



**FREE**  
Super-Heterodyne Hook-Up  
Print packed with each transformer.

No. 5 PACIFIC S-H SUPER-Heterodyne Amplifying Transformer (2 or 3 required), each \$6.50.

No. 10 PACIFIC S-H SUPER-Heterodyne Transformer Standard for input or output, each \$6.50.

At your Dealers or shipped to any address upon receipt of price or by Parcel Post or Express C.O.D.

## MAKE RADIO A PLEASURE WITH BALDWIN-PACIFIC "NOISE FILTER" NO. 15

No more "Night-mare" reception if you use this device. Electrical interference from high voltage lines, telephone wire disturbances, farm lighting plants, dynamos, elevators, generators, etc., completely eliminated.

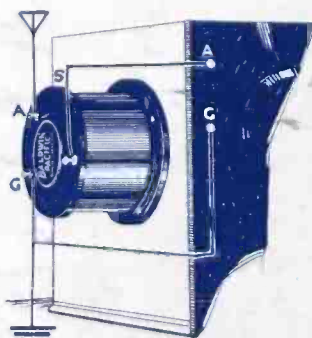

This is a real "Noise Killer" that makes receiving a pleasure under conditions ordinarily impossible. A small compact and attractive unit, easily and quickly attached. May be used inside set if desired.

### SATISFACTION GUARANTEED—WITHOUT RESERVATION

Thousands of these filters are in use. All owners praise them. We have yet to hear of a dissatisfied customer. At your dealer's or shipped to any address upon receipt of \$6.50 or by Parcel Post or Express C.O.D. If not thoroughly satisfied your money promptly refunded.

#### OF IMPORTANCE TO THE RADIO PUBLIC

The Baldwin-Pacific Line is a quality line throughout. Every item built to the highest standard of efficiency from only the best materials. Scientific design, expert workmanship and attractive appearance prevails. Made for those who want the best and the greatest value for their money. The broad guarantee of absolute satisfaction prevails.

**BALDWIN  
PACIFIC**  
QUALITY GUARANTEED  
SAN FRANCISCO

**Baldwin-Pacific & Co.**  
Manufacturers - Representatives - Distributors  
Pacific Building San Francisco

#### JOBBERS and DEALERS

Right policy, attractive prices and guaranteed quality apply to this line. Strong publicity to follow—trade paper, show cards, etc. Order now for prompt delivery.

Los Angeles  
1111 S. Wall St.

Indianapolis  
336 Burgess Ave.

New York  
331 E. 84th St.

Philadelphia  
4241 Sansom St.

Boston  
100 Boylston St.